

Use & Care Guide

30" Free-Standing Wave-Touch™ Electric Range
with Induction Cooktop

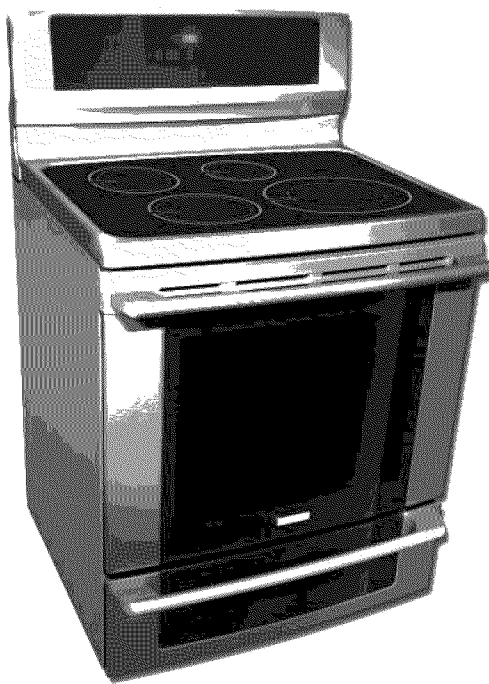

 **Electrolux**

P/N 316471013

2 Finding Information

Table of contents

Finding information	2
SAFETY	3-5
Features	6-9
Getting Started	10-11
• Power up, control display modes & timers	10
• Control lock & oven lights	11
Settings for Best Results	12-13
Induction Cooking	14-15
Setting Induction Controls	16-19
• Power sharing	19
Setting Oven Controls	20-42
• Rapid preheat	20
• Bake	21
• Using cook time	22
• Using cook time with end time	23
• Broil	24-25
• Convection bake	26
• Using convection convert	27
• Convection roast	28-29
• Probe	30-31
• Convection broil	32
• Keep warm	33
• Slow cook	34
• Perfect Turkey™	35
• Defrost	36
• Dehydrate	36-37
• Bread proof	37
• Saving & recalling my favorite recipes	38
• Multi stage cooking	39-40
• Setting Sabbath mode	41-42
Setting Lower Oven Controls	43-45
• Bake	43-44
• Keep warm	44-45
Setting Your Preferences	46-51
• Setting clock	46
• Setting clock display (CLO)	46
• Setting 12 or 24 hour mode (CLO)	47
• Changing between F° or C° (F-C)	47
• Setting 12hr energy saving mode (ES)	48
• Setting audio mode (AUD)	48
• Adjusting oven temperature (UPO)	49
• Adjusting lower oven temperature (UPO)	49
• Factory default reset (RST)	50
• User preferences chart	51
Self-Clean	52-53
Care & Cleaning	54-61
• Cleaning recommendations	54-55
• Cooktop maintenance	56
• Cooktop cleaning	56-57
• Oven door removal	58-59
• Changing oven lights	60-61
Solutions to Common Problems	62-65
List of displayed abbreviations	66
Warranty	67

Please read & save this guide

Thank you for choosing **Electrolux**, the new premium brand in home appliances. This *Use & Care Guide* is part of our commitment to customer satisfaction and product quality throughout the service life of your new appliance.

We view your purchase as the beginning of a relationship. To ensure our ability to continue serving you, please use this page to record important product information.

Keep a record for quick reference

Purchase date

Electrolux model number

Electrolux serial number

NOTE

Registering your product with Electrolux enhances our ability to serve you. You can register online at **www.electroluxappliances.com** or by dropping your Product Registration Card in the mail.

Questions?

For toll-free telephone support in the U.S. and Canada:

1-877-4ELECTROLUX (1-877-435-3287)

For online support and Internet production information visit <http://www.electroluxappliances.com>

Important safety instructions

Recognize safety symbols, words and labels

Safety items throughout this manual are labeled with a WARNING or CAUTION based on the risk type as described below:

WARNING

This symbol alerts you to situations that may cause serious body harm, death or property damage.

CAUTION

This symbol alerts you to situations that may cause bodily injury or property damage.

Read all of the following safety instructions before using this appliance:

- **Remove all tape and packaging before using the range.** Destroy the carton and plastic bags after unpacking the range. Never allow children to play with packaging material.
- **Proper Installation— Be sure your appliance is properly installed and grounded by a qualified technician in accordance with the National Fuel Gas Code ANSI Z223- latest edition, or in Canada CAN/CGA B149.1 and CAN/GGA B149.2, and the National Electrical Code ANSI/NFPA No.70-latest edition, or in Canada CSA Standard C22.1, Canadian Electrical Code, Part 1, and local code requirements.** Install only per installation instructions provided in the literature package for this range.

Ask your dealer to recommend a qualified technician and an authorized repair service. Know how to disconnect the power to the range at the circuit breaker or fuse box in case of an emergency.
- **User servicing— Do not repair or replace any part of the appliance unless specifically recommended in the manuals.** All other servicing should be done only by a qualified technician. This may reduce the risk of personal injury and damage to the range.
- **Never modify or alter the construction of a range by removing leveling legs, panels, wire covers, anti-tip brackets/screws, or any other part of the product.**

WARNING

- All ranges can tip.
- Injury to persons could result.
- Install anti-tip device packed with range.
- See Installation Instructions.

To reduce the risk of tipping, the range must be secured by properly installed anti-tip bracket provided with the range. To check if the bracket is installed properly, visually check that rear leveling leg is inserted into and fully secured by the anti-tip



bracket by removing lower panel or storage drawer. For models with a lower oven or warmer drawer, grasp the top rear edge of the range and carefully attempt to tilt it forward. Refer to the installation instructions for proper anti-tip bracket installation.

This appliance has been tested and found to comply with the limits for a class B digital device, pursuant to Part 18 of the FCC rules. These limits are designed to provide reasonable protection against harmful interference in a residential installation. This unit generates, uses and can radiate radio frequency energy and, if not installed and used in accordance with the instructions, may cause harmful interference to radio communications. However there is no guarantee that interference will not occur in a particular installation. If this unit does cause harmful interference to radio or television reception, which can be determined by turning the unit off and on, the user is encouraged to try to correct the interference by one or more of the following measures:

- Reorient or relocate the receiving antennae.
- Increase the distance between the unit and receiver.
- Connect the unit into an outlet or a circuit different from that to which the receiver is connected.

CAUTION

Persons with a pacemaker or similar medical device should exercise caution using or standing near an induction unit while it is in operation, as the electromagnetic field may affect the working of the pacemaker or similar medical device. It would be advisable to consult your Doctor or the pacemaker or similar medical device manufacturer about your particular situation.

Save these instructions for future reference.

Important safety instructions

WARNING

- **Never Use Your Appliance for Warming or Heating the Room.**
- **Do not use the oven or Warmer Oven/Lower Oven (if equipped) for storage.**
- **Stepping, leaning or sitting on the doors or drawers of this range can result in serious injuries and also cause damage to the range.** Do not allow children to climb or play around the range. The weight of a child on an open door may cause the range to tip, resulting in serious burns or other injury.

CAUTION

Do not store items of interest to children in the cabinets above a range or on the backguard of a range. Children climbing on the range to reach items could be seriously injured.

- **Do not leave children alone—Children should not be left alone or unattended in the area where appliance is in use.** They should never be allowed to sit or stand on any part of the appliance.
- **Remove the oven door from any unused range if it is to be stored or discarded.**
- **Storage in or on Appliance—Flammable materials should not be stored in an oven, lower oven drawer, near surface units or in the storage drawer.** This includes paper, plastic and cloth items, such as cookbooks, plasticware and towels, as well as flammable liquids. Do not store explosives, such as aerosol cans, on or near the range.
- **Protective liners—**Do not use aluminum foil to line the oven bottom, except as suggested in the manual. Improper installation of these liners may result in a risk of electrical shock, or fire.
- **DO NOT TOUCH SURFACE COOKING ZONES, AREAS NEAR THESE ZONES, OVEN HEATING ELEMENTS OR INTERIOR SURFACES OF THE OVEN.** ALL surface cooking zones and oven heating elements may be hot even though they are dark in color. Areas near surface cooking zones may become hot enough to cause burns. During and after use, do not touch, or let clothing or other flammable materials touch these areas until they have had sufficient time to cool. Among these areas are the cook top, surfaces facing the cook top, the oven vent openings and surfaces near these openings, oven door and window.

- **Wear proper apparel—Loose-fitting or hanging garments should never be worn while using the appliance.** Do not let clothing or other flammable materials contact hot surfaces.
- **Do not use water or flour on grease fires—Smother the fire with a pan lid, or use baking soda, a dry chemical or foam-type extinguisher.**
- **When heating fat or grease, watch it closely.** Fat or grease may catch fire if allowed to become too hot.
- **Use only dry potholders - Moist or damp potholders on hot surfaces may result in burns from steam.** Do not let potholders touch hot heating elements. Do not use a towel or other bulky cloth instead of a potholder.
- **Do not heat unopened food containers - Buildup of pressure may cause container to burst and result in injury.**

IMPORTANT

The appliance will not operate during a power failure. Once the power resumes, you must reset the time of day before using the oven.

Important instructions for using your cooktop

- **Know which control operates each surface cooking zone.** Place a pan of food on the unit before turning it on, and turn the zone off before removing the pan.
 - **Use proper pan size—**This appliance is equipped with one or more surface cooking zones of different sizes. Select utensils having flat bottoms large enough to cover the cooking zone. Proper relationship of utensil to heating zone will also improve efficiency.
 - **Utensil handles should be turned inward and not extend over adjacent cooking zones—**To reduce the risk of burns, ignition of flammable materials, and spillage due to unintentional contact with the utensil, the handle of the utensil should be positioned so that it is turned inward, and does not extend over adjacent cooking zones.
 - **Never leave surface cooking zones unattended at high heat settings—**Boilovers cause smoking and greasy spillovers that may ignite, or a pan that has boiled dry may melt.
-

Important safety instructions

- **Glazed cooking utensils**—Only certain types of glass, glass/ceramic, ceramic, earthenware, or other glazed utensils are suitable for cook top service without breaking due to the sudden change in temperature. Check the manufacturer's recommendations for cook top use.
- **When flaming foods under a ventilating hood, turn the fan on.**

For ceramic-glass cook top models

- **Do not cook on broken cook top**—If cook top should break, cleaning solutions and spillovers may penetrate the broken cook top and create a risk of electric shock. Contact a qualified technician immediately.
- **Clean cook top with caution**—If a wet sponge or cloth is used to wipe spills on a hot cooking area, be careful to avoid a steam burn. Some cleaners can produce noxious fumes if applied to a hot surface.

Important instructions for using your oven

- **Use care when opening oven door or lower oven drawer (if equipped)**—Stand to the side of the range when opening the door of a hot oven. Let hot air or steam escape before you remove or replace food in the oven.
- **Keep oven vent ducts unobstructed.** The oven vent is located below the backguard for models equipped with ceramic-glass cook tops. Touching the surfaces in this area when the oven is operating may cause severe burns. Also, do not place plastic or heat-sensitive items on or near the oven vent. These items could melt or ignite.
- **Placement of oven racks.** Always place oven racks in desired location while oven is cool. If rack must be moved while oven is hot use extreme caution. Use potholders and grasp the rack with both hands to reposition. Do not let potholders contact the hot heating elements in the oven. Remove all utensils from the rack before moving.
- **Do not use the broiler pan without its insert.** The broiler pan and its insert allow dripping fat to drain and be kept away from the high heat of the broiler.
- **Do not cover the broiler insert with aluminum foil. Exposed fat and grease could ignite.**
- **Cold temperatures** can damage the electronic control. When using the appliance for the first time, or when the appliance has not been used for an extended period of time, be certain the unit has been in temperatures above 32°F (0°C) for at least 3 hours before turning on the power to the appliance.

Important instructions for cleaning your range

- **Clean the range regularly to keep all parts free of grease that could catch fire.** Pay particular attention to the area underneath each surface element. Do not allow grease to accumulate.
- **Kitchen cleaners and aerosols—Always follow the manufacturer's recommended directions for use.** Be aware that excess residue from cleaners and aerosols may ignite causing damage and injury.
- **Clean ventilating hoods frequently—Grease should not be allowed to accumulate on the hood or filter.** Follow manufacturer's instructions for cleaning.

Self cleaning ovens

- **Clean in the self-cleaning cycle only the parts listed in this Use & Care Manual.** Before self cleaning the oven, remove the oven racks, broiler pan, broiler pan insert and any utensils or foods from the oven.
- **Do not use oven cleaners**—No commercial oven cleaner or oven liner protective coating of any kind should be used in or around any part of the oven.
- **Do not clean door gasket**—The door gasket is essential for a good seal. Care should be taken not to rub, damage or move the gasket.
- The health of some birds is extremely sensitive to the fumes given off during the self-cleaning cycle of any range. Move birds to another well-ventilated room.

Important safety notice

The California Safe Drinking Water and Toxic Enforcement Act requires the Governor of California to publish a list of substances known to the state to cause cancer, birth defects or other reproductive harm, and requires businesses to warn customers of potential exposure to such substances.

6 Features

Wave-Touch™ oven features & options

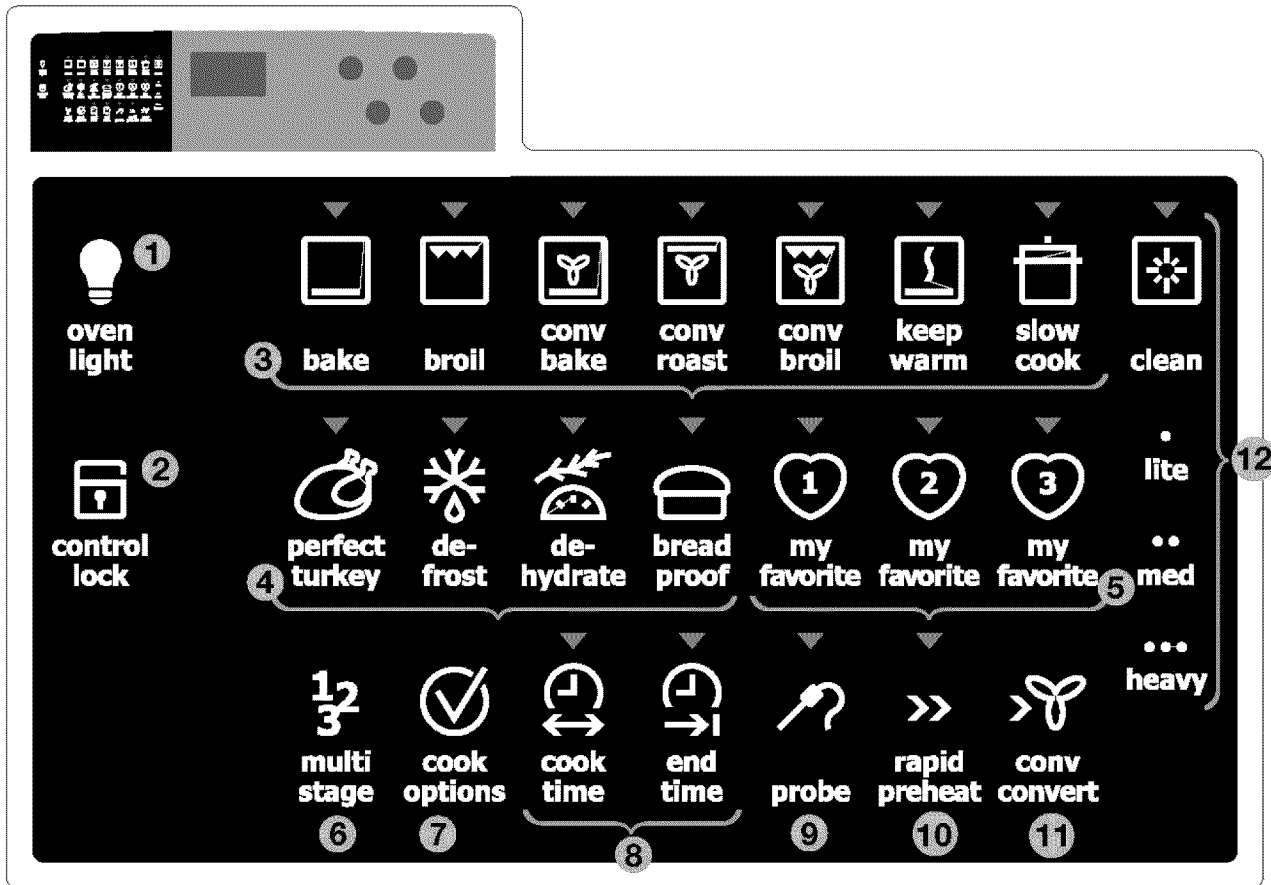

1. Luxury-Lighting™ interior oven lights -pg 11-
2. Control lock -pg 11-
3. Standard cooking
 - Bake -pg 21-
 - Broil -pg 24-
 - Perfect-Convect³™ convection bake -pg 26-
 - Perfect-Convect³™ convection roast -pg 28-
 - Perfect-Convect³™ convection broil -pg -32-
 - Keep warm -pg 33-
 - Slow cook -pg 34-
4. Specialized cooking
 - Perfect Turkey™ -pg 35-
 - Defrost -pg 36-
 - Dehydrate - pg 36-
 - Bread proof -pg 37-
5. Favorite settings -pg 38-
6. Perfect Program™ multi stage cooking -pg 39-
7. Cook options
8. Cooking time
 - Cook time -pg 22-
 - End time -pg 23-
9. Probe -pg 30-31-

10. Rapid preheat -pg 20-
11. Convection convert -pg 27-
12. Cleaning -pg 52-53-

Minimum & maximum control settings		
Feature	Min. temp	Max. temp
Bake (upper)	170°F / 76°C	500°F / 260°C
Bake (lower)	170°F / 76°C	450°F / 232°C
Bread Proof	Lo (85°F / 30°C)	Hi (100°F / 38°C)
Broil	300°F / 148°C	550°F / 288°C
Conv Bake	170°F / 76°C	500°F / 260°C
Conv Roast	170°F / 76°C	500°F / 260°C
Conv Broil	300°F / 148°C	550°F / 288°C
Keep Warm	150°F / 66°C	190°F / 88°C
Slow Cook	Lo (225°F / 108°C)	Hi (275°F / 135°C)
Dehydrate	100°F / 38°C	225°F / 108°C
Perfect Turkey	300°F / 148°C	500°F / 260°C

Wave-Touch™ oven control display & keys

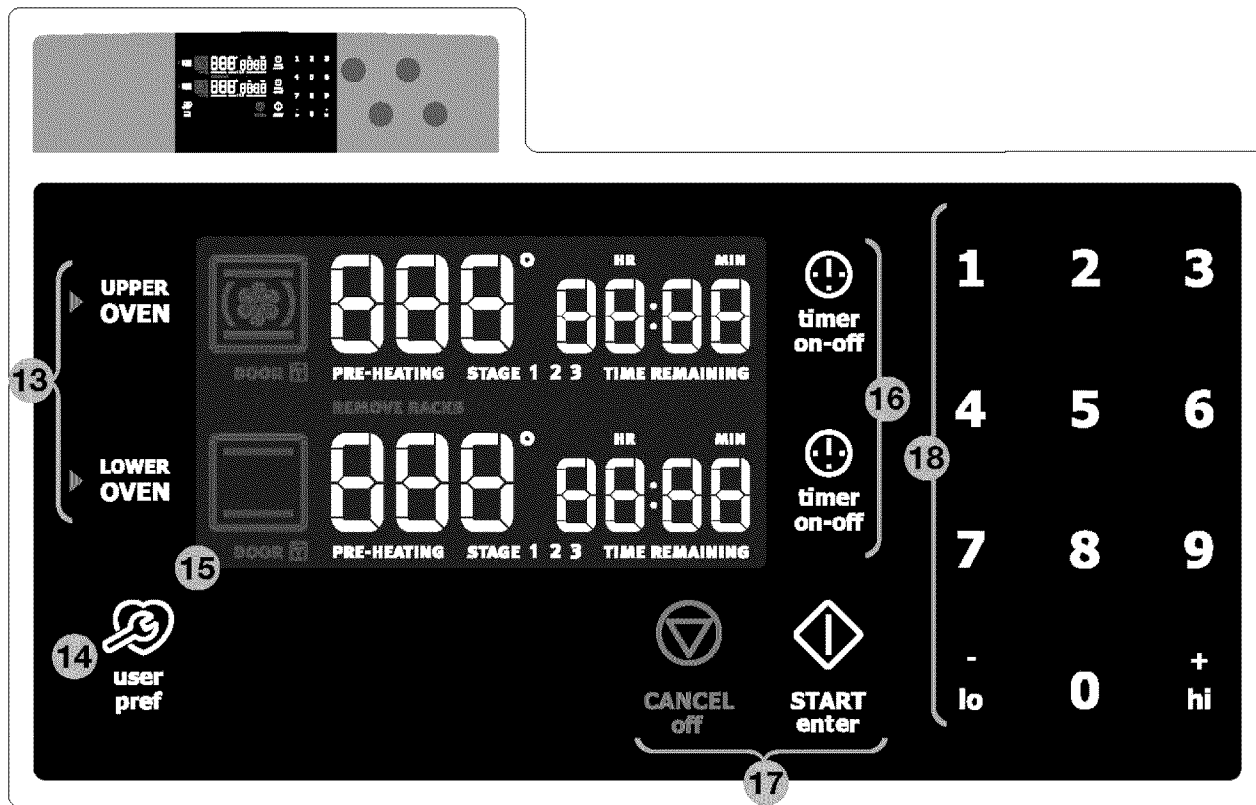

13. Perfect-Pair™ oven key pads

- Sure-2-fit™ Upper oven
- Lower oven

14. User preferences -pg 46-51-

The following options are available under User Preferences:

- Clock setting -pg 10 & 46-
- Clock display setting -pg 46-
- 12 hr/24 hr -pg 47-
- Fahrenheit / Celsius -pg 47-
- 12 Hr energy save mode on/off -pg 48-
- Audio mode -pg 48-
- UPO offset (temp. adjust) or reset -pg 49-
- Factory default reset -pg 50-

15. Oven display

16. Timers -pg 10-

17. Cancel & Start key pads

18. Numeric key pads

Minimum & maximum time settings

Feature	Min. time	Max. time
Timer 1	1 min	11 hr 59 min
Timer 2	1 min	11 hr 59 min
Clock 12 hr	1:00 hr	11 hr 59 min
Clock 24 hr	0:00 hr	23 hr 59 min
Cook time 12 hr	1 min	11 hr 59 min
Cook time 24 hr	1 min	23 hr 59 min
End time 12 hr	1:00 hr	12 hr 59 min
End time 24 hr	0:00 hr	23 hr 59 min
Clean duration	Light (2 hr)	Heavy (4 hr)

8 Features

Wave-Touch™ Induction cooktop and control display



Cooktop controls - pg 15-18 -

19. Left rear 7 in. Induction cooking zone and control

20. Right rear 6 in. Induction cooking zone and control

21. Left front 8 in. Induction cooking zone and control

22. Right front 10 in. Induction cooking zone and control

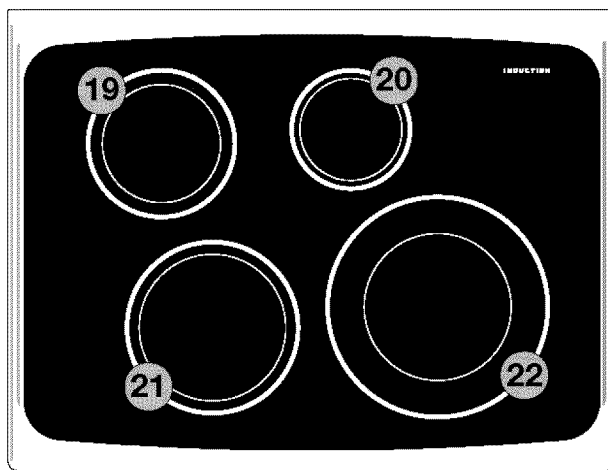

Wave-Touch™ range features

Your electric range features include:

1. Wave-Touch™ activated glass control panel.
2. Wave-Touch™ electronic oven & surface controls & timers.
3. Sure-2-fit™ cobalt blue self-cleaning upper oven interior.
4. Self-clean oven door latch.
5. Automatic interior oven door light switch.
6. Theatre style upper oven interior halogen Luxury-Lighting™ system.
7. Perfect-Convect³™ convection fan system.
8. fully extendable Luxury-Glide™ telescoping interior oven rack.
9. 1 flat /1offset interior oven rack (not shown).
10. Oven rack sensor.
11. Large 1-piece metal upper & lower oven door handles.
12. Color coordinated or stainless steel oven exterior panels & trim.
13. Full-width tinted oven door window glass.
14. Perfect-Pair™ lower oven.
15. Lower oven door window glass.
16. Easy to clean upswept color coordinated or stainless steel cooktop.
17. Ceramic smoothtop (not shown)
18. Leveling legs & anti-tip bracket (included).
19. Broiler pan.
20. Broiler pan insert.
21. Convection roasting rack
22. Lower oven rack.

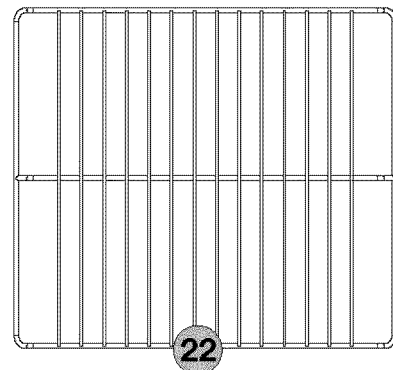
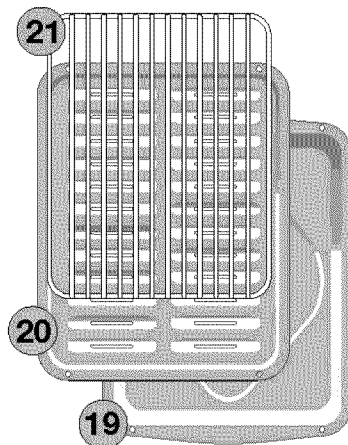
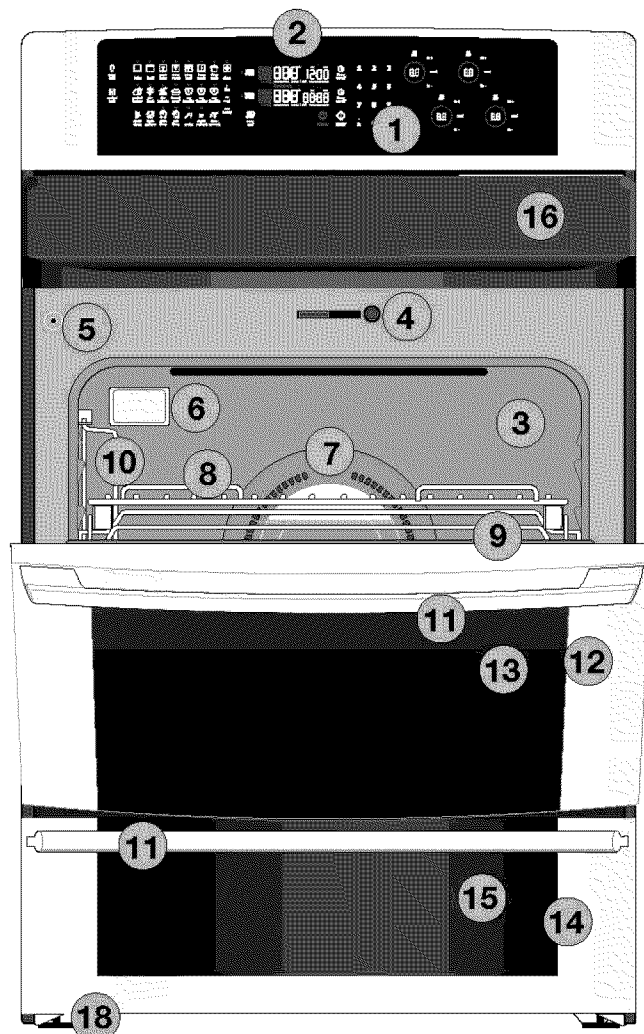

10 Getting Started

Setting clock at power up

You will be prompted to enter the time of day in the event of a **power failure** or when you **first provide electric power** to your appliance.

- When your appliance is first powered up, 12:00 will flash in the display.
- Enter the time of day using the numeric key pads and press **START** to set.

If an invalid time of day is entered, the control will triple beep. Re-enter a valid time of day and press **START**. If **CANCEL** is pressed your clock will start with the time set for **12:00**.

Select the user pref key to modify the time of day during other situations such as day light savings.

Wave-Touch™ display modes

Sleep mode

Your control will remain in a sleep mode -Fig.1- when not in use, unless there is a hot element. Only the clock will display during this mode. You will need to wake the control to begin any function.

Awake mode

To awake the control -Fig. 2- touch within the display panel. If the control panel is not touched again within 2 minutes, the control will return to the sleep mode. To start cooking you must select either the upper oven, lower oven, or a surface element. User preferences will be available during this mode as well as timers, oven light and the control lock.



Timers

The two timers provided with the oven control serve as extra reminders in the kitchen. When a timer reaches less than 1 minute the display will start to count down in seconds. When the time runs out the active timer will beep, "00:00" will display and the timer key will flash.

The following time settings apply to the timers:

- Min. time: 1 minute
- Max. time: 11 hours 59 minutes

See example below to set the timer for 5 minutes:

Example	
Step	Press
1. Press TIMER	
2. Enter 5 minutes	5
3. Press TIMER	

To cancel after setting the timer, press the **TIMER** key again.

NOTE

The timer will not affect the cooking process.



Sleep mode

Fig.1



Awake mode

Fig.2

Changing settings

Software controls the upper and lower ovens so that both may be set to operate at the same time with unique settings. It is very important to understand that before setting or modifying either oven, you must first **select** which oven you desire to set or modify.

The display will provide which oven is currently **selected** for setting/changes by displaying a small red triangle indicator next to the upper or lower oven text -Fig.1.

If the upper oven text symbol displays the red triangle indicator but you wish to set or change the settings for the lower oven, press **LOWER OVEN** once to change the oven selection. Then make the setting/changes. You may toggle between either oven and make setting changes at any time. You may also make cooktop settings or modifications without having to make an oven selection.

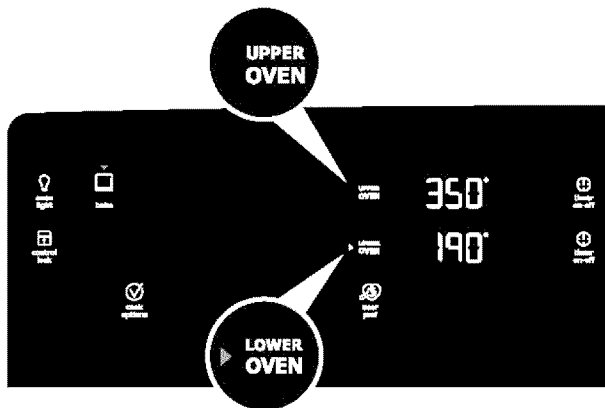

Fig.1

Preheat Temperature Display

Once a cooking feature has been started for either the upper or lower oven the control will display the actual oven temperature while preheating. Once the oven reaches the oven set temperature only the oven set temperature will display.

Control lock

The control lock will lock the oven controls, cook top controls and the upper oven door. Once locked, the upper oven light will not switch from on to off or off to on.

Control lock is available only in the awake mode.

See example below to lock the upper oven and the cooktop

Example	
Step	Press
To lock, press and hold CONTROL LOCK for 3 seconds.	
To unlock, press and hold CONTROL LOCK for 3 seconds.	

DOOR  will flash in the display until the door has finished locking. Once the door has been locked the door lock indicator will turn on. LOC will then display in the upper oven cavity only.

Do not attempt to open the oven door while the door lock indicator is flashing.

If an element is still hot when control lock is in use "HE" will appear in the control panel.

Interior Luxury-Lighting™

Your appliance includes interior oven Luxury-Lighting™ that gradually brightens and dims the lights for both the upper and lower ovens.

The  key controls the interior oven lights.

This model includes 2 halogen lights in the upper oven and one standard appliance light located on the rear wall of the lower oven.

The oven lights will automatically turn ON whenever the upper oven door is opened. The lights will remain on until the door has been shut.

To replace any of the interior light bulbs see "Changing the oven lights" in the Care and Cleaning section.

12 Setting for Best Results

Upper oven racks

Types of oven racks

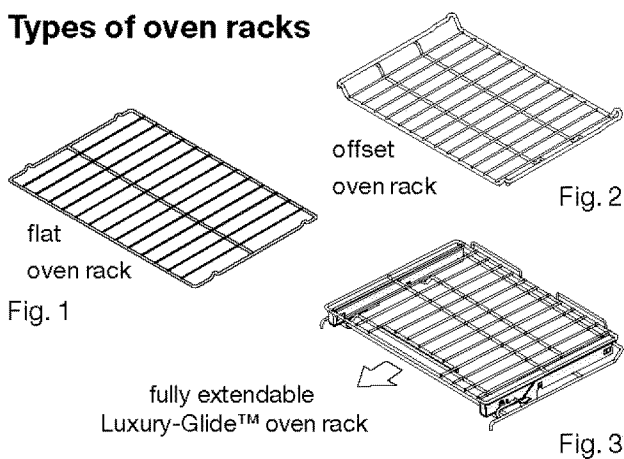

Fig. 1

Fig. 2

Fig. 3

CAUTION

Always use potholders or oven mitts when removing food or adjusting the oven racks. Wait until the oven has completely cooled if possible. Oven racks may be **HOT** and may cause burns.

The **flat** oven rack -Fig 1- may be used in all rack positions and may be used for most cooking needs.

The **offset** -Fig 2- oven rack design provides additional height choices and may be used in all rack positions. For maximum available space when preparing a large turkey, it is suggested to place rack near the oven bottom (rack positions 1 or 2) - refer to Fig. 4-. Do not extend offset rack past the oven door when used in the lowest rack position.

The fully extendable **Luxury-Glide™** oven rack -Fig. 3- makes food preparation easier, especially when preparing heavier dishes. The rack is designed with bearing glide tracks that allow you to extend the food away from the oven cavity effortlessly.

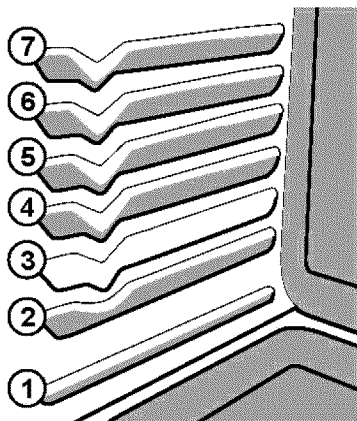

Fig. 4

Baking layer cakes with 1 or 2 oven racks

For best results when baking cakes using two oven racks, place cookware using oven rack positions 2 & 5 -refer to Fig. 4-. For best results when baking cakes using the offset oven rack alone, place cookware using oven rack position 2 or 3.

Air circulation in the oven

For best air circulation and baking results allow a space of 2-4" (5-10 cm) around the cookware for proper air circulation and be sure cookware does not touch each other, the oven door, sides or back of oven cavity. The hot air must be able to circulate around the cookware in the oven for even heat to reach around the food -refer to Figs. 5 & 6-.



Fig. 5 - Proper pan spacing using single oven rack.



Fig. 6 - Proper pan spacing using 2 oven racks.

Upper oven racks (cont'd)

CAUTION

Always use potholders or oven mitts when removing food or adjusting the oven racks. Wait until the oven has completely cooled if possible. Oven racks may be **HOT** and may cause burns.

NOTE

DO NOT attempt to close the oven door until all the oven racks are positioned completely inside the oven cavity. Be sure the glide oven racks make contact with the vertical rack sensor located at the left rear oven cavity wall (see item #10, page 9).

Removing and replacing the Luxury-Glide™ oven rack

To remove using one hand, reach through handle opening on top of glide rack and lift up on the release lever located across the lower front of the rack as shown -Fig. 1-.

While holding up on the release lever, pull the glide rack out of the oven until you reach the oven rack stop position -Fig. 2-. Using both hands, grasp the upper and lower portions of the glide rack. Lift up the front of the rack slightly and continue to pull the rack away from the oven -Fig. 3-. Be sure to grasp both upper and lower rack portions together when removing or handling the glide rack - the rack portions move independently and are difficult to handle unless held together.

To replace - grasp **both upper and lower portions** of glide rack, lift and place the rack resting evenly between the oven cavity walls. Tilt the front of the rack upward slightly and slide the rack completely into position. Some force may be necessary to make sure the oven rack has snapped completely back into place.

Removing and replacing flat and offset oven racks

- **To remove** pull the oven rack straight forward until it reaches the stop position. Lift up front of oven rack slightly and slide out (not shown).
- **To replace**, fit the oven rack onto the rack guides on the oven walls. Tilt the front of the rack upward slightly and slide the oven rack completely back into place (not shown).

Luxury-Glide™ extendable oven rack

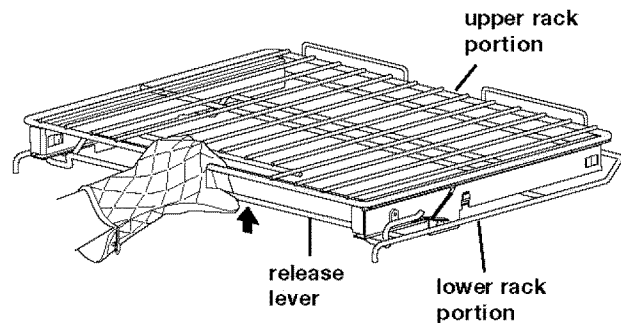

Fig. 1

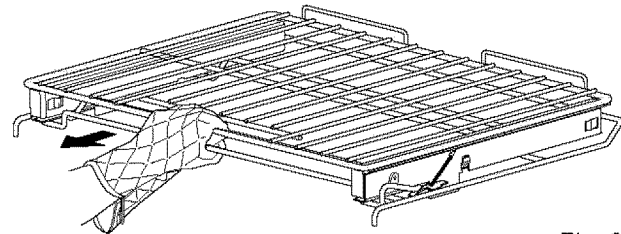

Fig. 2

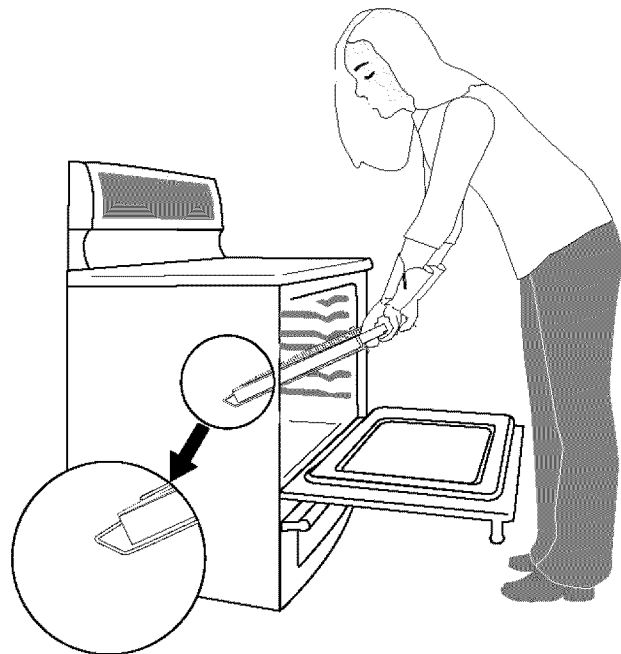

Fig. 3

14 Induction Cooking

Induction Cookware

Induction cookware types

When purchasing cookware for use on the cooktop, look for utensils specifically identified by the manufacturer as **induction ready**, **induction capable**, or a similar statement by the manufacturer that the cookware is constructed for induction cooking. Be sure to follow all the manufacturer's recommendations when using cookware made for induction cooking.

If you're not sure, use a magnet to test whether the pan material type will work. If a magnet sticks to the bottom of the cookware, the material type is correct for induction (See Fig. 1).

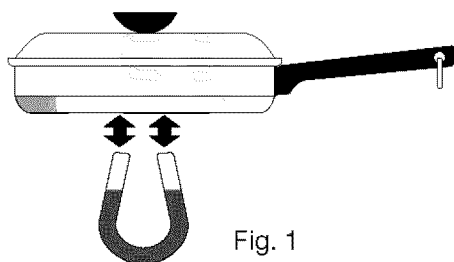

Fig. 1

The most common induction cookware types available:

Stainless steel - Generally, excellent for induction cooking. Is durable, easy to clean and resists staining.

Cast iron - Good for induction cooking. Cooks evenly. Do not slide cast iron cookware on cooktop. Cast iron cookware with rough surface will scratch ceramic cooktop.

Porcelain enamel on ferrous metal - Heating characteristics will vary depending on base material. Porcelain-enamel coating must be smooth to avoid scratching ceramic cooktop.

NOTES

- Not all stainless steel cookware is readily magnetizable; being made of stainless steel does not mean that cookware is suitable for induction.
- Aluminum, copper, glass or non-ferrous metal cookware that is not made for induction cooking will not be detected by the cooking zone sensors and will not heat.

Pan Sensing

Cooking zone sensors

➔ IMPORTANT

A number of incorrect cookware conditions may be detected by sensors located below the cooktop. If the cookware does not meet the correct conditions, one or more of the cooking zones may not heat. Correct the problems before attempting to activate cooking zone.

Review the list of conditions below:

Correct

- Cookware base material has good magnetic characteristics.

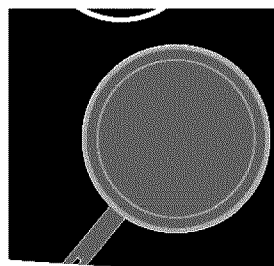

- Cookware centered on cooking zone.



- Flat pan bottom and straight sides.

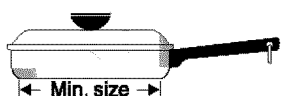

- Pan size meets or exceeds the recommended minimum size for cooking zone.



- Pan rests completely on the cooktop surface.



- Pan is properly balanced.

Incorrect

- Cookware base material is non-magnetic.

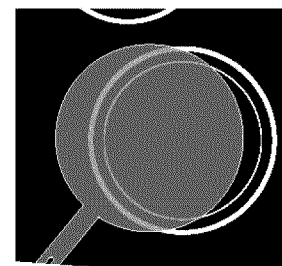

- Cookware not centered on cooking zone.



- Curved or warped pan bottoms or sides.

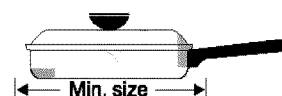

- Pan does not meet the minimum size required (too small) for cooking zone used.



- Pan bottom rests on cooktop trim.

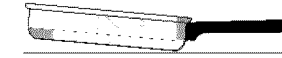

- Heavy handle tilts pan.

Pan Sensing (cont'd)

Only use quality cookware in good condition

It is recommended to always use high quality cookware with heavier bottoms. This will provide better heat distribution and give better cooking results. Cookware must have flat bottoms that make good contact with the entire induction cooking zone surface. Check for flatness by rotating a ruler across the bottom of the cookware.

When using your Induction cooktop:

- The pan size **must** closely fit the pattern on the cooktop and should match the amount of food being prepared.
- Use clean cookware only. Do not use dirty pans with grease buildup on the cooktop.
- Do not let pans boil dry. This may cause **permanent damage** in the form of breakage, fusion, or marring that can affect the ceramic cooktop. (This type of damage is not covered by your warranty).

Minimum and maximum cookware sizes

All four cooking zones on induction cooktop require a **minimum** pan size to be used at each location.

If a pan is **too small**, the red heating ring will not appear in the cooking zone display, indicating a possible problem with the pan size (Fig. 1). A pan that is too small will not heat. When the cooking zone is ready to heat, the red heating indicator will display for the cooking zone (Fig. 2).



Fig. 1

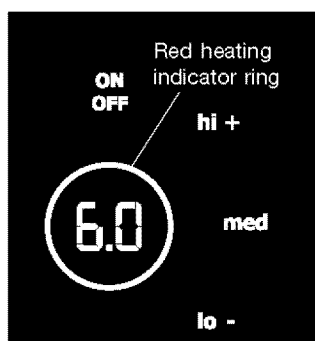

Fig. 2

The smaller inner ring marked on the cooktop for each cooking zone is your guide for the correct **minimum** pan size to use (See Fig. 3). The pan bottom must **fully cover** the inside ring for heating to occur.

Minimum pan size requirement for cooking zones

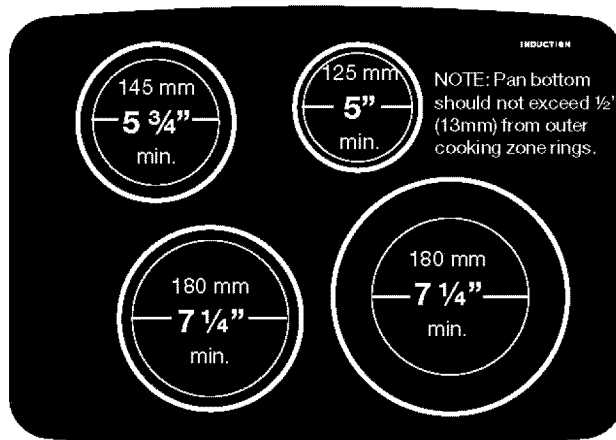

Fig. 3

The thicker outer ring marked at each cooking zone (Fig. 3) is helpful to determine the **maximum** pan size recommended for use on each cooking zone. After centering the cookware on a cooking zone, be sure cookware does not extend more than 1/2" (13mm) beyond the outer line. The pan must make **FULL** contact on the glass surface without the bottom of the pan touching the metal cooktop edges.

➔ IMPORTANT

Correct any problems before attempting to activate the cooking zone. Once the problems have been corrected the red heating ring will show in the cooking zone display (Fig. 2).

16 Setting Induction Controls

Before Operating the Induction Cooktop

The Induction cooktop control provides 4 digital display windows to help when setting power levels for each of the cooking zones (Fig. 1). These settings are shown using LED style displays.

NOTE

- Unlike standard ceramic cooktops, Induction cooking zones do not heat and will not glow red when active. Only the pan heats. Also, Induction cooking zones cannot be turned ON without a properly placed pan made of magnetic material such as steel or cast iron. This feature helps reduce accidental turn-ons.

Cooking Zone ON/OFF

Each cooking zone display window has an **ON OFF** activation key. Touch the corresponding cooking zone **ON OFF** key once to activate the cooking zone needed. When a cooking zone is activated, **0.0** (Fig. 2) will appear in the display window. If any of the corresponding **hi +**, **med**, or **lo -** power level keys are not touched within 5 seconds, the request to activate the cooking zone will cancel.

To turn OFF an active cooking zone, touch the corresponding cooking zone **ON OFF** key once.

Induction Power Level Settings

Once activated each cooking zone will provide 23 power levels to choose from. These include **Lo** (Fig. 3), **1.2, 1.4, 1.6, 1.8, 2.0, 2.2, 2.4, 2.6, 2.8, 3.0, 3.5, 4.0, 4.5, 5.0** (Fig. 4), **5.5, 6.0, 6.5, 7.0, 8.0, 9.0, Hi** (Fig. 5) and **Pb** (See Fig. 6).

The highest setting of **Pb (Power Boost)** provides the maximum power level for up to 10 minutes (See Fig. 6). After 10 minutes, the cooking zone will automatically lower to the **Hi** setting. The Power Boost setting is only available immediately after activating a cooking zone and by pressing **hi+**.

If **Pb** is active, but the **Hi** setting is preferred over **Pb**, touch the **lo-** key once to adjust down to the **Hi** setting.

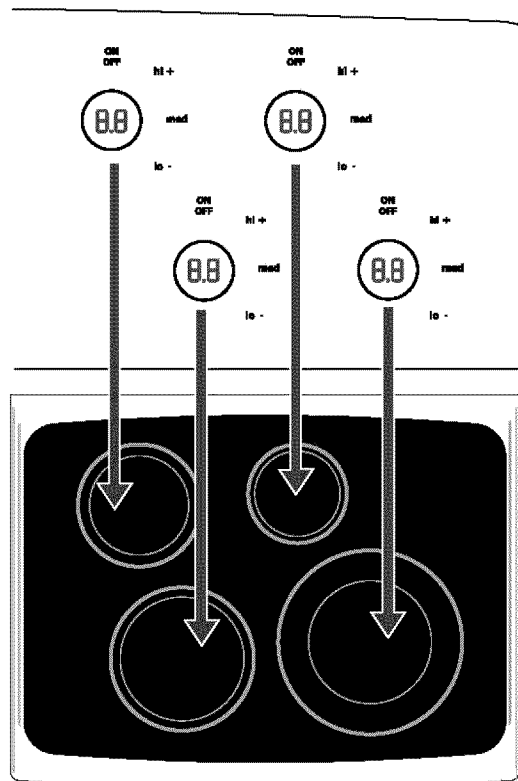

Fig. 1

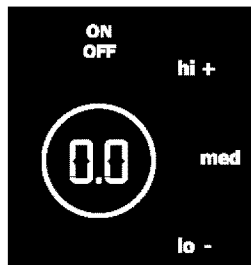

Fig. 2

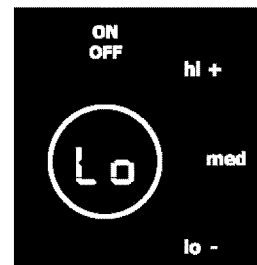

Fig. 3



Fig. 4

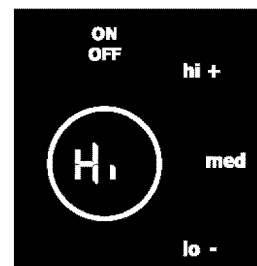

Fig. 5

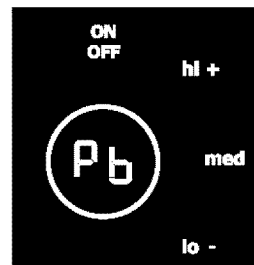

Fig. 6

Before Operating the Induction Cooktop (cont'd)

Incremental Power Level Changes

The **hi+** and **lo-** keys provide incremental adjustments for more precise control when changing settings between the lower heat levels (Lo to 3.0 power levels). Higher heat level setting changes (between 7.0 to Hi) will change much faster (Fig. 1).

Display Settings Changes	
Setting	Incremental change
Lo to 3.0	0.2
3.0 to 7.0	0.5
7.0 to Hi	1.0

Fig. 1

Induction Power Level Settings

Use the following chart (Fig. 2) to help determine the suggested Induction power level setting for the type of food you are preparing:

Suggested Induction Power Level Settings	
Setting	Type of cooking
Power Boost (Pb)	Use when first starting to heat pans that contain large amounts of food or to bring large pans of water to boil.
High (8-Hi)	Start most foods, bring water to boil, pan broiling.
Medium high (5-8)	Continue a rapid boil, fry, deep fat fry.
Medium (3-5)	Maintain a slow boil, thicken sauces and gravies, steam vegetables.
Medium low (2-3)	Keep foods cooking, poach, stew.
Lo (Lo-2)	Keep warm, melt, simmer.

Fig. 2

(HE) Hot Surface Message

CAUTION

- The cooking zones may **appear to be cool** while turned ON and after they have been turned OFF. The Induction cooking zones will not turn red when they are on. The ceramic glass surface **may be HOT** from **residual heat transferred from the cookware** and burns may occur.

After powering ON any of the cooking zone positions the cooktop ceramic surface MAY become hot from residual heat transferred from the cookware and burns may occur. After turning any of these cooking zones OFF, the cooktop may remain **HOT** for some time.

The cooktop control monitors the temperature of the cooktop surface and will display the message “HE” Hot Element (See Fig. 3) and flash the red ring whenever one of the cooking zones becomes too HOT to touch. The “HE” indicator light will remain ON while hot and turn OFF once the cooktop has cooled sufficiently.

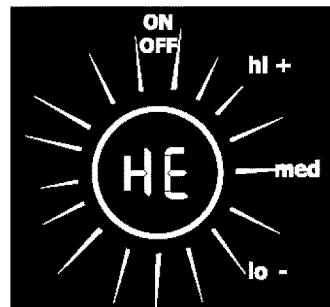

Fig. 3

NOTE

When the **HE** cooktop message is displayed, the cooking zone may still be activated again and used for cooking.

18 Setting Induction Controls

Setting the Wave-Touch™ Induction cooktop

Preheating Recommendations

Induction cooking may decrease the amount of time normally required to preheat a cooking utensil when compared to cooking with a radiant element cooktop or gas surface burner. Whenever using the cooktop or oven, always pay close attention to all food items cooking and remain very attentive until the cooking processes are complete.

Setting cooktop cooking zones

Be sure to use cookware that meets the correct conditions for the cooking zone desired (See pages 14 & 15). Place the cookware with the prepared food on the cooking zone before setting the cooktop control.

To turn ON one or more of the cooking zones:

1. If needed, wake the control panel.
2. Place the prepared food using the correct type and size cookware on the desired cooking zone. Be sure to center the cookware on the cooking zone completely covering the minimum ring marked on the zone surface.
3. Touch the **ON OFF** key for the desired cooking zone. A beep will sound, the chosen cooking zone display will show a red heating ring and the power level will show “**0.0**”, indicating the zone is ready. If no other key is touched within 5 seconds, the request to power ON the cooking zone will clear.
4. Set the desired power level for the cooking zone by touching the **hi +**, **med** (power level 5.0) or **lo -** key. If the **hi +** key is touched once, the cooking zone will start at a **Pb** (Power Boost) maximum power level. If the **lo -** key is touched once the cooking zone will start at the lowest setting available.

To turn OFF the cooking zones:

1. Once cooking is complete, touch the **ON OFF** key to turn the cooking zone OFF.
2. When any cooking zone is OFF, the hot surface (HE) message indicator may turn on if the cooking zone temperature is HOT. The hot surface (HE) message will remain ON as long as the cooktop remains hot.

CAUTION

- **DO NOT TOUCH HOT COOKWARE or PANS directly with hands.** Always use oven mitts or pot holders to protect hands from burns.
- The cooking zones may appear to be cool when heating and after they have been turned OFF. The induction cooking zones will not turn red when they are on. **The glass surface may be HOT** from residual heat transferred from the cookware and burns may occur.

IMPORTANT

If the **cookware is moved** from the center of any **active cooking zone**, a sensor will detect the situation and the cookware **will no longer heat**. The affected cooking zone display window will show **no red heating ring** indicating the need to center the cookware. The cooking zone will remember the power level setting for up to 3 minutes before the cooking zone will automatically shut OFF. If the cookware is brought back properly centered over the cooking zone again, the red heating ring in the display will turn back on. The affected cooking zone will resume heating and will remember the original power level setting.

NOTES

- If the **Hi** power level is desired instead of **Pb** (Power Boost) when activating a cooking zone, press the **hi+** key once then press **lo-** key to reduce from Pb to Hi.
 - Use the **hi+** or **lo-** keys to adjust or scroll through power levels at any time during the cooking process. To quickly scroll through the power levels, touch and hold the **hi+** or **lo-** key until the power level desired is reached. Once the cooking zone power level has been set, the food will begin to heat at that level until the power level is manually changed.
-

Induction Power Sharing

How Power Sharing works

Your cooktop is equipped with four induction cooking zones within two heating zone sections. The right-hand and left-hand cooking zone sections (See Fig. 1) are powered by two independent induction inverters - one inverter for each of the two heating sections. Two cooking zones in a heating section share the power of the same inverter. This is called “Power Sharing”.

If pans are cooking food items on both right-hand cooking zones, the **last** power level set will be **maintained**, while the first pan may experience a reduction in the power level setting.

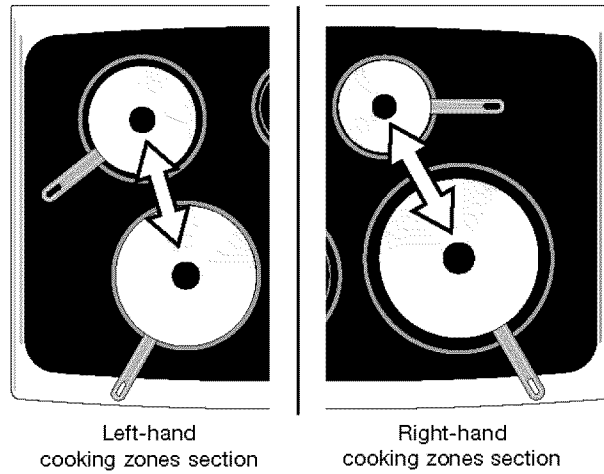

Fig. 1



For best results

Power Sharing Tip:

To help avoid power sharing, you may choose to maintain a constant power level for 2 food items at the same time by placing the pans on one of the left-hand zones and the other pan on one of the right-hand zones. See the example of pan placement in Fig. 2.

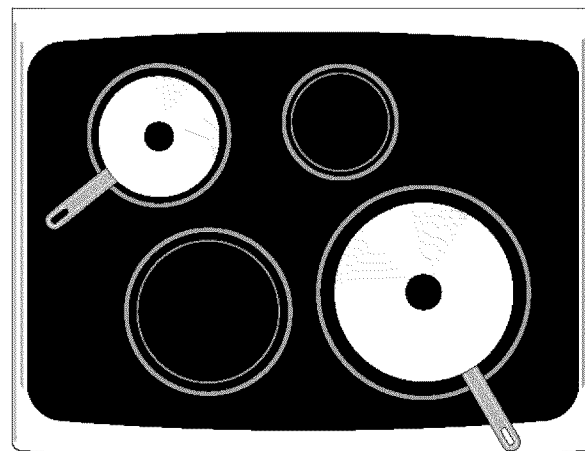

Fig. 2

Operational Noises

The electronic processes involved with Induction cooking may create some unusual background noises. You may hear a slight “buzz” sound when cooking. These noises are normal and are a part of the Induction cooking process. Some cookware will “buzz” louder depending on the material. The “buzz” sound may be more noticeable if the contents of the pan are cold; as the pan heats up, the sound will decrease. If the power setting is reduced, the sound level will also decrease.

Please note that these noises are more noticeable while cooking at the “Pb” level. Very loud noises are **not** part of normal Induction cooking.

Oven Vent Location

The oven vent is located under the left side of the control panel. When the upper oven is operational, warm air will pass through this vent naturally. The venting is necessary for proper air circulation and provides good baking results in the upper oven. **do not** place items **on the cooktop** that will block this area.

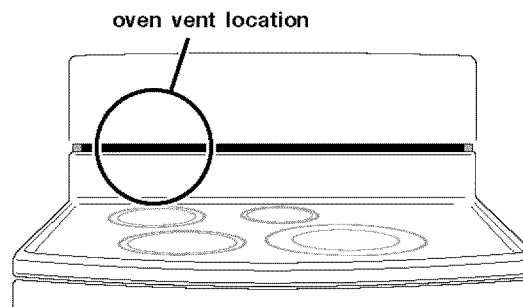

20 Setting Oven Controls

About rapid preheat

Use the rapid preheat option on **single rack baking** to quickly bring the upper oven to baking temperature.

The rapid preheat option may be set with the following cooking features:





- Bake
- Conv bake
- Conv roast

The following temperature settings apply to the rapid preheat feature:

- Auto-suggest (default) setting: **350°F / 176°C**
- Min. rapid preheat setting: **170°F / 76°C**
- Max. rapid preheat setting: **500°F / 260°C**

Setting rapid preheat

See example below to set a rapid preheat with bake to start immediately using default temperature.

Example	
Step	Press
1. Press UPPER OVEN	
2. Press BAKE	
3. Press COOK OPTIONS	
4. Press RAPID PREHEAT	
5. Press START/enter	

When **START** is pressed the oven will preheat quickly. The control will display **PRE-HEATING** during this time. While **PREHEATING** the Convection fan may operate.

After a few minutes a beep will sound and **PRE-HEATING** will no longer display. Place prepared food on a single oven rack. The oven will continue to bake at the set temperature until bake is canceled.

NOTE

You may press **CANCEL** at any time when setting the control or during the cooking process.

To add or change any cook settings after this feature has started:

- Wake control panel from the sleep mode if necessary.
- Select the **UPPER** or **LOWER** oven you wish to change. Make temperature changes using the **+** or **-** keys. Each press of **+** or **-** will adjust the temperature by 5° F (or 2°C).
- If changing cooking times, select the **cook time** or **end time** keys needed to make the changes.



For best results

- **Single oven rack cooking ONLY.**
- Use in oven rack positions 2 or 3.

About baking in upper oven

Use the bake feature to cook most food items that require normal cooking temperatures.

Bake may be set with the following options:



- Rapid preheat
- Cook time
- Cook time with end time
- Probe

The following temperature settings apply to the bake feature:

- Auto-suggest (default) setting: **350°F / 176°C**
- Min. bake setting: **170°F / 77°C**
- Max. bake setting: **500°F / 260°C**

Setting bake for upper oven



See example below to set a bake to start immediately using the default temperature.

Example	
Step	Press
1. Press UPPER OVEN	
2. Press BAKE	
3. Press START/enter	

Once **START** is pressed the oven will begin heating. The oven display shows **PRE-HEATING**. While **PREHEATING** the Convection fan may operate.

After the oven reaches set temperature, **PRE-HEATING** will turn off and a beep will indicate the oven is ready. The oven will continue to maintain this temperature until the cooking feature is canceled.

If your recipe requires a different baking temperature than the auto-suggested (default) temperature (example below shows upper oven temperature set for 425°F/218°C):

Example	
Step	Press
1. Press UPPER OVEN	
2. Press BAKE	
3. Enter 425°F	425
4. Press START/enter	



For best results

- Place food items in rack positions 2 or 5.
- When using the offset oven rack, place in rack position 2 or 3.
- When placing multiple food items in the oven allow 2-4" (5-10cm) of space between the food items for proper air circulation.
- For best results when baking cakes using 2 oven racks, place cookware on rack positions 2 & 5.

NOTE

You may press **CANCEL** any time when setting the control or during the cooking process.

To add or change any cook settings after this feature has started:

- Wake control panel from the sleep mode if necessary.
- Select the **UPPER** or **LOWER** oven you wish to change. Make temperature changes using the **+** or **-** keys. Each press of **+** or **-** will adjust the temperature by 5° F (or 2°C).
- If changing cooking times, select the **cook time** or **end time** keys needed to make the changes.

22 Setting Oven Controls

Using cook time in upper oven

Adding a cook time when baking is beneficial when a recipe requires a specific temperature and period of time to cook. Following the recipe cook time helps insure the best possible results.







Cook time may be set with the following features:

- Bake
- Conv bake
- Conv roast
- Slow cook
- Defrost
- Dehydrate
- Bread proof
- Keep warm

NOTE

- You may press CANCEL any time when setting the control or during the cooking process.

See example below to set the upper oven for bake, starting immediately with preheating to the auto-suggest (default) setting of 350°F (176°C) and then to automatically turn off after 30 minutes:

Example	
Step	Press
	Preheat the oven if necessary
1. Press UPPER OVEN	
2. Press BAKE	
3. Press START	
4. Press COOK OPTIONS	
5. Press COOK TIME	
6. Enter 30 minutes	30
7. Press START/enter	

Once START is pressed the oven will cook and after 30 minutes automatically shut-off.

Using cook time with end time in upper oven

Adding a cook time along with a specific end time gives the same benefits as the cook time option in addition to controlling exactly when the cooking process will begin and end.







Cook time and end time may be set with the following features:

- Bake
- Convection bake
- Convection roast
- Slow cook
- Clean (delayed Clean uses end time only)
- Defrost
- Dehydrate
- Bread proof
- Keep warm

NOTE

- When setting the END TIME option be sure the correct time of day is set.
- You may press CANCEL any time when setting the control or during the cooking process.
- You may also choose to use **COOK TIME** with no **END TIME**. See pg. 22

See example below to set the upper oven with preheating for bake at 375°F (176°C) for 50 minutes and to automatically shut-off at 5:30:

Example	
Step	Press
1. Press UPPER OVEN	
2. Press BAKE	
3. Enter 375°F	375
4. Press COOK OPTIONS	
5. Press COOK TIME	
6. Enter 50 minutes	50
7. Press END TIME	
8. Enter 5:30	530
9. Press START/enter	

Once START is pressed, the oven will calculate the start time at which the oven will begin heating. The oven display shows PRE-HEATING. While PREHEATING the Convection fan may operate.

After the oven reaches set temperature, PRE-HEATING will turn off and a beep will indicate the oven is ready. The oven will continue to maintain this temperature for the selected time or until the cooking feature is canceled.

24 Setting Oven Controls

Broiling in upper oven

Use the broil feature to cook meats that require direct exposure to radiant heat for optimum browning results. This cooking feature is only available in the upper oven.

Use the conv broil feature to cook thicker cuts of meats that require direct exposure to radiant heat and the convection fan for optimum browning results -p.32-

The following temperature settings apply to the broil feature:

- Auto-suggest (default) setting: **550°F / 288°C**
- Min. broil setting: **300°F / 148°C**
- Max. broil setting: **550°F / 288°C**

WARNING

Should an oven fire occur, close the oven door. If the fire continues, throw baking soda on the fire or use a fire extinguisher. **Do not** put water or flour on the fire. Flour may be explosive and water can cause a grease fire to spread and cause personal injury.

CAUTION

- **Do not** use the broiler pan without the insert.
- **Do not** cover the the broil pan/insert with aluminum foil; the exposed grease could ignite.
- To prevent food from contacting the broil element and to prevent grease splattering, **do not** use the roasting rack when broiling.





For best results

- Use the recommended pans and oven rack positions for the type of meat being prepared - p.25 Figs. 3 & 4-.
- For optimum browning results, allow the oven to preheat **5-6 minutes** before placing the food in the oven.

Setting broil

See example below to set broil for the upper oven starting immediately with the auto-suggest (default) setting:

Example	
Step	Press
1. Place the broiler insert on the broiler pan, then place the meat on the insert. Remember to follow all warnings and cautions.	
2. Arrange the interior oven rack to rack position recommendations -p. 25 Figs. 2 & 4-. Be sure to place the prepared food and pan directly under broil element. Leave the oven door open slightly (about 4 inches) in the broil position. -p. 25 Fig. 1-	
3. Press UPPER OVEN	
4. Press BROIL	
5. Press START/enter	

NOTE

You may press CANCEL any time while setting the control or during the broiling process.

To add or change any cook settings after this feature has started:

- Wake control panel from the sleep mode if necessary.
- Select the **UPPER** or **LOWER** oven you wish to change. Make temperature changes using the + or - keys. Each press of + or - will adjust the temperature by 5° F (or 2°C).
- If changing cooking times, select the **cook time** or **end time** keys needed to make the changes.

Setting broil

The broil pan insert (if equipped) contains slots that allows grease from the meat to drain into the broil pan. Place prepared meat on broil pan insert and then place onto broiler pan as shown -Fig. 3-.

Recommended broiling times

Use the broiling table -Fig. 2- for approximate recommended broiling times for the types of meats listed. Increase or decrease broiling times, or move the broiling pan to a different rack position to suit for doneness.

If the food you are broiling is not listed in the table, follow the instructions provided in your recipe and watch the item closely.

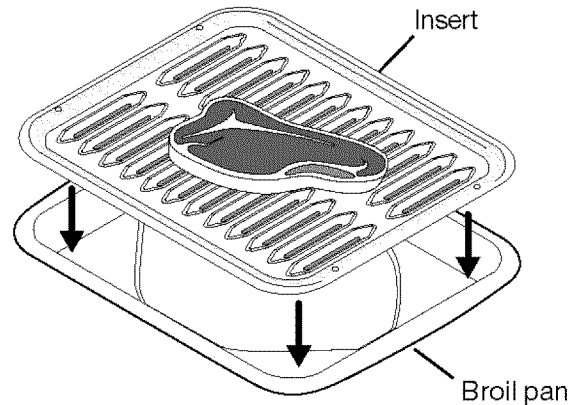
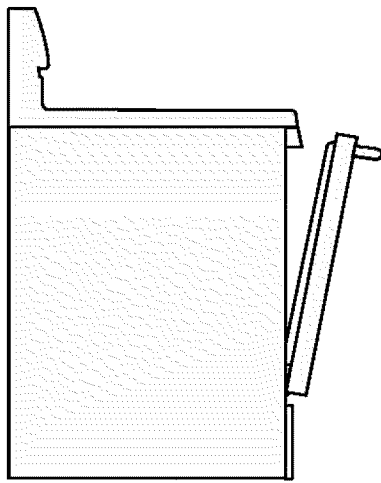

Fig. 3



Broil position
Fig. 1

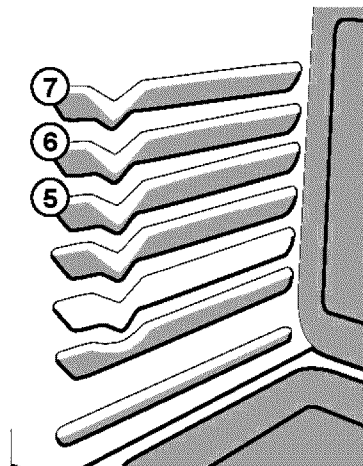

Fig. 4

Broiling Table

Food	Rack position	Temp	Cook time in minutes		Doneness
			1st side	2nd side	
Steak 1" thick	5th or 7th*	550°F	6	4	Medium
Steak 1" thick	6th or 7th*	550°F	7	5	Medium-well
Steak 1" thick	6th or 7th*	550°F	8	7	Well
Pork chops 3/4" thick	6th	550°F	8	6	Well
Chicken-bone in	5th	450°F	20	10	Well
Chicken-boneless	6th	450°F	8	6	Well
Fish	6th	500°F	13	n/a	Well
Shrimp	5th	550°F	5	n/a	Well
Hamburger 1" thick	7th*	550°F	9	7	Medium
Hamburger 1" thick	6th	550°F	10	8	Well

*Use the off-set rack if you choose to use oven rack position 7.

Fig. 2

26 Setting Oven Controls

About convection bake

Convection bake is part of the Perfect-Convect³™ system. Convection bake uses a fan to circulate the oven heat evenly and continuously. The improved heat distribution allows for even cooking with excellent results. Multiple rack cooking may slightly increase cook times for some foods, but the overall result is time saved.

The conv bake feature should **ONLY** be used when your recipe instructions have been written for use with convection baking.

If your recipe instructions are for normal baking and you wish to use convection bake, follow the **Convection Convert** option instructions. The convection convert option will automatically adjust the oven temperature so that convection baking may provide the best possible results.

Conv bake may be set with the following options:

- Conv convert
- Cook time or cook time with end time
- Probe
- Rapid preheat

Benefits of convection bake:

- Superior multiple oven rack performance.
- Some foods cook up to 25 to 30% faster, saving time and energy.
- No special pans or bakeware required.

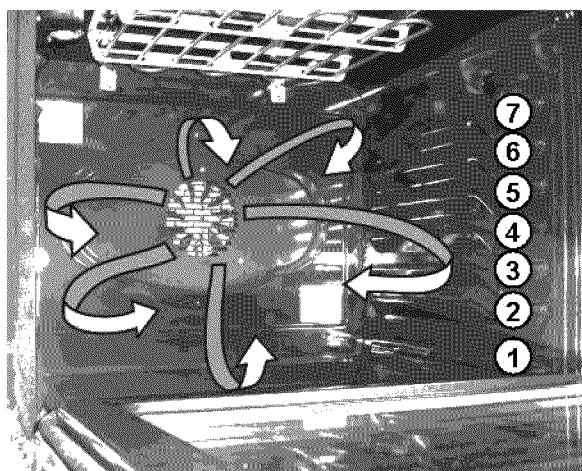

Setting convection bake

The following temperature settings apply to the conv bake feature:

- Auto-suggest (default) setting: **350°F / 176°C**
- Min. bake setting : **170°F / 76°C**
- Max. bake setting: **500°F / 260°C**

See the example below to set conv bake, starting immediately with the auto-suggest (default) setting of 350°F (176°C):

Example	
Step	Press
1. Press UPPER OVEN	UPPER OVEN
2. Press CONV BAKE	
3. Press START/enter	

Once **START** is pressed the oven will begin heating. The oven display shows **PRE-HEATING** during this time.

After the oven reaches set temperature, **PRE-HEATING** will turn off and a beep will indicate the oven is ready. The oven will continue to maintain this temperature until the cooking feature is canceled.



For best results

- When baking with a single rack use rack positions 2 or 3. When using 2 racks use rack positions 2 & 5. When using 3 racks use rack positions 2, 3 & 5.
- Cookies and biscuits should be baked on pans with no sides or very low side to allow heated air to circulate around the food.
- Food baked on pans with a dark finish will cook faster.
- When placing multiple food items in the oven allow 2-4" (5-10cm) of space between the food items for proper air circulation.

NOTE

- You may press **CANCEL** any time when setting the control or when cooking.

Using convection convert

The conv convert option allows you to convert any normal baking recipe using the convection bake feature. The control uses the normal recipe settings and adjusts to a lower temperature for convection baking. Conv convert must be used with CONV BAKE feature.

Benefits of conv bake using conv convert option:

- Superior multiple oven rack performance.
- Some foods cook up 25 to 30% faster, saving time and energy.
- No special pans or bakeware required.



For best results





- Place food items using the recommended rack positions. When baking with a single rack use rack positions 2 or 3. When using 2 racks use rack positions 2 and 5. When using 3 racks use rack positions 2, 3 and 5.
- Cookies and biscuits should be baked on pans with no sides or very low side to allow heated air to circulate around the food.
- Food baked on pans with a dark finish will cook faster.
- When placing multiple food items in the oven allow 2-4" (5-10cm) of space between the food items for proper air circulation.

NOTE

- You may press CANCEL any time when setting the control or during the cooking process.

Setting convection convert

See the example below to set conv bake, starting immediately with the auto-suggest (default) setting of 350°F (176°C) and adding the conv convert option.

Example	
Step	Press
1. Press UPPER OVEN	
2. Press CONV BAKE	
3. Press COOK OPTIONS	
4. Press CONV CONVERT	
5. Press START/enter	

Once **START** is pressed the oven display shows **PRE-HEATING**. After the oven reaches the converted set temperature, **PRE-HEATING** will turn off and a beep will indicate the oven is ready.

The added conv convert option will automatically **lower** the set temperature you set from the bake recipe to an adjusted conv bake temperature.

When conv convert is used with cook time the time remaining will flash when the cook time is 75% complete. The control will also beep at regular intervals until baking has finished.

To add or change any cook settings after this feature has started:

- Wake control panel from the sleep mode if necessary.
- Select the **UPPER** or **LOWER** oven you wish to change. Make temperature changes using the + or - keys. Each press of + or - will adjust the temperature by 5° F (or 2°C).
- If changing cooking times, select the **cook time** or **end time** keys needed to make the changes.

28 Setting Oven Controls

About convection roast

How convection roast works

Convection roast is part of the Perfect-Convect³™ system. Convection roast combines a cook cycle with the convection fan and element to rapidly roast meats and poultry. Heated air circulates around the meat from all sides, sealing in juices and flavors. Meats cooked with this feature are crispy brown on the outside while staying moist on the inside. In addition, there is no need to reduce the oven temperature when using convection roast.

Convection roast may be set with the following options:

- Probe
- Cook time or cook time with end time
- Rapid preheat

The following temperature settings apply to convection roast:

- Factory auto-start default: **350°F/176°C**
- Minimum: **170°F / 76°C**
- Maximum: **500°F / 260°C**

Benefits of convection roast:

- Superior multiple oven rack performance.
- Some foods cook up 25 to 30% faster, saving time and energy.
- No special pans or bakeware required.



For best results

- Preheating is not necessary for most meats and poultry.
- Place food items using the recommended rack positions for the type of food being prepared.
- When placing multiple food items in the oven allow 2-4" (5-10cm) of space between the food items for proper air circulation.
- Be sure to carefully follow your recipe's temperature and time recommendations or refer to the convection roast chart for additional information -p. 29, Fig. 2-.

Setting convection roast

See example below to set convection roast to start immediately with the auto-suggest (default) setting:

Example	
Step	Press
1. Press UPPER OVEN	
2. Press CONV ROAST	
3. Press START/enter	

Once START is pressed the oven will begin heating. The oven display shows PRE-HEATING.

After the oven reaches set temperature, PRE-HEATING will turn off and a beep will indicate the oven is ready.

NOTE

- You may press CANCEL any time when setting the control or during the cooking process.

To add or change any cook settings after this feature has started:

- Wake control panel from the sleep mode if necessary.
- Select the **UPPER** or **LOWER** oven you wish to change. Make temperature changes using the + or - keys. Each press of + or - will adjust the temperature by 5° F (or 2°C).
- If changing cooking times, select the **cook time** or **end time** keys needed to make the changes.

Roasting recommendations

Roasting rack instructions

When preparing meats for convection roasting, you may use the broiler pan, insert and the roasting rack supplied with your appliance. The broiler pan will catch grease spills and the insert will help prevent grease splatters. The roasting rack fits on top of the insert allowing the heated air to circulate under the food for even cooking and helps to increase browning on the underside.

1. Place oven rack on bottom or next to the bottom oven rack position.
2. Place the insert on the broiler pan.
3. Make sure the roasting rack is securely seated on top of the insert. **Do not** use the broiler pan without the insert. **Do not** cover the insert with aluminum foil.
4. Position food (fat side up) on the roasting rack.
-Fig. 1-
5. Place prepared food on oven rack in the oven.

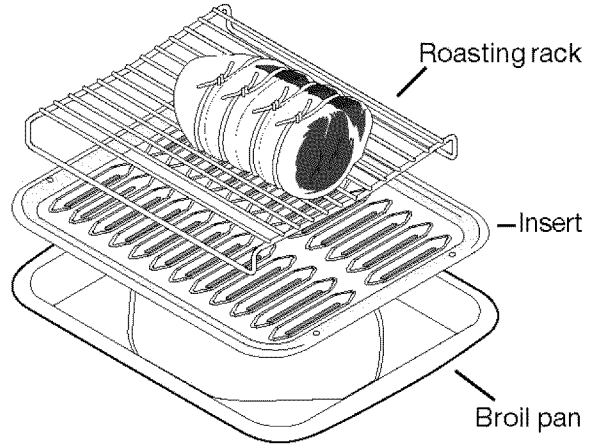

Fig. 1

Convection Roasting Chart

Meat	Weight	Oven temp	Internal temp	Minute per lb.	
Standing rib roast	4 to 6 lbs.	350°F	*	25-30	
Beef	Rib eye roast	4 to 6 lbs.	350°F	*	25-30
	Tenderloin roast	2 to 3 lbs.	400°F	*	15-25
Poultry	Turkey, whole**	12 to 16 lbs.	325°F	180°F	8-10
	Turkey, whole**	16 to 20 lbs.	325°F	180°F	10-15
	Turkey, whole**	20 to 24 lbs.	325°F	180°F	12-16
	Chicken	3 to 4 lbs.	350°F -375°F	180°F	12-16
Pork	Ham roast, fresh	4 to 6 lbs.	325°F	160°F	30-40
	Shoulder blade roast	4 to 6 lbs.	325°F	160°F	20-30
	Loin	3 to 4 lbs.	325°F	160°F	20-25
	Pre-cooked ham	5 to 7 lbs.	325°F	160°F	30-40

* For beef: med rare 145°F, med 160°F, well done 170°F

Fig. 2

** Stuffed turkey requires additional roasting time. Shield legs and breast with foil to prevent overbrowning and drying of the skin.

30 Setting Oven Controls

About the probe function

Checking the internal temperature of your food is the most effective way of insuring that your food has been properly cooked. When cooking meat such as roasts, hams or poultry you can use the probe to check the internal temperature without any guesswork.

Your oven will automatically change from cooking to keep warm once the probe has reached the set temperature.

The following temperature settings apply to the probe function:

- Default: **170°F/76°C**
- Minimum: **130°F/54°C**
- Maximum: **210°F/98°C**

Setting the probe

Proper probe placement

- Always insert the probe so that the tip rests in the center of the thickest part of the meat. Do not allow the probe to touch bone, fat, gristle or the pan.
- For bone-in ham or lamb, insert the probe into the center of the lowest large muscle or joint. For dishes such as meat loaf or casseroles, insert the probe into the center of the food. To find the center of the food visually measure with the probe -Fig. 3-. When cooking fish, insert the probe just above the gill.
- For whole poultry or turkey, insert the probe into the thickest part of the inner thigh, below the leg -Fig. 1-.

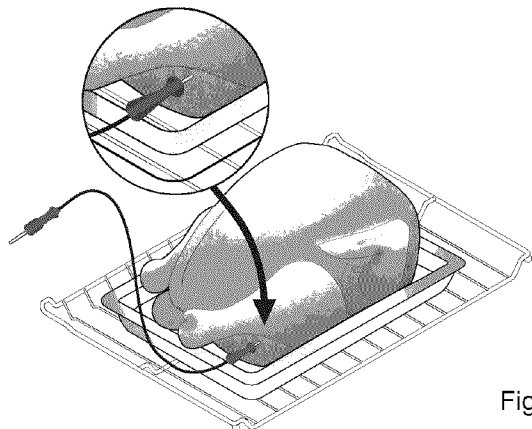

Fig. 1

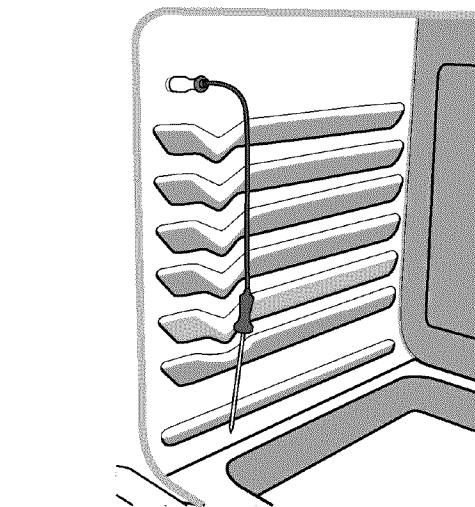

Fig. 2

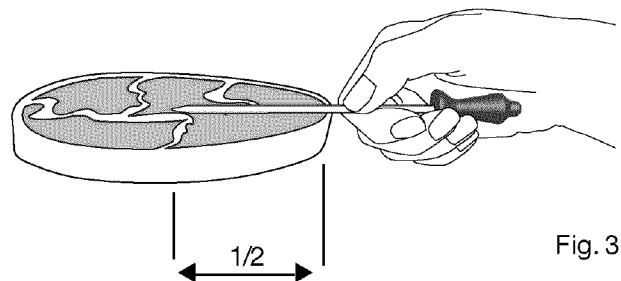





Fig. 3

IMPORTANT

- Use only the probe supplied with your appliance; any other may result in damage to the probe or the appliance.
- Be sure the probe is **fully** inserted into the probe receptacle. The probe will not work properly until correctly connected.
- Handle the probe carefully when inserting and removing it from the food and the receptacle.
- Do not use tongs to pull the cable when inserting or removing it from the food or the receptacle.
- Defrost your food completely before inserting the probe to avoid damaging probe.
- **Never leave or store the probe inside the oven when not in use.**
- To prevent the possibility of burns, carefully unplug the probe using a pot holder.

Setting the probe



See the example below to set the probe target temperature to 180°F/82°C when using the convection roast feature with oven set temperature for 325°F/162°C.

Example	
Step	Press
1. Insert the probe into the food and place the food into the oven -p. 30, Fig. 1-	
2. Plug the probe COMPLETELY into the probe receptacle inside the oven -p. 30, Fig. 2- and close the oven door.	
3. Press UPPER OVEN	UPPER OVEN
4. Press CONV ROAST	
5. Enter 325	325
6. Press COOK OPTIONS *	
7. Press PROBE	
8. Enter 180	180
9. Press START/enter	

* You may skip steps 6-8 if you choose to use the default internal target temperature of 170°F for the probe.

By the default, your oven will adjust to the **keep warm** setting once the probe has reached the set temperature.

NOTE

Any time during the cooking process you may press  once to see the current internal meat temperature reported by the probe. Press  twice to review or change the probe target temperature.

32 Setting Oven Controls

About convection broiling

Convection broiling is part of the Perfect-Convect³™ system. Use the conv broil feature to cook thicker cuts of meats that require direct exposure to radiant heat and the convection fan for optimum browning results. This cooking feature is only available for the upper oven.

The following temperature settings apply to the conv broil feature:

- Auto-suggest (default) setting: **550°F / 288°C**
- Min. convection broil setting: **300°F / 148°C**
- Max. convection broil setting: **550°F / 288°C**

WARNING

Should an oven fire occur, leave the oven door closed and turn the oven OFF. If the fire continues, throw baking soda on the fire or use a fire extinguisher. **Do not** put water or flour on the fire. Flour may be explosive and water can cause a grease fire to spread and cause personal injury.

CAUTION

- **Do not** use the broiler pan without the insert. **Do not** cover the the broil pan or insert with aluminum foil; the exposed grease could ignite.
- To prevent food from contacting the broil element and to prevent grease splattering, **do not** use the roasting rack when broiling.





For best results

- Use the recommended pans and rack positions. *-p.25 Figs. 2 & 4-*
- For optimum results preheat oven for 5-6 minutes.

Setting convection broil

See example below to set conv broil for the upper oven to start immediately with the auto-suggest (default) setting.

Example

Step	Press
1.	Place the broiler insert on the broiler pan, then place the meat on the insert. Remember to follow all warnings and cautions.
2.	Arrange the interior oven rack <i>-p. 25 Figs. 2 & 4-</i> for position recommendations. Be sure to place the prepared food and pan directly under broil element. Close the oven door <i>-p. 25 Fig. 1-</i> .
3.	Press UPPER OVEN 
4.	Press CONV BROIL 
5.	Press START/enter 

NOTE

You may press CANCEL any time when setting the control or during the cooking process.

To add or change any cook settings after this feature has started:

- Wake control panel from the sleep mode if necessary.
- Select the **UPPER** or **LOWER** oven you wish to change. Make temperature changes using the + or - keys. Each press of + or - will adjust the temperature by 5° F (or 2°C).
- If changing cooking times, select the **cook time** or **end time** keys needed to make the changes.

About keep warm

Use the keep warm feature to keep hot foods warm. Keep warm may be set with the following options:

- Cook time
- Cook time with end time

The following temperature settings apply to the keep warm feature:

- Auto-suggest (default) setting: **170°F / 76°C**
- Min. keep warm setting: **150°F / 66°C**
- Max. keep warm setting: **190°F / 88°C**

WARNING



- **FOOD POISONING HAZARD. Do not let food sit for more than one hour before or after cooking. Doing so may cause bacteria to grow which can result in food poisoning or sickness.**
- To prevent food from contacting the broil element and to prevent grease splattering, **do not** use the roasting rack when broiling.

NOTE

You may press CANCEL any time when setting the control or during the cooking process.

Setting keep warm

See example below to set keep warm for the upper oven to start immediately with the auto-suggest (default) setting.

Example	
Step	Press
1. Press UPPER OVEN	
2. Press KEEP WARM	
3. Press START/enter	

To add or change any cook settings after this feature has started:

- Wake control panel from the sleep mode if necessary.
- Select the **UPPER** or **LOWER** oven you wish to change. Make temperature changes using the + or - keys. Each press of + or - will adjust the temperature by 5° F (or 2°C).
- If changing cooking times, select the **cook time** or **end time** keys needed to make the changes.

34 Setting Oven Controls

About slow cook

The slow cook feature may be used to cook foods more slowly at lower oven temperatures. The cooking results will be like that of a Slow Cooker or Crock-Pot. This feature is ideal for roasting beef, pork & poultry. Slow cooking meats may result in the exterior of meats becoming dark but not burnt; this is normal. Slow cook may be set in the upper or lower oven.

Slow cook may be set with the following options:

- Cook time
- Cook time with end time

The following temperature settings apply to the slow cook feature:

- Hi: 275°F / 134°C (default) for cooking 4 to 5 hours
- Lo: 225°F / 108°C for cooking 8 to 9 hours



For best results

- Completely thaw all frozen foods before cooking.
- When using a single oven rack, place in position 2 or 3.
- Position multiple racks to accommodate size of cooking utensils when cooking multiple food item.
- Add any cream or cheese sauces during the last hour of cooking.
- Do not open the oven door often or leave the door open when checking foods. The more heat that is lost, the longer the food will need to cook.
- Cover the foods to keep them moist or use a loose or vented type cover to allow foods to turn crisp or brown.
- Roasts may be left uncovered so browning can occur. Cook times will vary depending on the weight, fat content, bone & the shape of the roast.
- Preheating the oven will not be necessary.

Setting slow cook

See the example below to set a slow cook on Lo.

Example	
Step	Press
1. Press UPPER OVEN*	UPPER OVEN
2. Press SLOW COOK	
3. Press -lo to choose the Lo option -Fig. 2-	- lo
4. Press START/enter	

*Choose the lower oven to use slow cook in the lower oven.

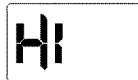

Fig.1



Fig. 2

NOTE

You may press CANCEL any time when setting the control or during the cooking process.

To add or change any cook settings after this feature has started:

- Wake control panel from the sleep mode if necessary.
- Select the **UPPER** or **LOWER** oven you wish to change. Make temperature changes using the + or - keys. Each press of + or - will adjust the temperature by 5° F (or 2°C).
- If changing cooking times, select the **cook time** or **end time** keys needed to make the changes.

About Perfect Turkey™

Heated air circulates around the turkey from all sides, sealing in juices and flavors. Poultry cooked with this feature are crispy brown on the outside while staying moist on the inside.

Perfect turkey combines a cook cycle with the convection fan. The probe is used to monitor the exact internal temperature of the turkey while cooking. Once the turkey has reached the set temperature, the oven will stop cooking and change to keep warm.



Before setting the perfect turkey feature, or if you would like to change the probe target temperature, be sure to carefully read and follow **setting the probe** instructions - See steps 6-9, p. 31.

NOTE

- You may press CANCEL any time when setting the control or during the cooking process.
- Any time during the cooking process you may press PROBE once to see the internal meat temperature reported by the probe. Press PROBE twice to review the probe set temperature.
- It is not recommended to modify the perfect turkey settings once cooking has started. Doing so may not provide the best results.

Setting Perfect Turkey™

See the example below to use perfect turkey at the default setting of 325°F and the probe at the default setting of 180°F (82°C).

Example	
Step	Press
1. Insert the probe into the thickest part of the meat and place the turkey in the oven -p. 30 Fig 1.	
2. Plug the probe into the probe receptacle inside the upper oven.	
3. Press UPPER OVEN	UPPER OVEN
4. Press PERFECT TURKEY Probe indicator will flash and Perfect Turkey will not start until the probe has been plugged in.	
5. Press START/enter	

Perfect Turkey Chart

Meat	Weight	Oven temp	Internal temp	Minute per lb.
Turkey, whole*	12 to 16 lbs.	325°F	180°F	8-10
Poultry				
Turkey, whole*	16 to 20 lbs.	325°F	180°F	10-15
Turkey, whole*	20 to 24 lbs.	325°F	180°F	12-16
Chicken	3 to 4 lbs.	350°F -375°F	180°F	12-16

* Stuffed turkey requires additional roasting time. Shield legs and breast with foil to prevent overbrowning and drying of the skin.

36 Setting Oven Controls

About defrost

Use the defrost feature to thaw small portions of delicate items such as cream cakes, frozen cream pies and cheesecake at room temperature. The Defrost feature can only be used in the upper oven. While in the defrost mode, the convection fan will operate to circulate room temperature air around the food slowly, accelerating the natural defrosting of the food without using heat.

Defrost may be set with the following options:

- Cook time
- Cook time with end time

Setting defrost

See the example below to set defrost.

Example	
Step	Press
1. Place food in oven and press UPPER OVEN	
2. Press DEFROST	
3. Press START/enter	

NOTE

- You may press **CANCEL** any time when setting the control or during the cooking process.
- This feature is not meant for thawing frozen meats, poultry, seafood or other foods that need to be cooked before serving. Follow USDA recommendations for thawing foods. Only frozen foods that can be defrosted and served without cooking should be used with this feature.

About dehydrate



The dehydrate feature dries with heat from the convection element. The heat is circulated throughout the oven by the convection fan. Use dehydrate to dry and/or preserve foods such as fruits, vegetables, herbs and very thin slices of meat. Dehydrate may be set in the upper oven only. The Convection fan may operate while dehydrating.

The following temperature settings apply to the dehydrate feature:

- Auto-suggest (default) setting: **120°F / 48°C**
- Min. dehydrate setting: **100°F / 38°C**
- Max. dehydrate setting: **225°F / 108°C**

Setting dehydrate

See the example below to set dehydrate at the default temperature of 120°F.

Example	
Step	Press
1. Press UPPER OVEN	
2. Press DEHYDRATE	
3. Press START/enter	

To add or change any cook settings after this feature has started:

- Wake control panel from the sleep mode if necessary.
- Select the **UPPER** or **LOWER** oven you wish to change. Make temperature changes using the **+** or **-** keys. Each press of **+** or **-** will adjust the temperature by 5° F (or 2°C).
- If changing cooking times, select the **cook time** or **end time** keys needed to make the changes.

Setting dehydrate



For best results

- Dry most fruits and vegetables at 140°F. Dry herbs at 100°F.
- Drying times vary depending on the moisture and sugar content of the food, the size of the pieces, the amount being dried and the humidity in the air.
- Treat fruits with antioxidants to avoid discoloration.
- Tightly woven cooling racks can be used to allow the air to circulate around the food; or use drying racks to allow the air to circulate around the food (this type of oven rack is not supplied with this appliance).
- Consult a food preservation book or library for information.

About bread proof

The bread proof feature maintains a warm environment useful for rising yeast-leavened products. Bread proof may be set in the upper oven only.

Bread proof may be set in conjunction with the following feature:

- My favorite

The following temperature settings apply to the bread proof feature:

- Auto-suggest (default) setting: **100°F/38°C**
- Min. bread proof setting: **85°F/30°C**
- Max. bread proof setting: **100°F / 38°C**



For best results

- Lightly cover the dough
- Place a bowl of hot water on the rack below.
- Use the oven light to check progress. Do not open the oven door.

Setting bread proof

See example below to set bread proof for 85°F / 30°C.

Example	
Step	Press
1. Press UPPER OVEN	UPPER OVEN
2. Press BREAD PROOF	
3. Press and continue to press -lo to advance to 85°F	- lo
4. Press START/enter	

NOTE

You may press CANCEL any time when setting the control or during the cooking process.

To add or change any cook settings after this feature has started:

- Wake control panel from the sleep mode if necessary.
- Select the **UPPER** or **LOWER** oven you wish to change. Make temperature changes using the + or - keys. Each press of + or - will adjust the temperature by 5° F (or 2°C).
- If changing cooking times, select the **cook time** or **end time** keys needed to make the changes.

38 Setting Oven Controls



About my favorite

You may store up to 6 of your most frequently used heat settings and cooking times, three for each oven. These keys will light in the display when they are available for setting or recalling.

Each key will allow you to store a cooking feature, oven set temperature and a cook time for either the upper oven or lower oven.

Saving my favorite instructions



All the favorite keys will display after selecting the upper or lower oven. The example below shows how to save a favorite cooking instruction for the upper oven.

Example	
Step	Press
1. Press UPPER OVEN	UPPER OVEN
2. Input the cooking instructions using the control keypads and any additional options you wish to save and later recall.	
3. Press START	
4. Press and hold the available MY FAVORITE for 3 seconds	
5. Press CANCEL/off*	

You will hear a beep and a red light will display above the selected favorite to indicate that your favorite recipe has been stored.

*If you wish to store the cooking instructions but not start the oven.

Recalling a favorite

Example	
Step	Press
1. Press UPPER OVEN	UPPER OVEN
2. Choose MY FAVORITE	
3. Press START/enter	

Deleting/overwriting a favorite

Once all 3 favorites have been filled you may choose to overwrite an existing favorite. Follow the same instructions to save a recipe; choose the favorite you wish to overwrite and hold for 3 seconds.

It is not necessary to delete a favorite before saving another. Choose one of the favorite keys you no longer wish to keep and store the new cooking instructions using the overwriting instructions.

Perfect Program™ multi stage

Multi stage will allow you to program up to 3 stages of cooking. Each stage may be programmed with a cooking feature, set temperature and a cook time. Multi stage is ideal when you want to add a keep warm after a cooking function.





The following functions may be set with multi stage:





- Bake/conv bake
- Broil/conv broil (10 minutes max.)
- Conv roast
- Bread Proof
- Keep warm

Setting multi stage

See the example to program a multi stage feature for a casserole. For stage 1, bake at 350°F for 1 hr. For stage 2, to brown, broil for at 500°F for 4 minutes.

Example for 2 stages

Step	Press
1. Press UPPER OVEN	
2. Press MULTI STAGE	
<hr style="border: 0; border-top: 1px solid black; margin: 10px 0;"/>	
<i>Stage 1</i>	
3. Press BAKE	
4. Enter 350°F	350
5. Press START/enter	
6. Enter 60 minutes	60
7. Press START/enter	



<hr style="border: 0; border-top: 1px solid black; margin: 0 20px;"/>	
<i>Stage 2</i>	
8. Press BROIL	
9. Enter 500°F	500
10. Press START/enter	
11. Enter 4 minutes	4
12. Press START/enter a total of 2 times to program only 2 stages and begin cooking.	 





40 Setting Oven Controls

Setting multi stage

See the example to program a multi stage feature for a casserole. For stage 1, bake at 350°F for 1 hr. For stage 2, to brown, broil for at 500°F for 4 minutes. For stage 3, keep warm for 15 minutes.

Example for 3 stages

Step	Press
1. Press UPPER OVEN	
2. Press MULTI STAGE	
<hr/> <i>Stage 1</i>	
3. Press BAKE	
4. Enter 350°F	350
5. Press START/enter	
6. Enter 60 minutes	60
7. Press START/enter	
<hr/> <i>Stage 2</i>	
8. Press BROIL	
9. Enter 500°F	500
10. Press START/enter	
11. Enter 4 minutes	4
12. Press START/enter	

<hr/> <i>Stage 3</i>	
13. Press KEEP WARM	
14. Enter 170°F	170
15. Press START	
16. Enter 15 minutes	15
17. Press START a total of 2 times to start cooking immediately.	 

Sabbath mode

This appliance provides special settings for use when observing the Jewish Sabbath/Holidays. The Sabbath mode will turn OFF all audible tones and visual display changes normally reported by the oven control. **BAKE** is the only cooking feature available while in the Sabbath mode.

You must first set the **BAKE** feature and temperature(s) needed for the upper/lower oven(s) and the **COOK TIME** option if needed before setting the Sabbath mode. Any settings made prior to setting the Sabbath mode will be visible in the displays. The **COOK TIME** option, if set prior to the Sabbath mode, will give 1 audible alert at the end of **COOK TIME**.

The cooktop will no longer be available whenever the Sabbath mode is active.

The Sabbath mode will override the factory preset 12 Hour Energy Saving mode and the appliance will stay on until the cooking features are cancelled. If any of the cooking features are cancelled when the appliance is in the Sabbath mode, no audible or visual indicators will be available to verify the cancellation.

If the oven interior lights are needed, be sure to activate them prior to setting the Sabbath mode. Once the oven light is turned ON and the Sabbath mode is active, the oven light will remain on until the Sabbath mode is turned off and the oven lights are turned off. The oven door will not activate the oven interior lights when the oven door is opened or closed.

Please note - it is recommended that any oven temperature adjustments made within an active Sabbath mode be followed with **two presses** of the **START** key. This will insure the oven remains ON even if an attempt is made to set the oven temperature outside of its temperature range. If the oven temperature is set outside of the temperature range, the oven will default to the nearest available temperature. Try to set the desired oven temperature again.

Should a power failure or interruption occur during the Sabbath/Holidays, the appliance will shut OFF. When power is restored the appliance will not turn back on automatically to the original **BAKE** feature settings. **SF** will appear in the oven control display and “- -” in the cooking zone displays indicating a Sabbath mode failure. - *Figs. 1 & 2* -

After a power failure, the food may be safely removed from the oven.

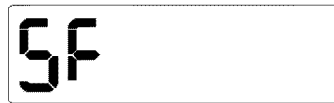

Fig. 1

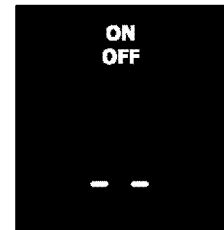

Fig. 2

For further assistance, guidelines for proper usage and a complete list of models featuring the Sabbath mode, please visit the web at <http://www.star-k.org>.



42 Setting Oven Controls

Setting Sabbath mode

The example below shows setting the oven to observe the Sabbath (and Jewish holidays).

Example	
Step	Press
1. Press UPPER or LOWER OVEN	UPPER OVEN or LOWER OVEN
2. Press BAKE .	
Be sure to make any additional oven setting changes before going to step 3.	
3. To activate the Sabbath mode, press and hold both the LO and HI keys together for 3 seconds (a beep will sound) and release:	- & + lo & hi

Once properly set for Sabbath mode, **SAb** -Fig. 1- will show in oven display and - - will appear in all individual cooktop displays until the Sabbath mode is cancelled -Fig. 2- .

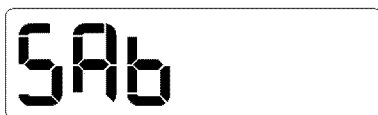

Fig. 1

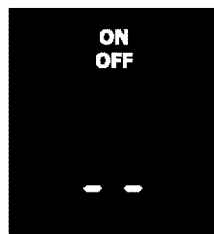





Fig. 2

Canceling Sabbath mode

The example below shows how to cancel the Sabbath mode.

Example	
Step	Press
1. Press and hold both the LO and HI keys together for 3 seconds (a beep will sound) and release:	- & + lo & hi
2. Any active cooking feature set will automatically stop once Sabbath mode is cancelled.	

NOTES

The only keys available once the appliance is set for the Sabbath mode are , ,  and the numeric key pads .

You may adjust the oven temperature once baking has started (Jewish holidays only). To adjust the oven temperature, choose oven and press **BAKE**, enter the new oven temperature (from 170 to 500F°) and press **START**. Remember that **the oven control will no longer beep or display any further adjustments** once the oven is set for the Sabbath mode.

Perfect Pair™ lower oven

The lower oven provides two basic modes, cooking and warming. The lower oven is ideal for cooking foods such as pizza, casseroles, baked potatoes and frozen convenience foods. Use the keep warm feature to keep hot cooked foods at serving temperature.

These features are available for the lower oven.

- Bake
- Slow cook -pg.34.
- Keep warm

WARNING

- **KEEP CHILDREN AWAY FROM THE LOWER OVEN WHEN HOT. FAILURE TO DO SO CAN RESULT IN BURNS.**

Recommendations for lower oven

- When placing food in the lower oven always use a baking sheet or pan with 4 raised sides to prevent food from sliding off.
- **DO NOT LINE THE OVEN DRAWER WITH FOIL OR COVER THE OVEN RACK WITH FOIL.** This may result in damage to your oven.
- The maximum height of foods and utensils that may be used in the lower oven is 4". The maximum width is 15". **Pay close attention to foods that have potential to rise beyond the recommended 4" maximum height.**
- Use pans in the lower oven large enough to contain food and any juices created from the cooking process.
- **Do not use plastic wrap to cover food. Plastic may melt onto the drawer or surrounding areas and be very difficult to clean.** Use a lid or aluminum foil instead. Use only utensils and cookware in the oven drawer that are recommended for oven use in the upper oven.

CAUTION

- Always use oven mitts when removing food from the lower oven. The lower oven rack, compartment, cookware/plates may be hot.
- Should an oven fire occur, close the drawer and turn the lower oven OFF. If the fire continues, use a fire extinguisher. **Do not** put water or flour on the fire. Flour may be explosive.



For best results

- The lower oven rack **must always be in place when cooking or warming.** Be sure that the rack is placed with the down turned sides into the drawer -Fig. 1-. This will provide for some air space between the drawer and the food.
- For best results with the lower oven, pastries, casseroles with crumb toppings and bakery type items should be cooked in the upper oven.
- When using the lower oven, limit the number of times the drawer is opened; this will minimize heat loss. Repeated opening of the drawer during the cooking process may increase cooking times and produce uneven cooking results. The cooking times for the lower oven may vary slightly from the upper oven.

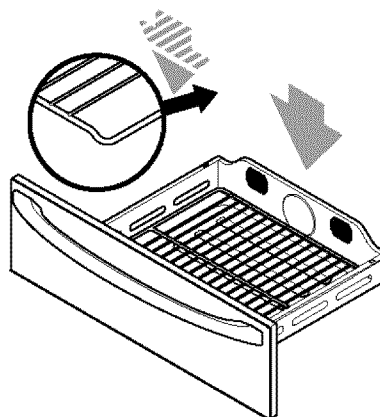

Fig. 1

44 Setting Lower Oven Controls

Baking in the lower oven

Use the bake feature to cook food items with normal cooking temperatures.

Bake may be set with the following options:



- Cook time
- Cook time with end time

The following temperature settings apply to the bake feature:

- Auto-suggest (default) setting: **350°F/176°C**
- Min. bake setting: **170°F / 76°C**
- Max. bake setting: **450°F / 232°C**

Setting bake for lower oven

See example below to set a bake to start immediately using the default temperature.

Example	
Step	Press
1. Press LOWER OVEN	
2. Press BAKE	
3. Press START/enter	

Once **START** is pressed the lower oven will begin heating. The oven display shows **PRE-HEATING**.

After the lower oven reaches set temperature, **PRE-HEATING** will turn off and a beep will indicate the oven is ready. The oven will continue to maintain this temperature until the bake feature is canceled.

NOTE

You may press **CANCEL** any time when setting the control or during the cooking process.

About keep warm in the lower oven

Use the keep warm feature to keep cooked foods warm.

When using keep warm always start with hot food. Do not heat cold food.

Keep warm may be set with the following options:

- Cook time
- Cook time with end time

The following temperature settings apply to the keep warm feature:

- Auto-suggest (default) setting: **170°F/76°C**
- Min. keep warm setting: **150°F / 66°C**
- Max. keep warm setting: **190°F / 88°C**

If you enter a temperature beyond this range your control will automatically default to the nearest temperature available.

WARNING

- **FOOD POISONING HAZARD. Do not let food sit for more than one hour before or after cooking. Doing so can result in food poisoning or sickness.**

NOTE



- The lower oven will not operate when the upper oven is set for self-cleaning or the control lock feature is active.
- If the lower oven is **ON** and a self-clean or control lock request is attempted, the oven control will deny the request with a triple beep.

To add or change any cook settings after this feature has started:

- Wake control panel from the sleep mode if necessary.
- Select the **UPPER** or **LOWER** oven you wish to change. Make temperature changes using the **+** or **-** keys. Each press of **+** or **-** will adjust the temperature by 5° F (or 2°C).
- If changing cooking times, select the **cook time** or **end time** keys needed to make the changes.

Setting keep warm in the lower oven

See example below to set keep warm for the lower oven to start at 190°F / 88°C.

Example	
Step	Press
1. Press LOWER OVEN	
2. Press KEEP WARM	
3. Use +hi to increase the temp. to 190°F.	+ hi
4. Press START/enter	

NOTE

- Use the **+hi** key to increase from the default keep warm temperature. Use the **-lo** to decrease the temperature.
- You may press CANCEL any time when setting the control or during the cooking process.

Lower oven cleaning tips

For easier cleanups, the lower oven should be cleaned as soon as the oven cools down. Clean after each use to minimize buildup of spatter and food leftovers. When cooking foods that spatter, cover the food with heatproof lid or foil. Use a mild detergent and water to clean the oven drawer and sides. For stubborn soils use a nonabrasive cleaning pad to remove soils. **DO NOT** use oven cleaners on the oven cavity.

Temperature selection

See the recommended settings chart below for keep warm. If a particular food is not listed, use the default temperature of 170°F. If more crispness is desired, remove the lid or aluminum foil from the food. Most foods can be kept at serving temperatures at 170°F. When a combination of foods are to be kept warm (for example a meat with 2 vegetables and rolls) use 170°F.





Keep Warm Recommended Food Settings	
Food Item	Heating Level
Hot Beverages	190°F
Fried Foods	190°F
Vegetables	170°F
Soups (Cream)	170°F
Stews	170°F
Sauces	170°F
Meats	170°F
Gravies	150°F
Eggs	150°F
Dinner Plates with Food	150°F
Casseroles	150°F
Breads/Pasteries	150°F

46 Setting Your Preferences

Wave-Touch™ user preferences



The  key controls options for preferences. The display will show a digital abbreviation and a value for every preference each time a key is pressed one at a time.

Please read the following instructions before changing the user preferences functions:

- Press and continue to press USER PREF  to navigate through the preferences.
- Press **+**
hi or **-**
lo to toggle between options for each preference.
- Press **+**
hi or **-**
lo to increase or decrease numeric values. You may also use the numeric keys to input precise values.
- Press START  to accept a new option entry or press USER PREF  to advance to the next preference.
- Press CANCEL  after pressing START  to exit the preferences mode .

Setting clock (CLO)



See the example below to set the clock to 1:30.

Example	
Step	Press
1. Press USER PREF .	
2. Enter 1:30 or use +hi/-lo to advance to 1:30.	130
3. Press START/enter to accept or press CANCEL/off to reject.	

Setting clock display (CLO)

The clock display mode allows you to turn the clock display on or off.

See the example below to change the clock display to OFF.

Example	
Step	Press
1. Press and continue to press USER PREF until you reach the pre-set clock display mode -Fig. 1-.	
2. Use the +hi & -lo to toggle to the CLO off option -Fig. 2-.	+ hi or - lo
3. Press START/enter to accept or press CANCEL/off to reject.	

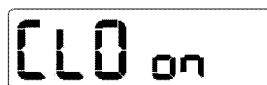

Fig. 1



Fig. 2

NOTE

User preference options are not available while cooking or when using the kitchen timer.

Setting 12 or 24 hour mode

The clock display mode allows you to choose between 12 and 24 hour mode. The factory pre-set clock display mode is 12 hour.

See the example below to change the default mode to 24 hour.

Example

Step Press

1. Press and continue to press **USER PREF** until you reach the pre-set **clock display mode** -Fig. 1-.



2. Use the **+hi** & **-lo** to toggle to the **24hr** option. -Fig. 2-

+ hi or **- lo**

3. Press **START/enter** to accept or press **CANCEL/off** to reject.



Fig. 1

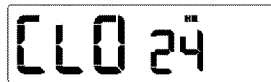

Fig. 2

Changing between F° or C° (F-C)

Your control has the ability to display and set Fahrenheit or Celsius temperatures. The factory pre-set temperature display is Fahrenheit.

See the example below to change the default temperature display to Celsius.

Example

Step Press

1. Press and continue to press **USER PREF** until you reach the **Fahrenheit/Celsius** mode. -Fig. 1-



2. Use the **+hi** or **-lo** to toggle to the **C** option. -Fig. 2-

+ hi or **- lo**

3. Press **START/enter** to accept or press **CANCEL/off** to reject.

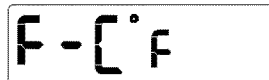

Fig. 1



Fig. 2

48 Setting Your Preferences

Setting 12hr energy saving mode (ES)

The oven control has a factory preset built-in 12 hour energy saving feature that will shut off the appliance if the oven has been heating for more than 11 hours and 59 minutes. The oven can be programmed to override this feature for continuous baking.

See the example below to turn off 12 hour energy saving mode.



Example	
Step	Press
1. Press and continue to press USER PREF until you reach the pre-set 12hr energy saving mode -Fig. 1-	
2. Use the +hi & -lo to toggle to the off option -Fig. 2-	+ hi or - lo
3. Press START/enter to accept or press CANCEL/off to reject.	



Fig. 1

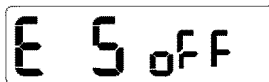

Fig. 2

Setting audio mode (AUD)

The audio mode allows you choose between 6 levels of audio volume for the oven control. You may turn the audio off and later return to operating with all the normal audible sounds and alerts. The preheat and cook time features will still beep to alert you when to put your food in and take it out. The factory pre-set audible level is 5.

See the example below when changing the audible level settings.



Example	
Step	Press
1. Press and continue to press USER PREF until you reach the pre-set AUD mode.	
2. Use the +hi or -lo to choose desired audio level -Fig. 1 or to choose the off option -Fig. 2.	+ hi or - lo
3. Press START/enter to accept or press CANCEL/off to reject.	



Fig. 1

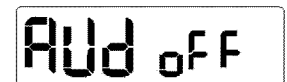

Fig. 2

Adjusting oven temperature User programmable offset (UPO)

Your appliance has been factory calibrated and tested to ensure an accurate baking temperature. For the first few uses, follow your recipe times and temperature recommendations carefully.

If you feel your oven is too hot or too cool from your baking experience, the oven temperature may be adjusted to your liking. The temperature may be increased up to +35°F (+19°C) or decreased down to -35°F (-19°C) from normal.

See the example below to decrease the temperature in the **upper oven**.

Example

Step	Press
------	-------

1. Press and continue to press USER PREF until you reach the pre-set UPO mode <i>-Figs. 1-</i>	
---	--

2. Press -lo to adjust the temperature lower.	- lo
--	----------------

3. Use -lo to advance to -10 <i>-Fig. 2-</i>	- lo or 10
--	-----------------------------

4. Press START/enter to accept or press CANCEL/off to reject.	
---	---

To set the temperature higher use the **hi+** key.



Fig. 1

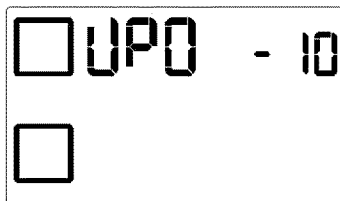

Fig. 2

Adjusting lower oven temperature (UPO)

The temperature may be increased +35°F (+19°C) or decreased -35°F (-19°C) from normal.

See the example below to increase the temperature in the **lower oven**.

Example

Step	Press
------	-------

1. Press and continue to press USER PREF until you reach the pre-set UPO mode. <i>-Fig 1 -</i>	
---	---

2. Press +hi to adjust the temperature higher. <i>-Fig. 2-</i>	+ hi
---	----------------

3. Use +hi to advance to 10 <i>-Fig. 2-</i>	+ hi or 10
--	-----------------------------

4. Press START/enter to accept or press CANCEL/off to reject.	
---	---

To set the temperature lower use the **lo-** key.



Fig. 1

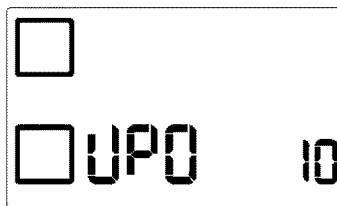

Fig. 2

50 Setting Your Preferences

Factory default reset (RST)

You may choose to restore your factory settings. **This will erase all settings or favorites that you have saved.**

See the example below reset your control.

Example

Step Press

1. Press and continue to press **USER PREF** until you reach the factory default reset mode.
-Fig. 1-



2. Use the **+hi** or **-lo** to toggle to the **yes** option to reset *-Fig. 1-*.

+ -
hi or lo

3. Press **CANCEL/off** if you decide not to reset.



Fig. 1

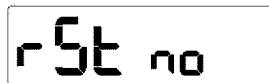



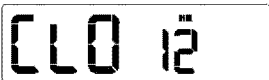
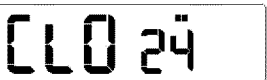
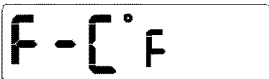
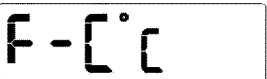
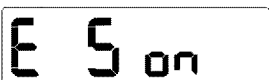









Fig. 2

User preferences chart

The following chart will help you navigate through the user preferences.

User Preferences Options		
Preference	1st option	2nd option*
Setting clock		
Clock display		
12 or 24 hour mode		
F° or C°		
12hr energy save mode		
Audio mode*		
UPO upper oven		
UPO lower oven		
Reset to factory pre-sets		

* Audio mode provides 6 possible settings.

Before starting self-clean

A self-cleaning oven automatically cleans with high temperatures that are well above those used for normal cooking. The self-clean feature eliminates soils completely or reduces them to a fine powdered ash that you can later easily wipe away with a damp cloth.

Adhere to the following precautions when running the self-clean cycle:

- **Do not** use oven cleaners or protective coatings in or around the oven interior.
- **Do not** clean the oven door gasket. The woven material of the oven door gasket is essential for a good seal. Care should be taken not to rub, damage or remove the gasket. *-Fig. 1-*
- **Do not** use any cleaning materials on the door gasket. Leaving chemical residue can damage the door gasket.
- **DO NOT** force the oven door open. The automatic door locking system can be damaged.
- **Remove** the broiler pan, insert, all utensils and any **aluminum foil**. These items cannot withstand high cleaning temperatures.
- All oven racks **MUST** be removed. If they are left in while attempting to set a self-clean cycle, the display will show **REMOVE RACKS** *-Fig. 2.* The oven control will not start a self-clean cycle without first removing all the oven racks.
- **Remove any excessive spillovers** in the oven cavity **before** starting a self-clean cycle. To clean, use hot, soapy water and a cloth. Large spillovers can cause heavy smoke or fire when subjected to high temperatures.
- Clean any soil from the oven frame, the door liner outside the oven door gasket and the small area at the front center of the oven bottom with soap and water. These areas heat sufficiently to burn soil on.
- **Do not** allow food spills with a high sugar or acid content (such as milk, tomatoes, sauerkraut, fruit juices or pie filling) to remain on the porcelain surface, they may leave a dull spot even after cleaning.

⚠ WARNING

During the self-clean cycle, the outside of the appliance can become very hot to the touch. **DO NOT** leave small children unattended near the appliance.

⚠ CAUTION

- **DO NOT** line the oven walls, oven racks, bottom or any other part of the range with aluminum foil. Doing so will stop heat distribution, produce poor baking results and cause permanent damage to the oven interior (aluminum foil will melt to the interior surface of the oven).
- Use caution when opening the door after the self-clean cycle is finished. The oven may still be **VERY HOT**.
- The health of some birds is extremely sensitive to the fumes given off during the self-cleaning cycle of any range. Move birds to another well-ventilated room.

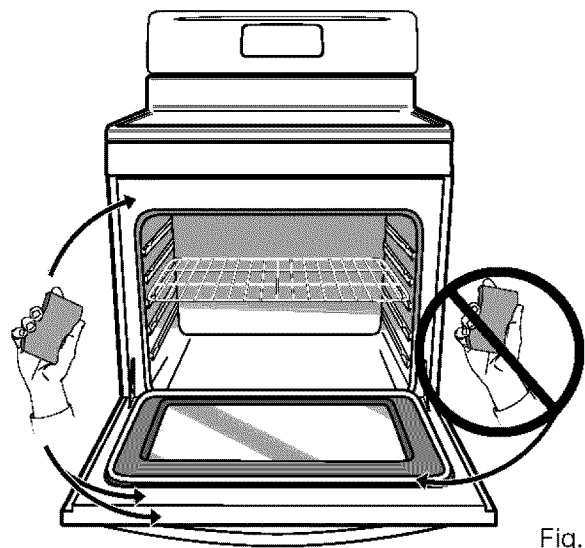

Fig. 1



Fig. 2

Setting self-clean

The clean feature provides 3 different choices for self-cleaning the upper oven. Set the clean for **lite** (2 hrs), **med** (3 hrs) or **heavy** soils (4 hrs). The example below shows setting the upper oven for self-clean to begin immediately using a medium (3 hour) setting:

Example	
Step	Press
1. Remove oven racks and press UPPER OVEN	UPPER OVEN
2. Press CLEAN	
3. Select MED or select lite or heavy	med
4. Press START/enter	

After pressing start, the motorized oven door latch will automatically lock the door. The DOOR lock icon will flash (Fig. 1). Once the door is locked the DOOR lock icon will remain on through the entire self-clean cycle. After self-clean, the oven may take 30-40 minutes to cool and the oven door to unlock. A **Hot** message (Fig. 2) will display during this time. After cooling the DOOR lock icon will flash and disappear indicating that the door has unlocked.



Fig. 1

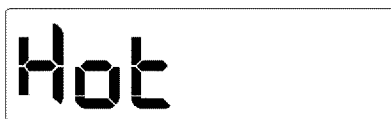

Fig. 2

➔ IMPORTANT

- The self-clean cycle will not start if ANY cooking zone remains active or the CONTROL LOCK is turned on.
- The surface cooking zones will not operate when the self-clean cycle is active.
- If a self-clean cycle was started but did not finish due to a power failure, your oven may not have thoroughly cleaned. Once power is restored and the oven door has unlocked, set for another self-clean if needed.

Setting delayed self-clean

You may wish to set your appliance to perform a self-clean cycle sometime later (up to 12 hours later). The **END TIME** key will determine when the cleaning will stop.

You will need to set the **END TIME** out far enough to allow for the type of clean cycle you choose (2-3-4 hours). Remember to add 30-40 additional minutes for the oven to cool enough and the oven door to unlock.

The example below shows setting the upper oven for a lite (2 hour) self-clean cycle to end at 8:00 o'clock:

Example	
Step	Press
1. Remove racks and press UPPER OVEN	UPPER OVEN
2. Press CLEAN	
3. Select LITE	lite
4. Press COOK OPTIONS	
5. Press END TIME	
6. Enter 800	800
7. Press START/enter	

🗨️ NOTES

- You may press **CANCEL** any time during the cleaning process. After cancelling the self-clean cycle, do not attempt to open the oven door until the DOOR lock icon turns off.
- If you desire to set a delayed self-clean cycle to end in 12-24 hours, use the **USER PREF** key to set the 12hr energy saving mode (ES) to OFF and also set the clock mode (CLO) to 24 hr.

Cleaning Recommendations

Surface Type	Cleaning Recommendation
<ul style="list-style-type: none"> • Painted body parts, decorative trim, aluminum & control knobs (some models) 	<p>For general cleaning, use hot, soapy water and a cloth. For more difficult soils and built-up grease, apply a liquid detergent directly onto the soil. Leave on soil for 30-60 minutes. Rinse with a damp cloth and dry.</p> <p>Do not use abrasive cleaners on any of these materials; they can scratch. To remove control knobs, turn to OFF position; grasp firmly and pull straight off the shaft. To replace knobs after cleaning, line up the flat sides of both knob and shaft; then push knob into place.</p>
<ul style="list-style-type: none"> • Control panel, control keypad membrane 	<p>Before cleaning the control panel, turn all controls OFF, activate oven lock (on some models) and cooktop lock (on some models) and remove control knobs (some models). Do not use abrasive cleaners on any of these materials; they can scratch. Clean using hot, soapy water and a dishcloth. Be sure to squeeze excess water from dishcloth before wiping control panel; especially when wiping around the controls area. Excess water in or around the controls may cause damage to the appliance. When rinsing, use clean water and a dishcloth and be sure to squeeze any excess water from dishcloth before wiping the control panel.</p>
<ul style="list-style-type: none"> • Porcelain coated enamel parts & door liner 	<p>Gentle scrubbing with a soapy no-scratch cleaning pad will remove most spots. Rinse with a 1:1 solution of clear water and ammonia. If necessary, cover difficult spots with an ammonia-soaked paper towel for 30 to 40 minutes. Rinse with clean water and a damp cloth, and then scrub with a soap-filled no-scratch cleaning pad. Rinse and wipe dry with a clean cloth. Do not allow food spills with high sugar or acid content (milk, tomatoes, sauerkraut, fruit juices or pie filling) to remain on the surface; they may cause a dull spot even after cleaning.</p>
<ul style="list-style-type: none"> • Oven interior 	<p>For oven interior remove excessive spillovers from oven cavity bottom before starting self-clean feature. Remove any soils from oven frame and door liner outside the oven door gasket. Do not use oven cleaners or protective coatings in or around oven interior. These can damage the porcelain finish. For very important cleaning precautions be sure to read all the instructions in the self-clean section.</p>
<ul style="list-style-type: none"> • Oven racks 	<p>Oven racks must be removed from oven cavity before starting self-clean. Remove from oven and clean by using a mild, abrasive cleaner following manufacturer's instructions. Rinse with clean water, let dry and then replace.</p>
<ul style="list-style-type: none"> • Oven door & door gasket 	<p>Use soap & water to thoroughly clean the top, sides and front of the oven door. Rinse well. You may use a glass cleaner on the outside glass of the oven door. Do not immerse the door in water. Do not spray or allow water or the glass cleaner to enter the door vents. Do not use oven cleaners, cleaning powders or any harsh abrasive cleaning materials on the outside of the oven door.</p> <p>Do not clean the oven door gasket. The oven door gasket is made of a woven material, on Self-Cleaning models, which is essential for a good seal. Care should be taken not to rub, damage or remove this gasket.</p>

Cleaning Recommendations

Surface Type	Cleaning Recommendation
<ul style="list-style-type: none">• Ceramic cooktop	<p>Do not use spray cleaners on the cooktop. See Cooktop Cleaning and Maintenance in the Care & Cleaning section.</p>
<ul style="list-style-type: none">• Stainless steel finish (some models)	<p>Clean heavier soils with hot, soapy water and a dishcloth. Rinse and dry using clean water and a cloth.</p> <p>Only use cleaners and polishes that are specifically manufactured for cleaning stainless steel. Always wipe in direction of metal grain to avoid damaging. Do not use cleaners with high concentrations of chlorides or chlorine. Do not use harsh scrubbing cleaners.</p> <p>Polish with a lint-free cloth. Always be sure to wipe excess cleaner/polish off from the metal surface as bluish stains may occur during future oven heating that cannot be removed.</p>

Cooktop maintenance

Consistent and proper cleaning is essential to maintaining your ceramic glass cooktop.

Prior to using your cooktop for the first time, apply some of the cooktop cleaner supplied with your new appliance. Buff with a **nonabrasive** cloth or no-scratch cleaning pad. This will make cleaning easier when soiled from cooking. The special cooktop cleaning cream leaves a protective finish on the glass to help prevent scratches and abrasions.

Cookware with rough or dirty bottoms can mark or scratch the cooktop surface. Even when clean, sliding cookware on the cooktop can cause metal markings to appear on the cooktop glass. These marks should be removed **immediately** after the cooktop has cooled using the supplied cooktop cleaning cream. Metal marks may eventually become permanent if not removed prior to using the cooktop again.

DO NOT:

- Use cookware with dirt or dirt build up on bottom; replace with clean cookware before using.
- Use your cooktop as a cutting board or work surface in the kitchen.
- Drop heavy or hard objects on the ceramic glass cooktop, they may cause it to crack.
- Slide anything metal or glass across the cooktop.

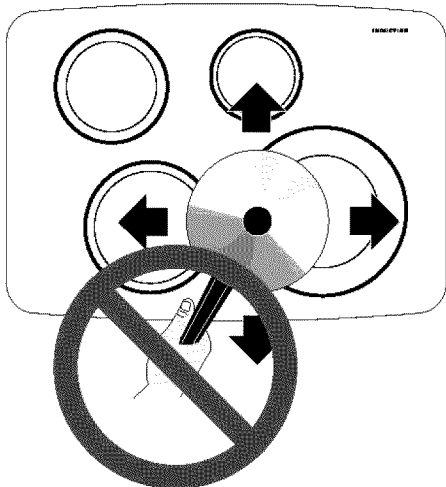

Cooktop cleaning

⚠ CAUTION

Before cleaning the cooktop, be sure the controls are turned to OFF and the cooktop is COOL.

For light to moderate soil:

Apply a few drops of the ceramic glass cooktop cleaner directly to the cooktop. Use a paper towel or use a **nonabrasive** plastic type no-scratch cleaning pad to clean the entire cooktop surface. Make sure the cooktop is cleaned thoroughly, leaving no residue.

For heavy, burned on soil:

Apply a few drops of the ceramic glass cooktop cleaner directly to the soiled area. Rub the soiled area using a **nonabrasive** plastic type no-scratch cleaning pad, applying pressure as needed. Do not use the pad you use to clean the cooktop for any other purpose.

If soils remain, carefully scrape soils with a metal razor blade scraper, holding scraper at a 30 degree angle to the surface as shown. Remove loosened soils with cooktop cleaning cream and buff surface clean.

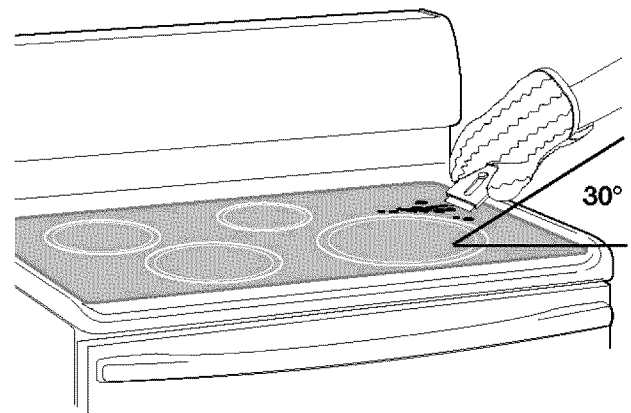

Cooktop cleaning

Plastic or foods with a high sugar content:

These types of soils need be removed immediately if spilled or melted onto the ceramic cooktop surface. Permanent damage (such as pitting of the cooktop surface) may occur if not removed **immediately**. After turning the surface elements OFF, use a razor blade scraper or a metal spatula with a mitt and scrape the soil from the hot surface (as illustrated). Allow the cooktop to cool, and use the same method for heavy or burned on soils.

Do not use the following on the cooktop:

- Do not use abrasive cleaners and scouring pads, such as metal and some nylon pads. They may scratch the cooktop, making it more difficult to clean.
- Do not use harsh cleaners, such as chlorine bleach, ammonia or oven cleaners, as they may etch or discolor the cooktop.
- Do not use dirty sponges, cloths or paper towels, as they can leave soil or lint on the cooktop which can burn and cause discoloration.



Special caution for aluminum use on the cooktop

Aluminum foil - Use of aluminum foil on a hot cooktop can damage the cooktop. Do not set down thin aluminum cooking utensils or allow aluminum foil to remain on the cooktop near hot cooking zones.

▶ IMPORTANT

Damage to the ceramic glass cooktop may occur if you use an abrasive type cleaning pad. Only use cleaning products that have been specifically designed for ceramic glass cooktops.

The oven door with Luxury-Hold™ hinges

CAUTION

To prevent possible burns, do not attempt to remove the oven door until the oven has completely cooled.

IMPORTANT

The oven door is heavy. Be careful when removing and lifting the door. Do not lift the oven door by the handle.

1. Fully open the oven door -*Fig. 1*-.
2. Unlock both oven door hinge locks by pulling them up and away from the oven frame until they stop (unlocked position) -*Figs. 2*-. If needed use a small flat-bladed screwdriver to assist with loosening the door hinge locks.
3. Firmly grasp both sides of oven door -*Fig. 3*-. Before completing this step, be prepared to hold the whole weight of the door while grasping the sides of the oven door with both hands. Hold midway down the oven door sides. Close the oven door to about 4 inches and continue closing beyond the door stop position. The oven door should release from the frame on its own. -*Fig. 3*-.
5. Carefully lift door away evenly, slightly up and out until both hinge arms are clear of the hinge slots in the oven frame -*Fig. 3*-. After door has been removed, be sure to lay the door flat with the inside of the door downward (never rest the oven door with any weight on the door handle).

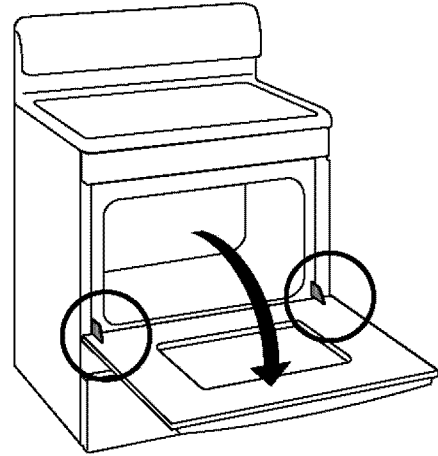

Fig. 1

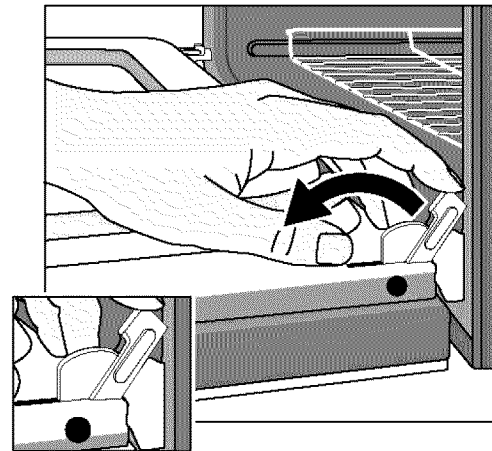

Fig. 2

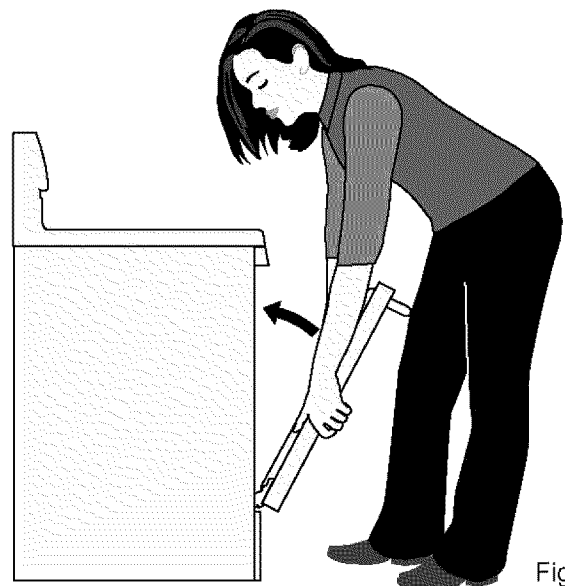

Fig. 3

The oven door with Luxury-Hold™ hinges

To replace the Lift-Off oven door

1. Firmly grasp the oven door along both sides just below the door handle. When positioning the door hinge arms with the door hinge slots in the oven frame, you may wish to use your knee to stabilize the door before attempting to insert the door hinge arms in the hinge slots -*Fig. 1*-.
2. Position the angle of the door to the door removal angle and carefully insert the door hinge arms fully and evenly into the door hinge slots. Carefully let the weight of the door transfer from your hands so that the oven now supports the oven door.
3. Open the oven door down to the fully open position -*Fig. 2*-.
4. With the door in the fully open position, push both oven door hinge locks toward the oven frame until they both are locked -*Fig. 3*-.
5. Close the oven door.

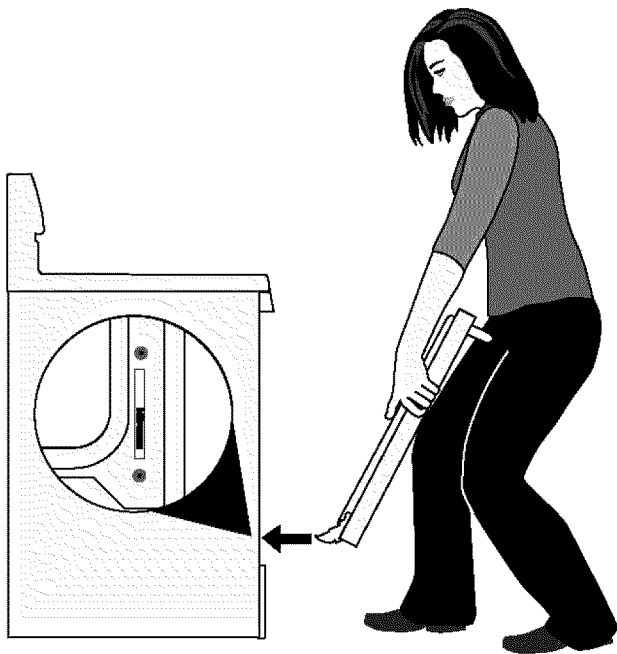

Fig. 1

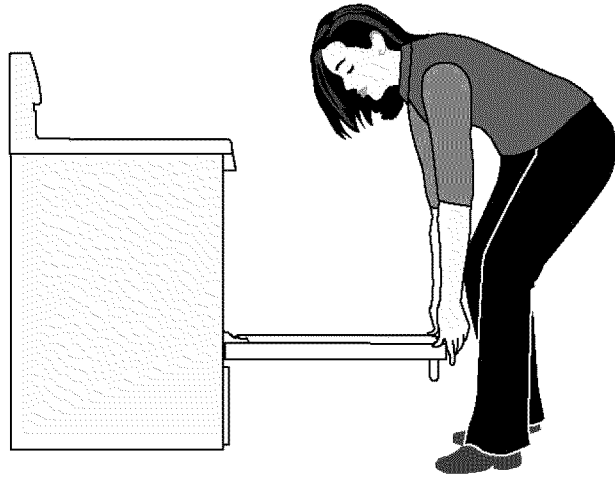

Fig. 2

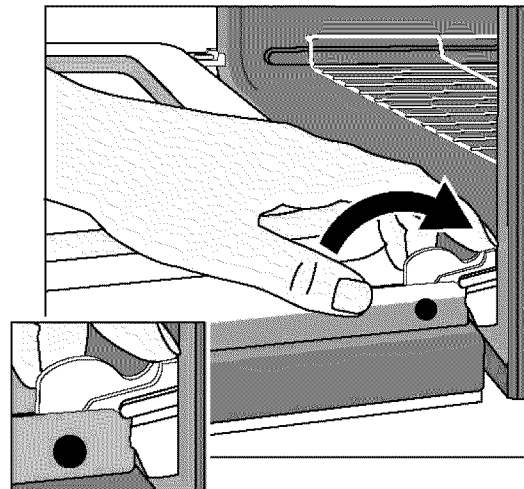

Fig. 3

Special door care instructions

IMPORTANT

Most oven doors contain glass that can break. Read the following recommendations:

- **Do not** close the oven door until all the interior oven racks are fully inserted and retracted to the back of the oven.
- Do not hit the glass with pots, pans, or any other object. The oven door glass may break or even break at a later time unexpectedly.
- Scratching, hitting, jarring or stressing the oven door glass may weaken its structure causing an increased risk of breakage at a later time.
- You may use a glass cleaner on the outside of the oven door glass. **Do not spray** or allow water or the cleaner to enter or drip down into the oven door vents. Spray cleaner on cloth first and then wipe the oven door clean.
- **Do not** use strong oven cleaners, powders or any harsh abrasive cleaning materials on the outside of the oven door or glass.
- **Never clean** the oven door gasket. The oven door gasket should always clean during the Self-clean cycle.

Changing upper oven lights

CAUTION

- Be sure the range is unplugged and all parts are **COOL** before replacing oven light. Wear a leather-faced glove for protection against possible broken glass or burns.

The upper oven light bulbs are located at the rear of the oven cavity and both are covered with a glass shield. The glass shield must be in place whenever the oven is in use.

Replacing the upper oven interior light bulbs:

1. Turn electrical power off at the main source or unplug the appliance.
2. Remove upper oven interior light shield as illustrated below.
3. Replace bulb with a new **T-4 type 40 Watt Halogen** appliance bulb. Please note: do not allow your fingers to touch the new bulb when replacing. This will shorten the life of the new bulb. Use a paper towel to cover the new bulb when installing.
4. Replace glass shield over bulb.
5. Turn power back on again at the main source (or plug the appliance back in).
6. The clock will then need to be reset.

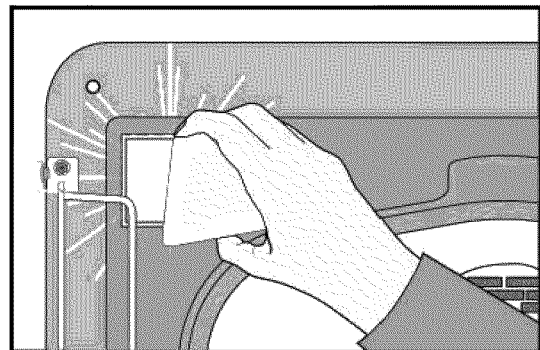

Changing lower oven light

Removing lower oven and replacing light

1. Before drawer removal, be sure to turn OFF the lower oven and let the drawer area cool completely.
2. Pull the drawer away from the oven. Using a phillips-head screwdriver remove the two drawer screws from the insides of the front oven drawer compartment -*Fig. 1-*.
3. With one hand hold the drawer front in place. Use your other hand to pull the glide away from the oven (See Fig. 2) until the glide hook disengages -*Fig. 3-*.
4. Repeat from step 3 above for the other side of the drawer.
5. With BOTH glide hooks disengaged, carefully lift the drawer up and away from the oven. Push both drawer glides into lower oven cavity.
6. Replace the lower oven light with a 40 Watt appliance light bulb -*Fig. 5-*.

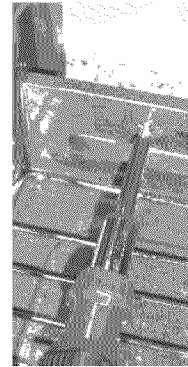

Fig. 1

Replacing lower oven

1. Pull both drawer glides and fully extend outward from lower oven cavity.
2. Carefully rest the drawer on top of both glides.
3. Adjust the drawer position on top of the rails until both of the drawer side slots are correctly engaged with the glide hooks -*Fig. 4-*.
4. Pull the drawer forward to line up the drawer with both screw holes in the glides. Using a phillips-head screwdriver replace the two screws removed from the inner drawer sides.
5. Replace drawer rack if removed.
6. Close lower oven drawer.

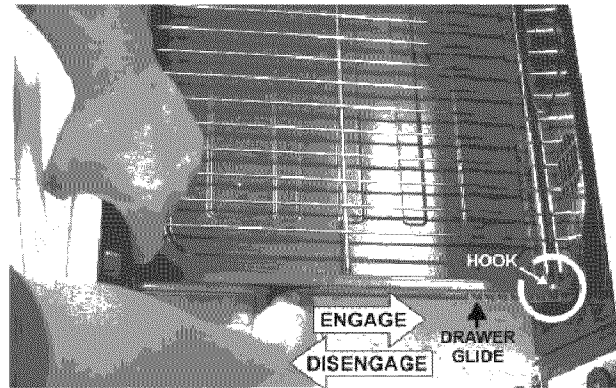
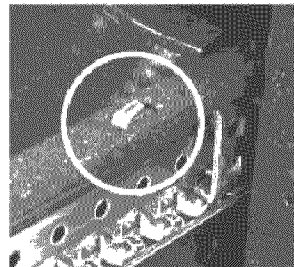
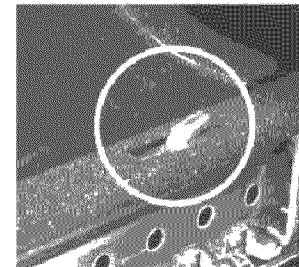

Fig. 2



Glide Hook Disengaged

Fig. 3



Glide Hook Engaged

Fig. 4

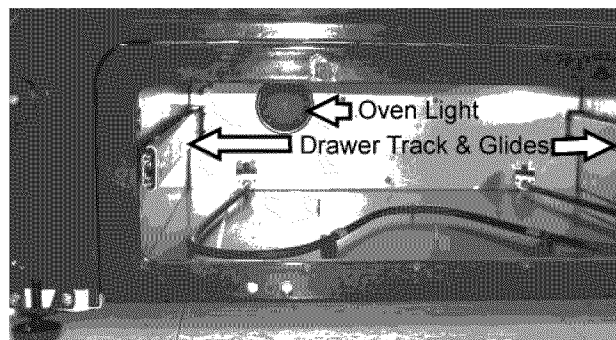

Fig. 5

62 Solutions to Common Problems

Before you call for service, review the following list. It may save you time & expense. The list includes common occurrences that are not the result of defective workmanship or materials in this appliance.

Before you call	
Problem	Solution
Poor baking results.	<ul style="list-style-type: none">• Many factors affect baking results. Make sure the proper oven rack position is used. Center food in the oven and space pans to allow air to circulate. Allow the oven to preheat to the set temperature before placing food in the oven. Try adjusting the recipe's recommended temperature or baking time. If you feel the oven is too hot or cool, see "Adjusting Oven Temperature" in the Setting Your Preferences section of this Use & Care Guide.
Entire appliance does not operate.	<ul style="list-style-type: none">• The time of day is not set. The time of day must first be set in order to operate the oven. See "Setting clock at power up" in the Getting Started section.• Make sure cord/plug is plugged correctly into outlet.• Service wiring is not complete. Contact your dealer, installing agent or authorized service agent.• Electrical power outage. Check house lights to be sure. Call your local electric company for service.
Oven portion of appliance does not operate.	<ul style="list-style-type: none">• The time of day is not set. The time of day must first be set in order to operate the oven. See "Setting clock at power up" in the Getting Started section.• Be sure the oven controls are set properly for the desired cooking feature. See Setting Oven Controls in this Use & Care Guide or read the instructions "Entire appliance does not operate" in this checklist.
Induction cooking zone does not heat.	<ul style="list-style-type: none">• Be sure to activate the correct cooking zone control that corresponds with the cookware placement on cooktop.• Be sure to use the correct cookware material type for induction cooking. Only use cookware specifically identified by the manufacturer for induction cooking. If you're not sure, use a magnet to test whether the cookware type will work. If a magnet sticks to the bottom of the cookware, the material type is correct for induction cooking.• Be sure to read about pan-sensing in the Induction Cooking section and correct any pan-sensing issues in the checklist provided.
Induction cooking zone seems too hot or not hot enough.	<ul style="list-style-type: none">• Incorrect surface control power level setting. Adjust the power level to correct.

Questions or for service call: 1-877-4ELECTROLUX(1-877-435-3287)

Before you call

Problem	Solution
Surface cooking zone does not heat evenly.	<ul style="list-style-type: none"> Lightweight or warped pans used. Use only flat, evenly balanced, medium or heavyweight quality cookware. Flat pans heat better than warped pans. Cookware materials and weight of the material affect heating. Heavy & medium-weight pans heat more evenly. Because lightweight pans heat unevenly, foods may burn easily.
Cooking zones do not glow red when heating cookware.	<ul style="list-style-type: none"> The induction cooking zones will not glow when they are heating. Induction cooking uses electromagnetic energy to induce heat directly to the cookware on the cooktop.
Oven control panel beeps & displays any F code error.	<ul style="list-style-type: none"> Oven control has detected a fault condition. Press CANCEL to clear the display & stop beeping. Try the bake or broil feature again. If the F code error repeats, remove power supply from appliance, wait 5 minutes and then repower the appliance and set clock for the time of day. Try the bake or broil feature again. If the fault recurs, record fault number and call for service.
Oven control panel beeps & cooktop control displays any E code error.	<ul style="list-style-type: none"> The cooktop control has detected a fault or error condition. If the E code error persists, turn off any active cooking zones. Remove power supply from appliance, wait 5 minutes and then repower the appliance and set clock for time of day. Try the cooktop setting again. If the error recurs, record E code error number and call for service.
Self-clean cycle will not start.	<ul style="list-style-type: none"> Oven racks not removed or oven control not set properly. Follow instructions under Self-cleaning.
Soil not completely removed after finishing self-cleaning cycle.	<ul style="list-style-type: none"> Self-cleaning cycle was interrupted. Follow steps under "Stopping or interrupting a self-cleaning cycle" under Self-Cleaning. Excessive spillovers on oven bottom. Remove before starting self-clean. Failure to clean bottom, front top of oven, frame of oven or door area outside oven seal. These areas are not in the self-cleaning area, but get hot enough to burn on residue. Clean these areas before the self-cleaning cycle is started. Burned-on residue can be cleaned with a stiff nylon brush and water or a nylon scrubber. Be careful not to damage the oven door gasket.

64 Solutions to Common Problems

Before you Call	
Problem	Solution
Oven smokes excessively during broiling.	<ul style="list-style-type: none">• Control not set properly. Follow broiling instructions under Setting Oven Controls.• Make sure oven door is opened to broil stop position.• Meat too close to the broil element. Reposition the broil rack to provide proper clearance between the meat & the element. Preheat the broil element for searing.• Meat not properly prepared. Remove excess fat from meat. Cut remaining fatty edges to prevent curling, but do not cut into lean.• Insert on broiler pan wrong side up & grease not draining. Always place grid on the broiler pan with ribs up & slots down to allow grease to drip into pan (some models).• Grease has built up on oven surfaces. Regular cleaning is necessary when broiling frequently. Old grease or food spatters cause excessive smoking.
Flames inside oven or smoking from oven vent.	<ul style="list-style-type: none">• Excessive spillovers in oven. For example this will happen for pie spillovers or large amounts of grease left on the oven bottom. Wipe up excessive spillovers before starting oven. If flames or excessive smoke are present see "About broiling" in the Setting Oven Controls section.
Appliance is not level.	<ul style="list-style-type: none">• Cabinets not square or are built in too tightly. Contact builder or installer to make appliance accessible.• Carpet interferes with appliance. Provide sufficient space so appliance can be lifted over carpet.
Cannot move appliance easily. Appliance must be accessible for service.	<ul style="list-style-type: none">• Be sure floor is level, strong & stable enough to adequately support range.• If floor is sagging or sloping, contact a carpenter to correct the situation.• Poor installation. Place oven rack in center of oven. Place a level on the oven rack. Adjust leveling legs at base of appliance until the oven rack is level.• Kitchen cabinet alignment may make range appear not level. Be sure cabinets are square & have sufficient room for appliance clearance.

Before you Call

Problem	Solution
Convection fan does not rotate.	<ul style="list-style-type: none">• Oven door is open. Convection fan will turn off if oven door is opened when Convection is active. Close oven door.
Oven light does not work.	<ul style="list-style-type: none">• Be sure light bulb is securely installed.• Replace bulb. See "Changing upper or lower oven lights" sections in this Use & Care Guide.
Scratches or abrasions on cooktop surface.	<ul style="list-style-type: none">• Coarse particles such as salt or sand between cooktop and utensils can cause scratches. Be sure cooktop surface and bottoms of utensils are clean before usage. Small scratches do not affect cooking and will become less visible with time.• Cleaning materials not recommended for ceramic-glass cooktop have been used. See "Cooktop Cleaning and Maintenance" in the Care and Cleaning section of this Use & Care Guide.• Cookware with rough bottom was used. Only use smooth, flat-bottomed quality cookware.
Metal marks on cooktop surface.	<ul style="list-style-type: none">• Sliding or scraping of metal utensils on cooktop surface. Do not slide metal utensils on cooktop surface. Use a ceramic-glass cooktop cleaner to remove the marks. See "Cooktop Cleaning and Maintenance" in the Care and Cleaning section.
Brown streaks or specks on cooktop surface.	<ul style="list-style-type: none">• Boilovers are cooked onto surface. Use razor blade scraper to remove soil. See "Cooktop Cleaning and Maintenance" in the Care and Cleaning section.
Areas of discoloration with metallic sheen on cooktop surface.	<ul style="list-style-type: none">• Mineral deposits from water and food. Remove using a ceramic-glass cooktop cleaner. Only use quality cookware with clean, dry bottoms.

66 Display Abbreviations

List of displayed abbreviations

See the chart below for common abbreviations that you may see while using your appliance.

Abbreviations Chart			
Message	Message explanation	Oven control location	Cooktop control location
--	Cooktop lock		X
CLn	Self clean	X	
CLO	Setting the clock	X	
dEF	Defrost	X	
d-O	Door open	X	
E11*			X
End	End of cycle	X	
F10*	Fault code error	X	
HE	Hot element	X	X
Hi	Hi setting	X	X
Hot	Hot oven	X	
Lo	Lo setting	X	X
Loc	Control lock	X	
Pb	Power Boost		X
SAb	Sabbath mode	X	
--	Sabbath mode		X
Sd	Demo mode	X	
SF	Sabbath mode failure	X	
--	Sabbath mode failure		X
CF	Check food	X	

*Example of an error or fault code.

The numbers following any E or F code may be different than those provided in the example shown above. Make a note of E or F code and the number following. This code will help your servicer identify the problem and repair your appliance.

Your appliance is covered by a one year limited warranty. For one year from your original date of purchase, Electrolux will repair or replace any parts of this appliance that prove to be defective in materials or workmanship when such appliance is installed, used, and maintained in accordance with the provided instructions. In addition, the glass cooktop or radiant surface element of your appliance (excluding built-in and free-standing range appliances) is covered by a two through five year limited warranty. During the 2nd through 5th years from your original date of purchase, Electrolux will provide a replacement glass cooktop or radiant surface element for your appliance which has proven to be defective in materials or workmanship when such appliance is installed, used, and maintained in accordance with the provided instructions.

Exclusions

This warranty does not cover the following:

1. Products with original serial numbers that have been removed, altered or cannot be readily determined.
2. Product that has been transferred from its original owner to another party or removed outside the USA or Canada.
3. Rust on the interior or exterior of the unit.
4. Products purchased "as-is" are not covered by this warranty.
5. Products used in a commercial setting.
6. Service calls which do not involve malfunction or defects in materials or workmanship, or for appliances not in ordinary household use or used other than in accordance with the provided instructions.
7. Service calls to correct the installation of your appliance or to instruct you how to use your appliance.
8. Expenses for making the appliance accessible for servicing, such as removal of trim, cupboards, shelves, etc., which are not a part of the appliance when it is shipped from the factory.
9. Service calls to repair or replace appliance light bulbs, air filters, water filters, other consumables, or knobs, handles, or other cosmetic parts.
10. Labor or in-home service costs during the additional limited warranty periods beyond the first year from your original date of purchase.
11. Pickup and delivery costs; your appliance is designed to be repaired in the home.
12. Surcharges including, but not limited to, any after hour, weekend, or holiday service calls, tolls, ferry trip charges, or mileage expense for service calls to remote areas, including the state of Alaska.
13. Damages to the finish of appliance or home incurred during transportation or installation, including but not limited to floors, cabinets, walls, etc.
14. Damages caused by: services performed by unauthorized service companies; use of parts other than genuine Electrolux parts or parts obtained from persons other than authorized service companies; or external causes such as abuse, misuse, inadequate power supply, accidents, fires, or acts of God.

DISCLAIMER OF IMPLIED WARRANTIES; LIMITATION OF REMEDIES

CUSTOMER'S SOLE AND EXCLUSIVE REMEDY UNDER THIS LIMITED WARRANTY SHALL BE REPAIR OR REPLACEMENT AS PROVIDED HEREIN. **CLAIMS BASED ON IMPLIED WARRANTIES, INCLUDING WARRANTIES OF MERCHANTABILITY OR FITNESS FOR A PARTICULAR PURPOSE, ARE LIMITED TO ONE YEAR OR THE SHORTEST PERIOD ALLOWED BY LAW, BUT NOT LESS THAN ONE YEAR.** ELECTROLUX SHALL NOT BE LIABLE FOR CONSEQUENTIAL OR INCIDENTAL DAMAGES SUCH AS PROPERTY DAMAGE AND INCIDENTAL EXPENSES RESULTING FROM ANY BREACH OF THIS WRITTEN LIMITED WARRANTY OR ANY IMPLIED WARRANTY. SOME STATES AND PROVINCES DO NOT ALLOW THE EXCLUSION OR LIMITATION OF INCIDENTAL OR CONSEQUENTIAL DAMAGES, OR LIMITATIONS ON THE DURATION OF IMPLIED WARRANTIES, SO THESE LIMITATIONS OR EXCLUSIONS MAY NOT APPLY TO YOU. THIS WRITTEN WARRANTY GIVES YOU SPECIFIC LEGAL RIGHTS. YOU MAY ALSO HAVE OTHER RIGHTS THAT VARY FROM STATE TO STATE.

If You Need Service

Keep your receipt, delivery slip, or some other appropriate payment record to establish the warranty period should service be required. If service is performed, it is in your best interest to obtain and keep all receipts. Service under this warranty must be obtained by contacting Electrolux at the addresses or phone numbers below.

This warranty only applies in the USA, Puerto Rico and Canada. In the USA and Puerto Rico, your appliance is warranted by Electrolux Major Appliances North America, a division of Electrolux Home Products, Inc. In Canada, your appliance is warranted by Electrolux Canada Corp. Electrolux authorizes no person to change or add to any obligations under this warranty. Obligations for service and parts under this warranty must be performed by Electrolux or an authorized service company. Product features or specifications as described or illustrated are subject to change without notice.

USA

1-877-435-3287

Electrolux Major Appliances North America
10200 David Taylor Drive
Charlotte, NC 28262

Canada

1-800-265-8352

Electrolux Canada Corp.
5855 Terry Fox Way
Mississauga, Ontario, Canada L5V 3E4

 **Electrolux**