

# SHARP®

## SOUND BAR SYSTEM

MODEL

# HT-SB500

OPERATION MANUAL



**Note:**

This product is recommended for flat panel TV (LCD and plasma).

Thank you for purchasing this SHARP product. To obtain the best performance from this product, please read this manual carefully. It will guide you in operating your SHARP product.

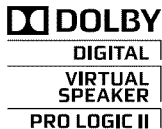
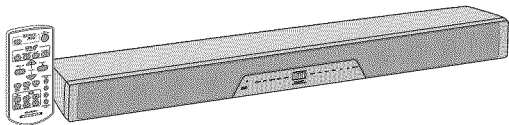

**SRS** is a trademark of SRS Labs, Inc.  
**TruSurround HD**

TruSurround HD technology is incorporated under license from SRS Labs, Inc.

SRS TruSurround HD™ creates an immersive, feature-rich surround sound experience from two speakers, complete with rich bass, high frequency detail and clear dialog.

# SPECIAL NOTES



**CAUTION**  
**RISK OF ELECTRIC SHOCK**  
**DO NOT OPEN**



**CAUTION: TO REDUCE THE RISK OF ELECTRIC SHOCK, DO NOT REMOVE COVER (OR BACK). NO USER-SERVICEABLE PARTS INSIDE. REFER SERVICING TO QUALIFIED SERVICE PERSONNEL.**

**Explanation of Graphical Symbols:**



The lightning flash with arrowhead symbol, within an equilateral triangle, is intended to alert the user to the presence of uninsulated "dangerous voltage" within the product's enclosure that may be of sufficient magnitude to constitute a risk of electric shock to persons.



The exclamation point within an equilateral triangle is intended to alert the user to the presence of important operating and maintenance (servicing) instructions in the literature accompanying the appliance.

**WARNING: TO REDUCE THE RISK OF FIRE OR ELECTRIC SHOCK, DO NOT EXPOSE THIS APPLIANCE TO RAIN OR MOISTURE.**

## FOR YOUR RECORDS

For your assistance in reporting this unit in case of loss or theft, please record below the model number and serial number which are located on the bottom of the unit.  
Please retain this information.

Model number .....

Serial number .....

Date of purchase .....

Place of purchase .....

## NOTE

This equipment has been tested and found to comply with the limits for a Class B digital device, pursuant to Part 15 of the FCC Rules. These limits are designed to provide reasonable protection against harmful interference in a residential installation. This equipment generates, uses, and can radiate radio frequency energy and, if not installed and used in accordance with the instructions, may cause harmful interference to radio communications. However, there is no guarantee that interference will not occur in a particular installation. If this equipment does cause harmful interference to radio or television reception, which can be determined by turning the equipment off and on, the user is encouraged to try to correct the interference by one or more of the following measures:

- Reorient or relocate the receiving antenna.
- Increase the separation between the equipment and receiver.
- Connect the equipment into an outlet on a circuit different from that to which the receiver is connected.
- Consult the dealer or an experienced radio/TV technician for help.

## WARNING

FCC Regulations state that any unauthorized changes or modifications to this equipment not expressly approved by the manufacturer could void the user's authority to operate this equipment.

# IMPORTANT SAFETY INSTRUCTIONS

HT-SB500

Electricity is used to perform many useful functions, but it can also cause personal injuries and property damage if improperly handled. This product has been engineered and manufactured with the highest priority on safety. However, improper use can result in electric shock and/or fire. In order to prevent potential danger, please observe the following instructions when installing, operating and cleaning the product. To ensure your safety and prolong the service life of this product, please read the following precautions carefully before use.

- 1) Read these instructions.
- 2) Keep these instructions.
- 3) Heed all warnings.
- 4) Follow all instructions.
- 5) Do not use this apparatus near water.
- 6) Clean only with dry cloth.
- 7) Do not block any ventilation openings. Install in accordance with the manufacturer's instructions.
- 8) Do not install near any heat sources such as radiators, heat registers, stoves, or other apparatus (including amplifiers) that produce heat.
- 9) Do not defeat the safety purpose of the polarized or grounding-type plug. A polarized plug has two blades with one wider than the other. A grounding type plug has two blades and a third grounding prong. The wide blade or the third prong are provided for your safety. If the provided plug does not fit into your outlet, consult an electrician for replacement of the obsolete outlet.
- 10) Protect the power cord from being walked on or pinched particularly at plugs, convenience receptacles, and the point where they exit from the apparatus.
- 11) Only use attachments/accessories specified by the manufacturer.

- 12) Use only with the cart, stand, tripod, bracket, or table specified by the manufacturer, or sold with the apparatus. When a cart is used, use caution when moving the cart/apparatus combination to avoid injury from tip-over.
- 13) Unplug this apparatus during lightning storms or when unused for long periods of time.
- 14) Refer all servicing to qualified service personnel. Servicing is required when the apparatus has been damaged in any way, such as power-supply cord or plug is damaged, liquid has been spilled or objects have fallen into the apparatus, the apparatus has been exposed to rain or moisture, does not operate normally, or has been dropped.

## Additional Safety Information









- 15) Power Sources - This product should be operated only from the type of power source indicated on the marking label. If you are not sure of the type of power supply to your home, consult your product dealer or local power company. For product intended to operate from battery power, or other sources, refer to the operating instructions.
- 16) Overloading - Do not overload wall outlets, extension cords, or integral convenience receptacles as this can result in a risk of fire or electric shock.
- 17) Object and Liquid Entry - Never push objects of any kind into this product through openings as they may touch dangerous voltage points or short-out parts that could result in a fire or electric shock. Never spill liquid of any kind on the product.

## IMPORTANT SAFETY INSTRUCTIONS (continued)

- 18) **Damage Requiring Service** - Unplug this product from the wall outlet and refer servicing to qualified service personnel under the following conditions:
- When the AC cord or plug is damaged,
  - If liquid has been spilled, or objects have fallen into the product,
  - If the product has been exposed to rain or water,
  - If the product does not operate normally by following the operating instructions. Adjust only those controls that are covered by the operating instructions as an improper adjustment of other controls may result in damage and will often require extensive work by a qualified technician to restore the product to its normal operation,
  - If the product has been dropped or damaged in any way, and
  - When the product exhibits a distinct change in performance - this indicates a need for service.
- 19) **Replacement Parts** - When replacement parts are required, be sure the service technician has used replacement parts specified by the manufacturer or have the same characteristics as the original part. Unauthorized substitutions may result in fire, electric shock, or other hazards.
- 20) **Safety Check** - Upon completion of any service or repairs to this product, ask the service technician to perform safety checks to determine that the product is in proper operating condition.
- 21) **Wall or ceiling mounting** - When mounting the product on a wall or ceiling, be sure to install the product according to the method recommended by the manufacturer.
- 22) **Power Lines** - An outside antenna system should not be located in the vicinity of overhead power lines or other electric light or power circuits, or where it can fall into such power lines or circuits. When installing an outside antenna system, extreme care should be taken to keep from touching such power lines or circuits as contact with them might be fatal.
- 23) **Outdoor Antenna Grounding** - If an outside antenna or cable system is connected to the product, be sure the antenna or cable system is grounded so as to provide some protection against voltage surges and built-up static charges. Article 810 of the National Electrical Code, ANSI/NFPA 70, provides information with regards to proper grounding of the mast and supporting structure, grounding of the lead-in wire to an antenna discharge unit, connection to grounding electrodes, and requirements for the grounding electrode.
- 24) **Protective Attachment Plug** - The product is equipped with an attachment plug having overload protection. This is a safety feature. See Instruction Manual for replacement or resetting of protective device. If replacement of the plug is required, be sure the service technician has used a replacement plug specified by the manufacturer that has the same overload protection as the original plug.
- 25) **Stand** - Do not place the product on an unstable cart, stand, tripod or table. Placing the product on an unstable base can cause the product to fall, resulting in serious personal injuries as well as damage to the product. Use only a cart, stand, tripod, bracket or table recommended by the manufacturer or sold with the product. When mounting the product on a wall, be sure to follow the manufacturer's instructions. Use only the mounting hardware recommended by the manufacturer.

## Accessories

Please confirm that only the following accessories are included.

 Remote control x 1 (RRMCGA200AWSA)	 RCA cable (2 pins - 2 pins) x 1 (QCNWGA041AWPZ)
 Spike x 4 (length: 25 mm) (GLEGMA005AWSA)	 Foot cushion x 4 (PCUSSA118AWZZ)
 AC power lead x 1 (QACDA005AWZZ)	
 AC/DC adaptor x 1 (RADPAA061AWZZ)	 Wall mount angle x 2 (LANGKA167AW01)
 Nut (Spike + Nut) x 4 (length: 30 mm) (GLEGMA004AWSA)	 Pattern paper x 1 (TCAUHA023AWZZ)

### Note:

The AC/DC adaptor may be different from the one in the drawing.

## ENERGY STAR® Program Information



Products that have earned the ENERGY STAR® are designed to protect the environment through superior energy efficiency.

ENERGY STAR® is a U.S. registered mark.

## Contents

	Page
■ General Information	
Precautions . . . . .	6
Controls and indicators . . . . .	7 - 9
■ Preparation for Use	
Speaker preparation . . . . .	10 - 12
Placing the speaker . . . . .	13
Falling prevention . . . . .	14
Speaker connections to TVs . . . . .	14 - 16
AC power connection . . . . .	17
Remote control . . . . .	18
■ Basic Operation	
General control . . . . .	19 - 21
■ References	
Troubleshooting chart . . . . .	22
Maintenance . . . . .	23
Error indicators and warnings . . . . .	24
Specifications . . . . .	25
CONSUMER LIMITED WARRANTY . . . . .	Back cover

## Precautions

### ■ General

- Please ensure that the equipment is positioned in a well-ventilated area and ensure that there is at least 4" (10 cm) of free space along the sides and top of the equipment.

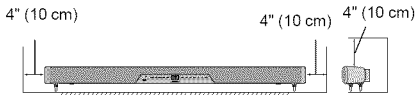

- Use the speaker on a firm, level surface free from vibration.
- Keep the speaker away from direct sunlight, strong magnetic fields, excessive dust, humidity and electronic/electrical equipment (home computers, facsimiles, etc.) which generate electrical noise.
- Do not place anything on top of the speaker.
- Do not expose the speaker to moisture, to temperatures higher than 140°F (60°C) or to extremely low temperatures.
- If your system does not work properly, disconnect the AC power cord from the AC outlet. Plug the AC power cord back in, and then turn on your system.
- In case of an electrical storm, unplug the speaker for safety.
- Hold the AC power plug by the head when removing it from the AC outlet, as pulling the cord can damage internal wires.
- The AC power plug is used as a disconnect device and shall always remain readily operable.
- **Do not remove the outer cover, as this may result in electric shock. Refer internal service to your local SHARP service facility.**
- This speaker should only be used within the range of 41°F - 95°F (5°C - 35°C).
- Do not use an external power supply other than the 12V DC supplied with this unit as it may be damaged.
- SHARP is not responsible for damage due to improper use. Refer All servicing to a SHARP authorised service centre.

### Warning:

- The voltage used must be the same as that specified on this speaker. Using this product with a higher voltage other than that which is specified is dangerous and may result in a fire or other type of accident causing damage. SHARP will not be held responsible for any damage resulting from use of this speaker with a voltage other than that which is specified.
- The supplied AC/DC adaptor contains no user serviceable parts. Never remove covers unless qualified to do so. It contains dangerous voltages, always remove mains plug from the main outlet jack before any service operation or when not in use for a long period.
- The AC/DC adaptor supplied with the HT-SB500 must not be used with other equipment.
- Never use an AC/DC adaptor other than the one specified. Otherwise, problem or serious hazards may be created.

### ■ Volume control

The sound level at a given volume setting depends on speaker efficiency, location, and various other factors. It is advisable to avoid exposure to high volume levels, which occurs while turning the speaker on with the volume control setting up high, or while continually listening at high volumes.

### ■ Precaution in using on the touch panel

- Do not use rough material to wipe the touch panel.
- Do not press the pad too hard, it can damage the touch sensor.

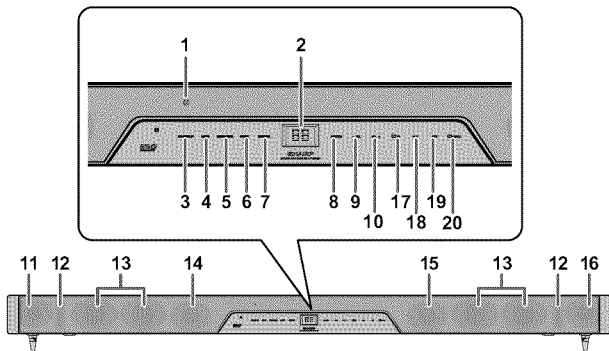

## ■ Front Panel

	Reference page		Reference page
1. Remote Sensor	18	11. Left Front Speaker	
2. Information Display	19	12. Bass Reflex Duct	
3. On/Stand-by Pad/Indicator	19	13. Subwoofers	
4. News Pad/Indicator	19	14. Left Center Speaker	
5. Cinema/Game Pad/Indicator	19	15. Right Center Speaker	
6. Sport Pad/Indicator	19	16. Right Front Speaker	
7. Standard Pad/Indicator	19	17. Dolby Virtual Speaker Pad/Indicator	20
8. Function Pad/Indicator	21	18. Dolby Prologic II Indicator	20
9. Volume Down Pad/Indicator	19	19. DTS Indicator	20
10. Volume Up Pad/Indicator	19	20. Dolby Digital Indicator	20

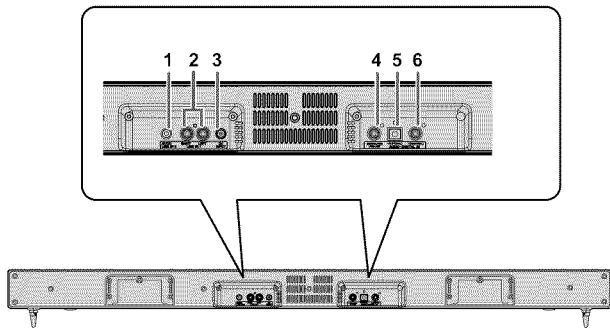

## ■ Rear Panel

### Reference page

- |   |    |
|---|----|
| 1. Audio Line In 2 Jack .....             | 15 |
| 2. Line In 1 Jacks .....                  | 15 |
| 3. DC Input Jack .....                    | 17 |
| 4. Subwoofer Pre-Out Jack .....           | 13 |
| 5. Optical Digital Audio Input Jack ..... | 16 |
| 6. Coaxial Digital Audio Input Jack ..... | 16 |



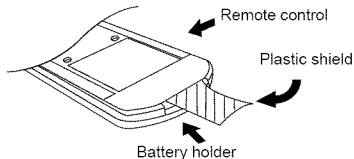
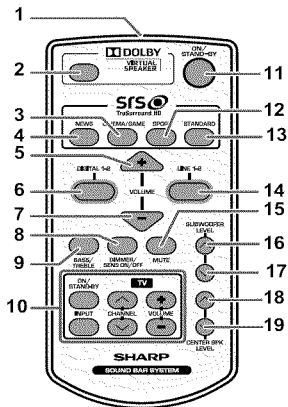





**Note:**  
Before using remote control, please remove plastic shield at battery holder.

## Remote Control

Reference page

1. Remote Control Transmitter	14
2. Dolby Virtual Speaker Button	16
3. Cinema/Game Button	15
4. News Button	15
5. Volume Up Button	15
6. Digital 1-2 Button	17
7. Volume Down Button	15
8. Dimmer/Sens On/Off Button	15
9. Bass/Treble Button	17
10. TV Operation Buttons	5
11. On/Stand-by Button	15
12. Sport Button	15
13. Standard Button	15
14. Line 1-2 Button	17
15. Mute Button	15
16. Subwoofer Level Up Button	17
17. Subwoofer Level Down Button	17
18. Center Speaker Level Up Button	17
19. Center Speaker Level Down Button	17

### TV Operation Buttons (Only SHARP TV):

On/Stand-by Button 	Sets the TV power to "ON" or "STANDBY".	Input Select Button (TV) 	Press the button to switch the input source.
Volume Up and Down Buttons 	Turn up/down the TV volume.	Channel Up and Down Buttons 	Switch up/down the TV channels.

### Notes:

- Some models of SHARP TV may not be operable.
- SHARP TV remote control will not work with HT-SB500 system.

## Speaker preparation

**Make sure to unplug the AC power cord before installing the speaker or changing the position.**

Select from three installation methods according to the preferred position.

### Using spikes

You may choose from the two different spike lengths provided: 25 mm and 30 mm.

Nuts (secured on 30 mm spikes) must be used when installing either the 25 mm or 30 mm spikes.

The speaker can be levelled by adjusting the spikes and nuts.

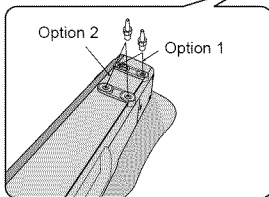
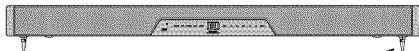

**Tighten all spikes as shown**

### Notes:

- Option 1 or option 2 indicates spike positions based on LCD TV stand.
- When attaching the spikes, place the speaker on a cushion or soft cloth to avoid damage.

### Caution:

When using these spikes on glossy or slippery table such as on glass top, stick foot cushions at the bottom of the spikes to avoid slippage.

### Using foot cushions

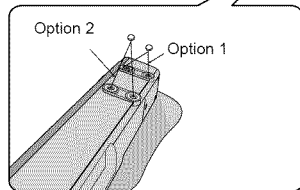

**Attach foot cushions as shown**

### Note:

Option 1 or option 2 foot cushion positions based on LCD TV stand.

## Speaker preparation (continued)

HT-SB500

### To mount the speaker on the wall

#### Caution:

- Be very careful to prevent the speaker [4.84 lbs. (2.2 kg)] from falling when mounting on the wall.
- Before mounting, check the wall strength. (Do not put on the veneer plaster or whitewashed wall. The speaker may fall.) If unsure, consult a qualified service technician.
- Mounting screws are not supplied. Use appropriate ones.
- Check all wall mount angle screws for looseness.
- Select a good location. If not, accidents may occur or the speaker may get damaged.
- **SHARP is not responsible for accidents resulting from improper installation.**

#### ■ Driving screws

SHARP designed the speakers so you may hang them on the wall. Use proper screws (not supplied). See below for size and type.

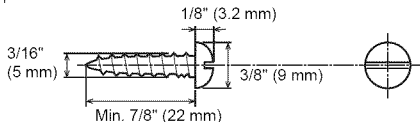

#### ■ Wall mount angle fixed to the wall (Horizontal position)

- 1 Fix the pattern paper to the wall in horizontal position as below.

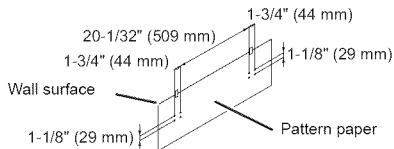

- 2 Make a hole on the wall following the screw point marks on the pattern paper by using a drill.

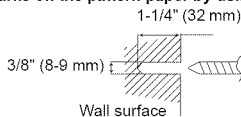

- 3 Fix a wall mount plug into the hole using a hammer, until it is flush with the wall surface.

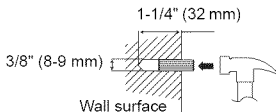

(Continued to the next page)

- 4** Screw the wall mount angle to the wall as shown in the illustration. (Total screw is 8 pieces)

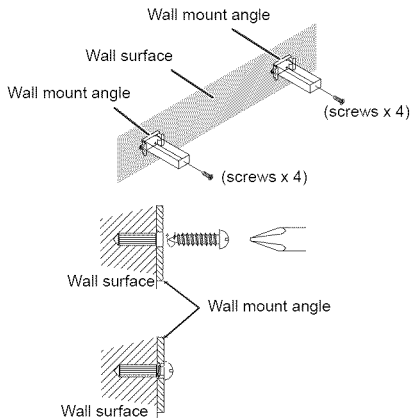

**Note:**

Make sure all screws are fully tightened. (screws are not supplied)

■ **Installing the speaker**

- 1** Align the wall mount slot at the speaker to the wall mount angle.
- 2** Slot the speaker into the wall mount angle.
- 3** Fix them securely.

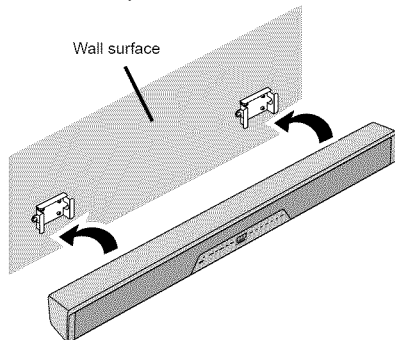

## Placing the speaker

Installation image:

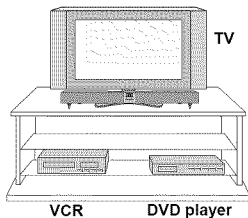

Place the speaker as shown.

### Notes:

- As the sound from the speaker is omni-directional, you can place the speaker anywhere you like. However, it is recommended to place it as close to the TV as possible.
- The front panel of the speaker is not removable.

### Caution:

- Do not change the installation direction when the speaker is turned on.
- Do not stand or sit on the speaker as you may be injured.

### ■ Using other subwoofer

You can connect a subwoofer with an amplifier to the SUBWOOFER PRE-OUT jack.

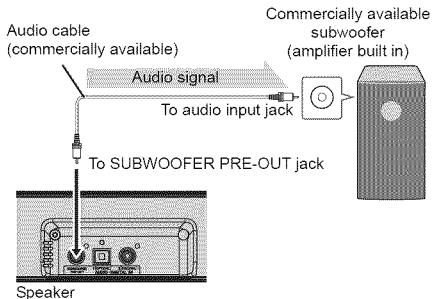

### Note:

No sound is heard from the subwoofer without a built-in amplifier.

## Falling prevention

Safety wires (not supplied) are useful to prevent the speaker from falling off the table.

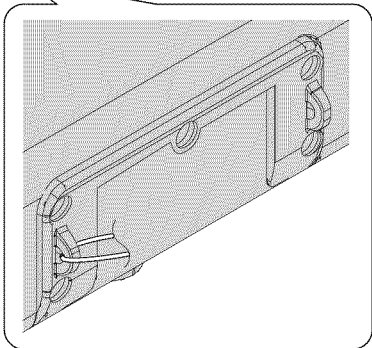
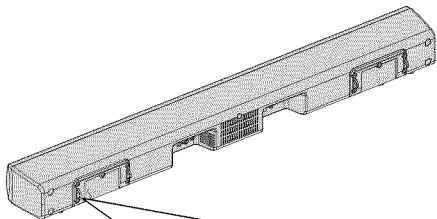

Loop the safety wires (not supplied) into each hole as shown and tie the safety wires to the LCD TV stand.

## Speaker connections to TVs

### Caution:

Turn off all other equipment before making any connections.

### Tuner receiving for other audio system

- Placing the aerial near the speaker AC power cord may cause noise pick up. Place the aerial away from the speaker for better reception.

### Notes:

- To connect to TV, use either LINE IN 1 jacks or AUDIO LINE IN 2 jack only.
- Refer the operation manual of the equipment to be connected.
- Fully insert the plugs to avoid fuzzy pictures or noises.

## Speaker connections to TVs (continued)

HT-SB500

### ■ Connecting to a TV

If the TV/monitor has an audio output, connect it to the LINE IN 1 jacks on the rear of the speaker.

#### To select LINE IN 1 function:

- On speaker: Press FUNCTION button repeatedly until "L1" is displayed.
- On remote control: Press LINE 1-2 button repeatedly until "L1" is displayed.

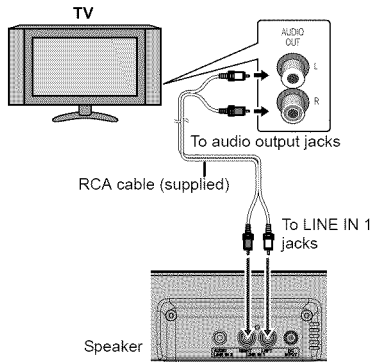

### ■ Connecting to a TV (with Headphone jack)

If the TV/monitor has headphone jack, connect it to the LINE IN 2 jack on the rear of the speaker.

#### To select LINE IN 2 function:

- On speaker: Press FUNCTION button repeatedly until "L2" is displayed.
- On remote control: Press LINE 1-2 button repeatedly until "L2" is displayed.

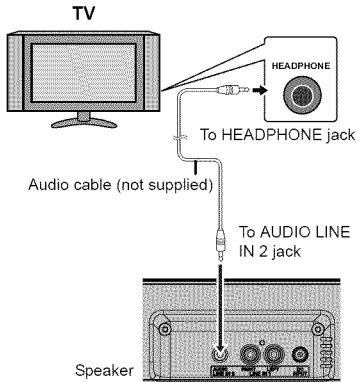

#### Notes:

- If the TV volume is continuously in low level, the speaker will automatically power off. Increase the TV output volume to enjoy the sound from the speaker.
- If the speaker volume is continuously in very high level, the speaker will mute and recover after several seconds.
- The information display on the sound bar system will not display anything when increasing or decreasing the volume level.

### ■ Connecting a digital tuner, etc.

Connect to the digital tuner, etc. using an optical digital audio cable or a coaxial digital audio cable.

To select **DIGITAL 1 (optical input)** or **DIGITAL 2 (digital input)** function:

- On speaker: Press **FUNCTION** button repeatedly until "D1" or "D2" is displayed.
- On remote control: Press **DIGITAL 1 - 2** button repeatedly to select "D1" or "D2".

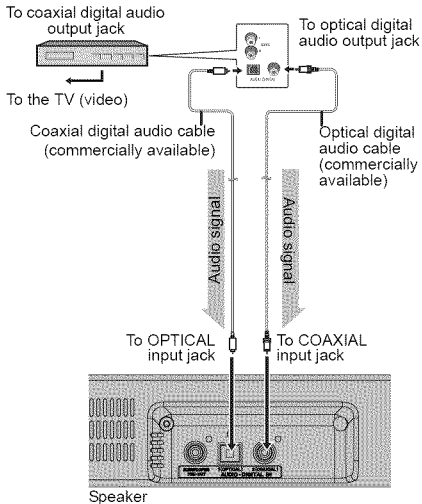

#### Note:

When connecting with an optical digital cable, set the digital output of the digital tuner to PCM. Refer to the operation manual of the digital tuner.



## AC power connection

HT-SB500

### ■ Using with the AC/DC adaptor

- 1 Plug the AC power cord into the AC/DC adaptor.
- 2 Plug the AC/DC adaptor cable into the DC IN jack on the speaker.
- 3 Plug the AC power cord into a AC outlet. The **STANDBY** indicator will turn **ORANGE** when AC power is applied. The power indicator will turn **GREEN** when the system in "ON".

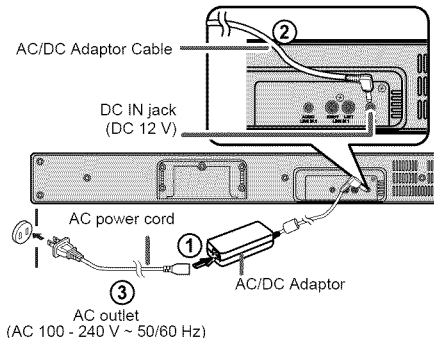

#### Notes:

- Unplug the AC/DC adaptor from the AC outlet if the speaker will not be used for a long period of time.
- Use only the supplied AC/DC adaptor. Using other AC/DC adaptor may cause an electric shock or fire.

## Remote control

### ■ Battery installation

- 1 Insert pin into the hole as shown and pull to open the battery holder.

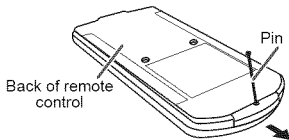

- 2 Remove the old battery from the battery holder, insert the new battery and then slide the battery holder back into the remote control.

Battery holder

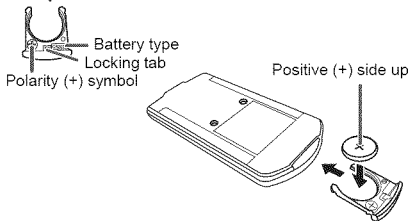

### Precautions for battery use:

- Remove the battery if the speaker will not be used for a long period of time. This will prevent potential damage due to battery leakage.

### Caution:

- Do not use rechargeable battery (nickel-cadmium battery, etc.).
- Danger of explosion if battery is incorrectly replaced.
- Replace only with the same or equivalent type.
- Batteries (battery pack or batteries installed) shall not be exposed to excessive heat such as sunshine, fire or the like.
- Installing the battery incorrectly may cause the speaker to malfunction.

### Notes concerning use:

- Replace the battery if the operating distance is reduced or if the operation becomes erratic. Purchase "CR 2025", coin lithium battery.
- Periodically clean the transmitter on the remote control and the sensor on the speaker with a soft cloth.
- Exposing the sensor on the speaker to strong light may interfere with operation. Change the lighting or the direction of the speaker if this occurs.
- Keep the remote control away from moisture, heat, shock, and vibrations.

### ■ Test of the remote control

Point the remote control directly at the remote sensor on the speaker.

The remote control can be used within the range shown below:

Press the ON/STAND-BY button. Does the power turn on? Now, you can enjoy your system.

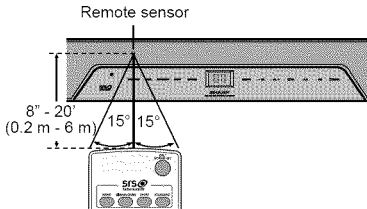

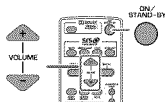
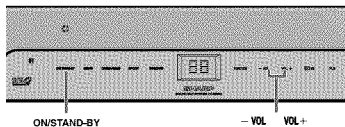

## ■ To turn the power on

Press the ON/STAND-BY button on the remote control or touch anywhere on the display panel. All the indicators will be displayed to indicate pad positions.

- The power indicator turns green. If the power does not turn on, check whether the power cord is plugged in properly.

## To set the speaker to stand-by mode:

- Press the ON/STAND-BY button again on the remote control or touch ON/STAND-BY pad on the speaker. The STAND-BY indicator turns orange.

## ■ Display brightness control

Press the DIMMER ON/OFF button to adjust the brightness of the display and sound mode indicator.

Sound mode indicator and display bright. Display will off after 5 seconds without any button/pad operation.



Sound mode indicator and display dim. Display will off after 5 seconds without any button/pad operation.

## ■ Volume auto fade-in

If you turn off and on the speaker with the volume set to 40 or higher, the volume starts at 20 and fades in to the last set level.

## ■ Volume control

### Speaker operation:

Touch volume up pad to increase the volume and touch volume down pad to decrease the volume.

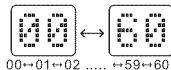

### Remote control operation:

Press the VOLUME + button to increase the volume and the VOLUME - button to decrease the volume.

## ■ Muting

The volume is muted temporarily when pressing the MUTE button on the remote control. Press again to restore the volume.



## ■ Preset sound mode

### Speaker operation:

Touch a desired sound mode on the speaker.

### Remote control operation:

Press a desired sound mode on the remote control.

NEWS	TruSurround HD on for news
CINEMA/GAME	TruSurround HD on for cinema/game sound effect
SPORT	TruSurround HD on for sport broadcasting
STANDARD	TruSurround HD on for standard sound effect

## ■ Dolby Virtual Speaker (DVS) sound mode

The Dolby Virtual Speaker (DVS) creates virtual surrounds comparable to the 5.1ch sound produced by the 3.1ch speaker. When setting DVS to "ON" for 2 channel stereo signals, Dolby Pro Logic II brings out virtual sound effects through the signals converted into 5.1ch.

### Press the Dolby Virtual Speaker button.

The Dolby Virtual Speaker indicator lights up.

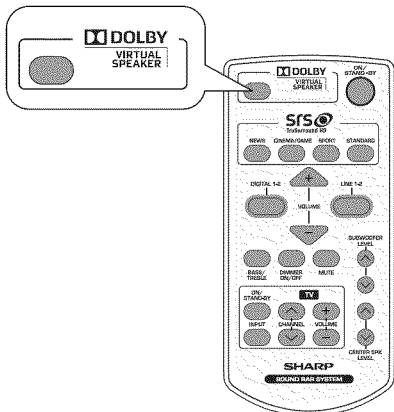

### Notes:

- Monaural signals do not generate surround effects.
- DVS sound effect may not be obtained depending on signal types (the Dolby Virtual Speaker indicator blinks). In this case, set the DVS mode to "OFF".

ON

The Dolby Virtual Speaker creates multichannel-like sound effects.

Compared with the cinema mode, the bass sound level is slightly reduced.

The Dolby Pro Logic II indicator also lights up if 2ch sound signals are detected.

- If you turn ON DVS, SRS Trusurround HD will automatically turn OFF.
- The DVS can be turned OFF by selecting other preset sound modes.

This product incorporates decoders supporting the Dolby Digital system and DTS system.

### DTS (Digital Theatre Systems)

One of the digital audio systems for theatrical use. As the sound quality is emphasised, you can enjoy the realistic sound effect in the home theatre system.

Lights up when detecting DTS signal.

### Dolby Digital

One of the digital audio systems for theatrical use. You can also enjoy the stereophonic effect in the home theatre system.

Lights up when detecting Dolby Digital signal.

### Dolby Pro Logic II

System expanding 2ch stereo sound to more spacious sound. When setting Dolby Virtual speaker to "ON", Dolby Pro Logic II is activated to enjoy the stereo sound effect.

Lights up when Dolby Pro Logic II is activated.

## General control (continued)

HT-SB500

### ■ Subwoofer level control

The speaker level can be adjusted.

**To increase** the level, press the SUBWOOFER LEVEL  $\wedge$  button.

**To decrease** the level, press the SUBWOOFER LEVEL  $\vee$  button.

#### Note:

When sound from the speaker is distorted, decrease the subwoofer level.

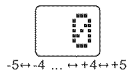

### ■ Center speaker level control

The center speaker level can be adjusted.

**To increase** the level, press the CENTER SPK LEVEL  $\wedge$  button.

**To decrease** the level, press the CENTER SPK LEVEL  $\vee$  button.

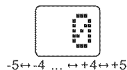

### ■ Bass control

1. Press the BASS/TREBLE button to select "BASS".

2. Within 5 seconds, press the VOLUME (+ or -) button to adjust the bass.

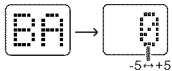

### ■ Treble control

1. Press the BASS/TREBLE button to select "TREBLE".

2. Within 5 seconds, press the VOLUME (+ or -) button to adjust the treble.

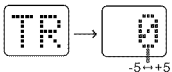

### ■ Touch Sensing off mode

During Stand-by mode, press the DIMMER/SENS ON/OFF button on the remote control and the STAND-BY indicator will turn from ORANGE to RED.

To turn the power on, press the ON/STAND-BY button on the remote control or touch the ON/STAND-BY pad on the display panel.

### ■ Function

#### On the speaker:

When the FUNCTION pad on speaker is touched, the input source will change. Touch the FUNCTION pad on speaker repeatedly to select desired input source.

#### On remote control:

Press the LINE 1-2 button repeatedly to select "L1" (LINE IN 1 input) or "L2" (LINE IN 2 input).

Press the DIGITAL 1-2 button repeatedly to select "D1" (DIGITAL IN 1 input) or "D2" (DIGITAL IN 2 input).

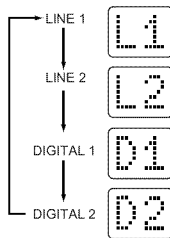

#### Note:

The backup function will protect the memorized function mode for a few hours should there be a power failure or the AC power cord becomes disconnected.

#### Auto power on function:

When you press the LINE 1-2 or DIGITAL 1-2 button on the remote control, the speaker will turn on at last function.

#### Auto power off and auto detect signal:

- If no analogue signal is detected within 1 minute or if "D1"/"D2" display is blinking and after 30 seconds during power on, the speaker will automatically go to stand-by mode. The STANDBY indicator turns orange.
- The speaker will automatically power ON if it detects audio signal from connected equipment.

#### Note:

Make sure to turn off any source/signal input to speaker before going to stand-by mode because it will cause the speaker to power ON again.

## Troubleshooting chart

Many potential problems can be resolved by the owner without calling a service technician.

If something is wrong with this product, check the following before calling your authorised SHARP dealer or service centre.

### ■ General

Symptom	Possible cause
No sound is heard.	<ul style="list-style-type: none"> <li>● Is the input signal (selection) set properly?</li> <li>● Is the volume level set to "0"?</li> <li>● Is muting activated?</li> </ul>
Noise is heard during playback.	<ul style="list-style-type: none"> <li>● Move the speaker away from any computers or mobile phones.</li> </ul>
When a button is pressed, the speaker does not respond.	<ul style="list-style-type: none"> <li>● Set this speaker to the stand-by mode and then turn it back on.</li> </ul>
The power is not turned on.	<ul style="list-style-type: none"> <li>● Is the speaker unplugged? (Refer to page 17)</li> <li>● The protection circuit may be activated. Unplug and plug in the power cord again after 5 minutes or more.</li> </ul>
The information is not displayed even if the unit is turned on.	<ul style="list-style-type: none"> <li>● Is the unit set to "Dimmer display off" mode?</li> </ul>

### ■ Remote control

Symptom	Possible cause
The remote control does not operate properly.	<ul style="list-style-type: none"> <li>● Is the battery polarity correct?</li> <li>● Is the battery dead?</li> <li>● Is the distance or angle incorrect?</li> <li>● Are there any obstructions in front of the speaker?</li> <li>● Is there a strong light shining on the remote sensor?</li> <li>● Is the remote control for another equipment used simultaneously?</li> </ul>
The speaker cannot be turned on with the remote control.	<ul style="list-style-type: none"> <li>● Is the AC power cord of the speaker plugged in?</li> <li>● Is the battery inserted?</li> </ul>
TV cannot be operated with the remote control.	<ul style="list-style-type: none"> <li>● Depending on the model, some or all functions may not be operable using the remote control of this speaker. In this case, use the remote control supplied with the TV.</li> </ul>

### ■ Condensation

Sudden temperature changes, storage or operation in an extremely humid environment may cause condensation inside the cabinet or on the transmitter or the remote control.

Condensation can cause the speaker to malfunction. If this happens, leave the power on until normal operation is possible (about 1 hour). Wipe off any condensation on the transmitter with a soft cloth before operating the speaker.

### ■ If problem occurs

When this product is subjected to strong external interference (mechanical shock, excessive static electricity, abnormal supply voltage due to lightning, etc.) or if it is operated incorrectly, it may malfunction.

**If such a problem occurs, do the following:**

1. Set the speaker to the stand-by mode and turn the power on again.
2. If the speaker is not restored in the previous operation, unplug and plug in the speaker, and then turn the power on.

### ■ Factory reset, clearing all setting

Can be operated on the remote control only.

Make sure to disconnect all audio input cables attached to the speaker before performing the factory reset.

1. Press the ON/STAND-BY button to enter the power stand-by mode.
2. Press and hold the ON/STAND-BY button until "CL" appears.



**Caution:**

This operation will erase all data stored in memory.

## Maintenance

### ■ Cleaning the cabinet

Periodically wipe the cabinet with a soft cloth.

#### Caution:

- Do not use chemicals for cleaning (petrol, paint thinner, etc.). It may damage the cabinet finish.
- Do not apply oil to the inside of each component. It may cause malfunctions.

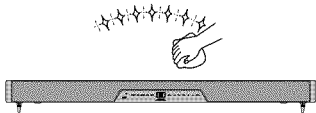

## Error indicators and warnings

When you fail to perform operations properly, the following messages are displayed on the speaker.

Display	Meaning
E1 or E2 or E3 or E4	<ul style="list-style-type: none"> <li>● Malfunction of the surround circuit. Place the speaker away from noise source and plug the AC power cord into another AC outlet. (*)</li> </ul>
D1 or D2 (Display blinks)	<ul style="list-style-type: none"> <li>● When there is no input signal. Play back the connected equipment.</li> <li>● Nonstandard signal. Cannot be recognized. Signals other than DOLBY DIGITAL, DTS, Linear PCM cannot be recognized.</li> <li>● Poor connection of the digital audio input terminal.</li> <li>● Turn off the unit and check if the cable is connected properly.</li> </ul>
 Power indicator (blinks red)	<ul style="list-style-type: none"> <li>● When the protection circuit is activated.</li> </ul>

(\*): Should the same message appear even if the speaker is unplugged and plugged in, or is set to the stand-by mode and on again, contact your local dealer where you purchased the speaker.



## Specifications

As part of our policy of continuous improvement, SHARP reserves the right to make design and specification changes for product improvement without prior notice. The performance specification figures indicated are nominal values of production speaker. There may be some deviations from these values in individual speaker.

### ■ General

<b>Power source</b>	DC IN 12V $\equiv$ 4A: AC/DC adaptor (AC 100 - 240 V ~ 50/60 Hz)
<b>Power consumption</b>	Power on: 14 W
<b>Output power</b>	<b>RMS:</b> Total 32 watts <b>RMS:</b> Front Left/Right: 5 watts per channel into 12 ohms at 1kHz, 10% total harmonic distortion Center: 7 watts per channel into 6 ohms at 1 kHz, 10% total harmonic distortion Subwoofer: 15 watts per channel into 3 ohms at 100 Hz, 10% total harmonic distortion <b>FTC:</b> Front Left/Right: Minimum 4 watts per channel into 12 ohms at 200 Hz to 20 kHz, 10% total harmonic distortion Center: Minimum 6 watts per channel into 6 ohms at 1 KHz, 10% total harmonic distortion Subwoofer: Minimum 14 watts per channel into 3 ohms at 100 Hz, 10% total harmonic distortion

<b>Speaker</b>	3.1-way Speaker System Front speakers: 1-9/16" (40 mm) Full Range (x 2) Impedance: 12 ohms / Channel Centre Speaker: 1-9/16" (40 mm) Full Range (x 2) Impedance: 6 ohms (12 ohms x 2 parallel connections) Subwoofer: 2-1/4" (57 mm) Woofer (x4) Impedance: 3 ohms (12 ohms x 4 parallel connections)
<b>Audio output terminals</b>	Subwoofer Pre Out: 10 kohms
<b>Input terminals</b>	Analogue input (LINE 1): RCA type x 1pair (L/R) 500 mV / 47 kohms Analogue input (LINE 2): Stereo mini jack $\varnothing$ 3.5 mm 100 mV / 47 kohms Coaxial digital input (DIGITAL 1): RCA type x 1 Optical digital input (DIGITAL 2): Square type x 1
<b>Dimensions</b>	Width: 38-3/4" (985 mm) Height: 3-3/4" (96 mm) Depth: 2-3/4" (70 mm)
<b>Weight</b>	4.84 lbs. (2.2 kg)

**MEMO**

**MEMO**

## CONSUMER LIMITED WARRANTY

SHARP ELECTRONICS CORPORATION warrants to the first consumer purchaser that this Sharp brand product (the "Product"), when shipped in its original container, will be free from defective workmanship and materials, and agrees that it will, at its option, either repair the defect or replace the defective Product or part thereof with a new or remanufactured equivalent at no charge to the purchaser for parts or labor for the period(s) set forth below.

This warranty does not apply to any appearance items of the Product nor to the additional excluded item(s) set forth below nor to any Product the exterior of which has been damaged or defaced, which has been subjected to improper voltage or other misuse, abnormal service or handling, or which has been altered or modified in design or construction.

In order to enforce the rights under this limited warranty, the purchaser should follow the steps set forth below and provide proof of purchase to the servicer.

The limited warranty described herein is in addition to whatever implied warranties may be granted to purchasers by law. ALL IMPLIED WARRANTIES INCLUDING THE WARRANTIES OF MERCHANTABILITY AND FITNESS FOR USE ARE LIMITED TO THE PERIOD(S) FROM THE DATE OF PURCHASE SET FORTH BELOW. Some states do not allow limitations on how long an implied warranty lasts, so the above limitation may not apply to you.

Neither the sales personnel of the seller nor any other person is authorized to make any warranties other than those described herein, or to extend the duration of any warranties beyond the time period described herein on behalf of Sharp.

The warranties described herein shall be the sole and exclusive warranties granted by Sharp and shall be the sole and exclusive remedy available to the purchaser. Correction of defects, in the manner and for the period of time described herein, shall constitute complete fulfillment of all liabilities and responsibilities of Sharp to the purchaser with respect to the Product, and shall constitute full satisfaction of all claims, whether based on contract, negligence, strict liability or otherwise. In no event shall Sharp be liable, or in any way responsible, for any damages or defects in the Product which were caused by repairs or attempted repairs performed by anyone other than an authorized servicer. Nor shall Sharp be liable or in any way responsible for any incidental or consequential economic or property damage. Some states do not allow the exclusion of incidental or consequential damages, so the above exclusion may not apply to you.

THIS WARRANTY GIVES YOU SPECIFIC LEGAL RIGHTS. YOU MAY ALSO HAVE OTHER RIGHTS WHICH VARY FROM STATE TO STATE.

### Model Specific Section

#### Your Product Model Number & Description:

#### HT-SB500 SOUND BAR SYSTEM

(Be sure to have this information available when you need service for your Product.)

#### Warranty Period for this Product:

One (1) year parts and labor from the date of purchase.

#### Additional Item(s) Excluded from Warranty Coverage (if any):

Non-functional accessories, supplies, and consumable items.

#### Where to Obtain Service:

At a Sharp Authorized Servicer located in the United States.

To find a location of the nearest Sharp Authorized Servicer, call Sharp toll free at 1-800-BE-SHARP.

#### What to do to Obtain Service:

Ship your Product prepaid to a Sharp Authorized Servicer.

Be sure to have **Proof of Purchase** available. If you ship the Product, be sure it is insured and packaged securely.

TO OBTAIN SUPPLY, ACCESSORY OR PRODUCT INFORMATION, CALL 1-800-BE-SHARP.

# SHARP®

## SHARP ELECTRONICS CORPORATION

Sharp Plaza, Mahwah, New Jersey 07495 - 1163

### SHARP CORPORATION



TINSEA314AWZZ

Printed in Malaysia

09L R MW ①