

VIORETM TECHNOLOGY & INNOVATION

OPERATING INSTRUCTIONS

***32" 1080P LCD Television
with Built-in Blu-ray Disc Player***

LCD32VXF60BD

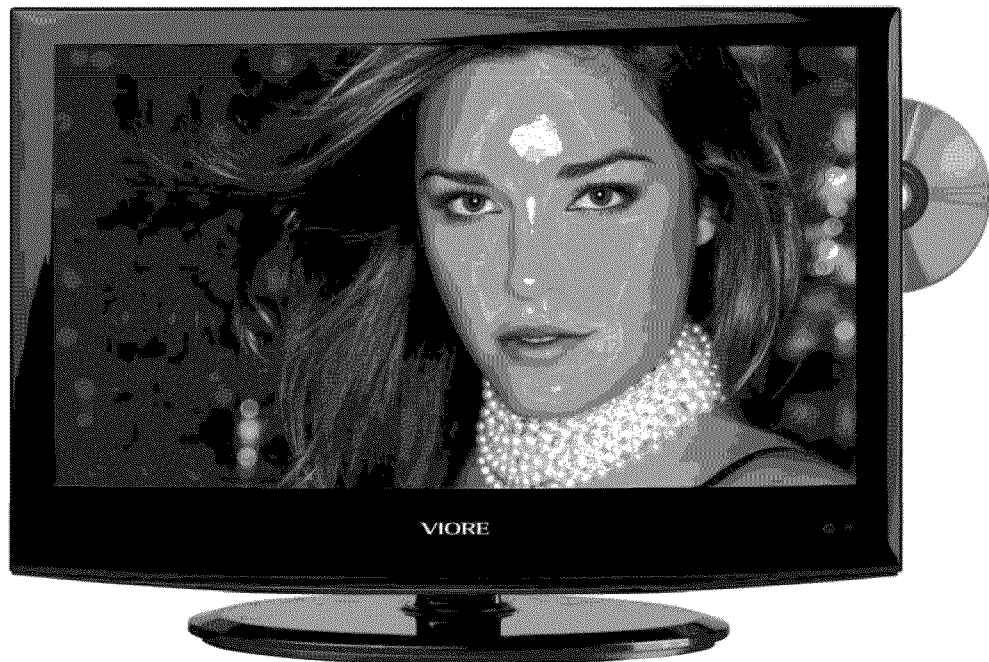

AIR (TV)/CABLE MODE SELECTION

The Air/CABLE menu option is set to the "CABLE" (Cable Television) mode at the factory. If you want to use an antenna for the built-in TV tuner, this menu option must be set to the "Air" mode. Please refer to page 19 of the owner's manual for the details of this menu.

FOR QUESTIONS OR TECHNICAL SUPPORT		
PARA PREGUNTAS O APOYO TECNICO		
Please call: / Favor de llamar al:		
STOP	1-877-777-1428	(USA/CANADA/ PUERTO RICO)
	Please do not return this TV to the store	
Por Favor NO Regrese este Televisor a la Tienda		

CONTENTS

Safety Precautions

- Caution 1
- Safety Information 2
- Blu-ray Disc Player-Caution 3
- Blu-ray Disc Player- Information 4

User Guidance Information

- Names of each part(Front View) / Accessories 5
- Names of each part(Back View) 6
- Mounting on a Desktop / Installation Precautions 7
- Installing an Antenna 8
- Remote control 9~10
- Precautions / How to use remote control 11

Basic Use

- Powering the LCD TV / Selecting input source 12

Application

- Operating the Menu 13
- Customizing the PICTURE Settings 14
- Customizing the SOUND Settings 15
- Customizing the TIMER Settings 16
- Customizing the SETUP Settings 17
- Customizing the LOCK Settings 18
- Customizing the CHANNEL Settings 19

Blu-ray Disc Player

- Blu-ray Disc Player Operation 21-40

Maintenance and Service

- Trouble shooting 41
- Specifications 42

Caution



The lightning flash with arrowhead symbol, within an equilateral triangle is intended to alert the user to the presence of un-insulated "dangerous voltage" within the products enclosure that may be of sufficient magnitude to constitute a risk of electric shock to the persons.



The exclamation point within an equilateral triangle is intend to alert the user to the presence of important operating and maintenance (servicing) instructions in the literature accompanying the appliance.



Correct disposal of this Product

Waste Electrical & Electronic Equipment (WEEE)

Your product is designed and manufactured with high quality materials and components which can be recycled and reused.

This symbol means that electrical and electronic equipment, at their end-of-life, should be disposed of separately from your household waste.

Please dispose of this equipment at your local community waste collection/recycling centre.

Safety Information

To ensure reliable and safe operation of this equipment, please read carefully all the instructions in this user guide, especially the safety information below.

Electrical safety

- The TV set should only be connected to a mains supply which matches that stated on the label.
- To prevent overload, don't share the same mains supply socket with too many other items of equipment.
- Do not place any connecting wires where: they may be stepped on or tripped over.
- Do not place heavy items on them, which may damage the leads.
- Hold the main plug, not the wires, when removing from a socket.
- During a thunderstorm or while leaving the TV for long periods, set the switch off.
- Do not allow water or moisture to enter the TV or mains adaptor. Do NOT use in wet or moist areas, such as Bathrooms, steamy kitchens or near swimming pools.
- Pull the plug out immediately, and seek professional help if: the mains plug or cable is damaged, liquid is spilt onto the set, or if it is accidentally exposed to water or moisture, anything accidentally penetrates the ventilation slots, the set doesn't work normally.
- Do not remove the safety covers. There are no user serviceable parts inside. You may invalidate the warranty. This apparatus must only be serviced by qualified personnel.
- To avoid battery leakage, remove exhausted batteries from the remote control, or when not using for a long period.
- Do not break open or throw exhausted batteries on a fire.

Physical safety

- Do not block ventilation slots in the back cover. You may place the TV in a cabinet, but ensure at least 5cm (2") clearance all around.
- Do not tap or shake the TV screen, or you may damage the internal circuits. Take good care of the remote control.
- To clean the TV use a soft dry cloth. Do not use solvents or petrol based fluids.
- Do not install near any heat sources such as radiators, heat registers stoves or other apparatus (including amplifiers) that produce heat.
- Do not defeat the safety purpose of the polarized or grounding-type plug. A polarized plug has two blades with one wider than the other. A grounding type plug has two blades and a third grounding prong, the wide blade or the third prong is provided for your safety. If the provided plug does not fit into your outlet, consult an electrician for replacement of the obsolete outlet.
- Protect the power cord from being walked on or pinched particularly at plugs.
- Use only attachments/accessories specified by the manufacturer.
- Unplug this apparatus during lightning storms or when unused for long periods of time.
- Refer all servicing to qualified service personnel. Servicing is required when the apparatus has been damaged in any way, such as power-supply cord or plug is damaged, liquid has been spilled or objects have fallen into the apparatus, has been exposed to rain or moisture, does not operate normally or has been dropped.
- Please always connect an apparatus with Class I structure to a main socket with protective earthing connection.
- Please make sure both main plug and appliance coupler work properly.

Blu-ray Disc Player

CAUTION

THIS PRODUCT UTILIZES A LASER. USE OF CONTROLS OR ADJUSTMENTS OR PERFORMANCE OF PROCEDURES OTHER THAN THOSE SPECIFIED HEREIN MAY RESULT IN HAZARDOUS RADIATION EXPOSURE. DO NOT OPEN PRODUCT CASING - THERE ARE NO USER-SERVICEABLE PARTS INSIDE. REFER SERVICING TO QUALIFIED PERSONNEL.



Note:

- This unit can be used only where the power supply is AC 100-240V~, 50/60Hz. It cannot be used elsewhere.
- This Blu-ray disc player is designed and manufactured to respond to the Region Management Information encoded into some DVDs and BDs (Blu-ray discs).

If the Region number of a BD/DVD disc does not correspond to the Region number of this Blu-ray disc player, the Blu-ray disc player cannot play the disc.

This license is limited to private non-commercial use by end-user consumers for licensed contents. No rights are granted for commercial use. The license does not cover any product unit other than this product unit and the license does not extend to any unlicensed product unit or process conforming to ISO/IEC 11172-3 or ISO/IEC 13818-3 used or sold in combination with this product unit.

The license only covers the use of this product unit to encode and/or decode audio files conforming to the ISO/IEC 11172-3 or ISO/IEC 13818-3. No rights are granted under this license for product features or functions that do not conform to the ISO/IEC 11172-3 or ISO/IEC 13818-3.

Restrictions on Playback

- This player may not respond to all operating commands because some BD, DVD or CD discs allow specific or limited operation and features during playback. Please note that this is not a defect in the player.
- The manufacturer cannot assure that this player will play every disc bearing the BD, DVD and CD logos because disc formats may evolve, and problems and errors can occur during the creation of BD, DVD and CD software and/or the manufacture of discs.

This player also operates differently than a standard DVD player or other AV equipment. Please contact the customer support center if you have questions or encounter difficulty in playing BD, DVD or CD discs in this player. Also, refer to the rest of this Manual for additional information on playback restriction.

Disc Handling Precautions

- This Blu-ray disc player supports discs that are compatible with DVD-RAM Standard Version 2.0.
- Avoid touching the surface of a disc
- Be careful not to leave fingerprints or scratches on the surface of the Disc.
- Do not use cleaners or cloths for CDs to clean BD or DVD-RAM-RW/-R discs.
- Wipe off dirt or contamination on the disc with a soft cloth.
- If the player is not used for a long period of time, remove any discs from the player and store it in its case.
- Do not write on the disc with a ball-point pen or pencil.
- Do not use record cleaning sprays or antistatic. Also, do not use volatile chemicals, such as benzene or thinner.
- Do not apply labels or stickers to discs. (Do not use discs with exposed tape adhesive or leftover peeled-off stickers.)
- Do not use scratch-proof protectors or films.
- Do not use discs printed with label printers available on the market.
- Do not insert warped or cracked discs.

Disc Storage

- Do not keep under direct sunlight.
- Keep discs in a cool ventilated area.
- Store vertically.
- Keep in a clean protection jacket.
- If you move your Blu-ray disc player suddenly from a cold place to a warm place, condensation may generate on the operating parts and lens and cause abnormal disc playback. If this occurs, do not connect the plug to the power outlet and wait for two hours. Then insert the disc and try to play back again.

Names of each part

Front View

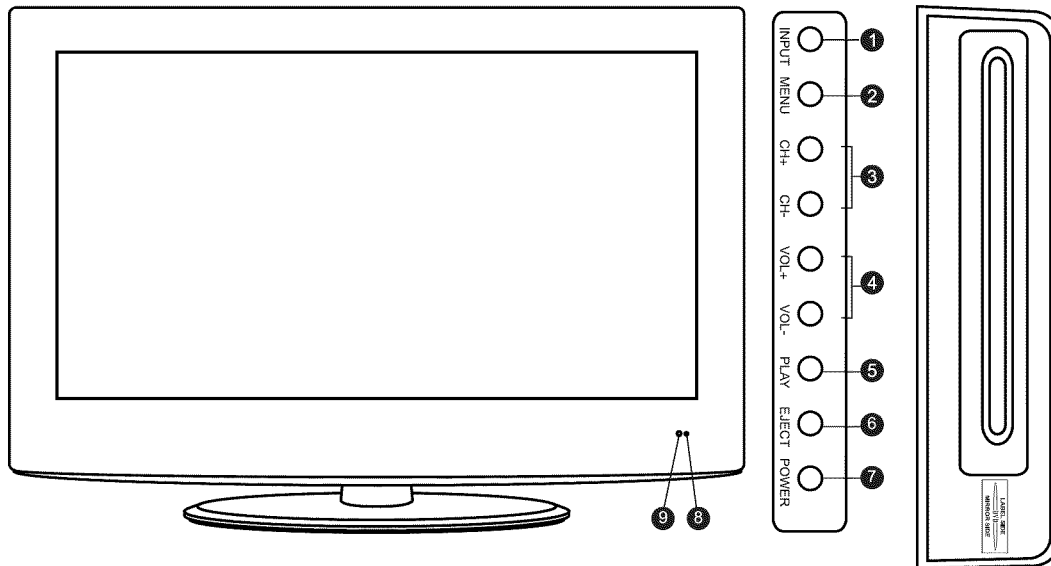

Please insert a 12cm disc according to the silk

- | | |
|---|-------------------------|
| ① INPUT button - Input Source Select Button | ⑥ Eject the disc |
| ② MENU button - OSD Menu Display Button | ⑦ POWER button |
| ③ CH+/- button - Channel/Program +,- Button | ⑧ LED Indicator |
| ④ VOL+/- button - Volume +,- Button | ⑨ Remote Control Window |
| ⑤ Play / Pause the disc playing | |

Accessories

- The configuration of the components may look different from the following illustration.

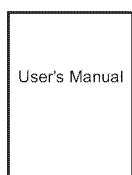

User's Guide



Power Cord

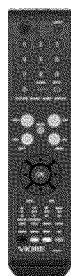

Remote Control



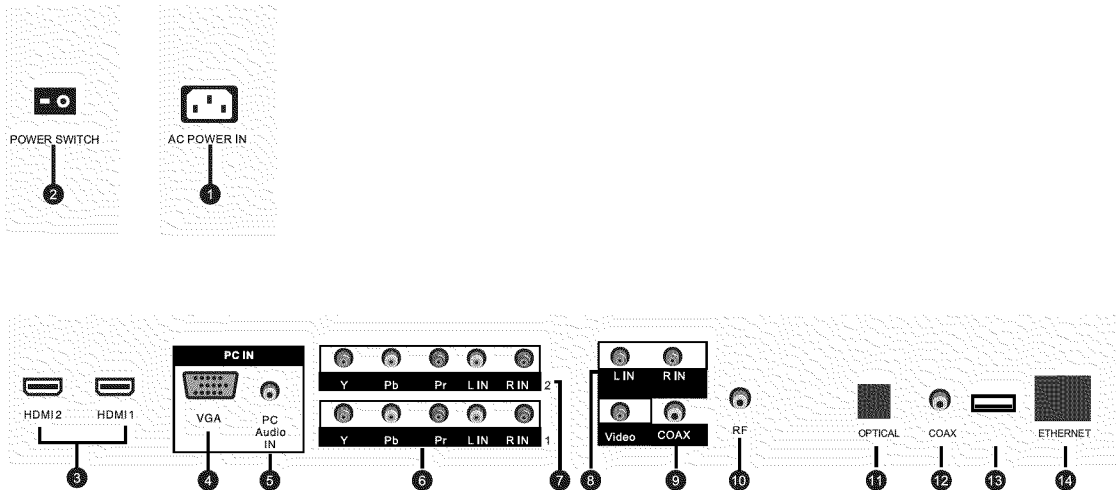

Batteries for Remote Control
(Size AAA x 2 pcs)

Names of each part



1. **AC POWER IN:** Connect to an earth 100-240V, 50/60Hz AC outlet with the PowerCable.
2. **SWITCH:** Switch on or off the power supply.
3. **HDMI1/2:** Connect them to the video output terminal of DVD.(used in HDTV1 mode)
4. **VGA:** For PC display. Connect it to the D-Sub 15 pins analog output connector of the PC.
5. **PC AUDIO IN:** Connect it to the audio output terminal of PC.
6. **YPbPr 1:** Connect them to the video output terminal of DVD.(used in HDTV1 mode).
L/R in 1: Connect them to the audio output terminal of DVD(with YPbPr 1)
7. **YPbPr 2:** Connect them to the video output terminal of DVD.(used in HDTV2 mode).
L/R in 1: Connect them to the audio output terminal of DVD(with YPbPr 2).
8. **VIDEO:** Connect it to video output terminal of DVD.
L/R in: Connect them to audio output terminal of DVD.
9. **COAX:** Digital coaxial output.
10. **RF:** Connect antenna or cable 75 Ohm coaxial to receive TV signal.
11. **BD-OPTICAL:** Blu-ray player's optical audio output.
12. **COAX:** coaxial digital audio output.
13. **USB:** USB Port for BD player.
14. **ETHERNET:** ethernet connector for BD-live capabilities.

- To turn on the LCD TV

Press  on the LCD TV to  first.

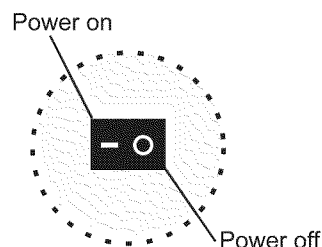

- Be sure to turn off the power and unplug both units from the wall outlet before making any connections.

Placing on a Desktop

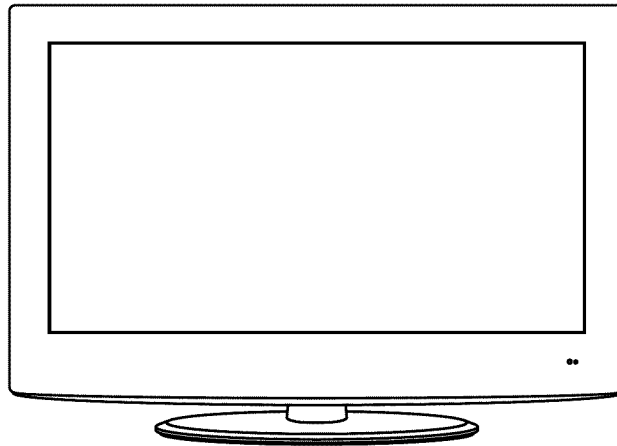

- Your LCD TV can be placed on a Desktop as shown in the figure above.
- Please refer to the following precautions "Using the Stand".

Installation Precautions

Wall Mounting

- Please secure enough space for safe use. (Please refer to A and B.)
- Installation of the LCD TV in an improperly ventilated location can cause a fire or damage to the LCD TV due to increased temperature.

A →
(Mounting on a wall)

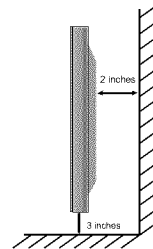
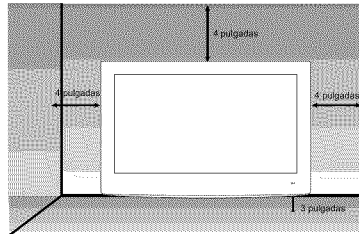

※ Contact your dealer to purchase the "Adjustable-angle wall mount" required for wall-mounted installation.

Using the Stand

- Do not install on an unstable location with support area smaller than the LCD TV.

B →
(Using the Stand)

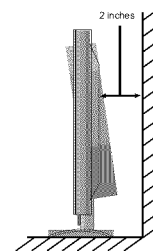
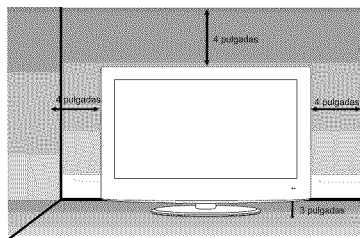

Installing an Antenna

- For connecting to ATSC or NTSC broadcasts

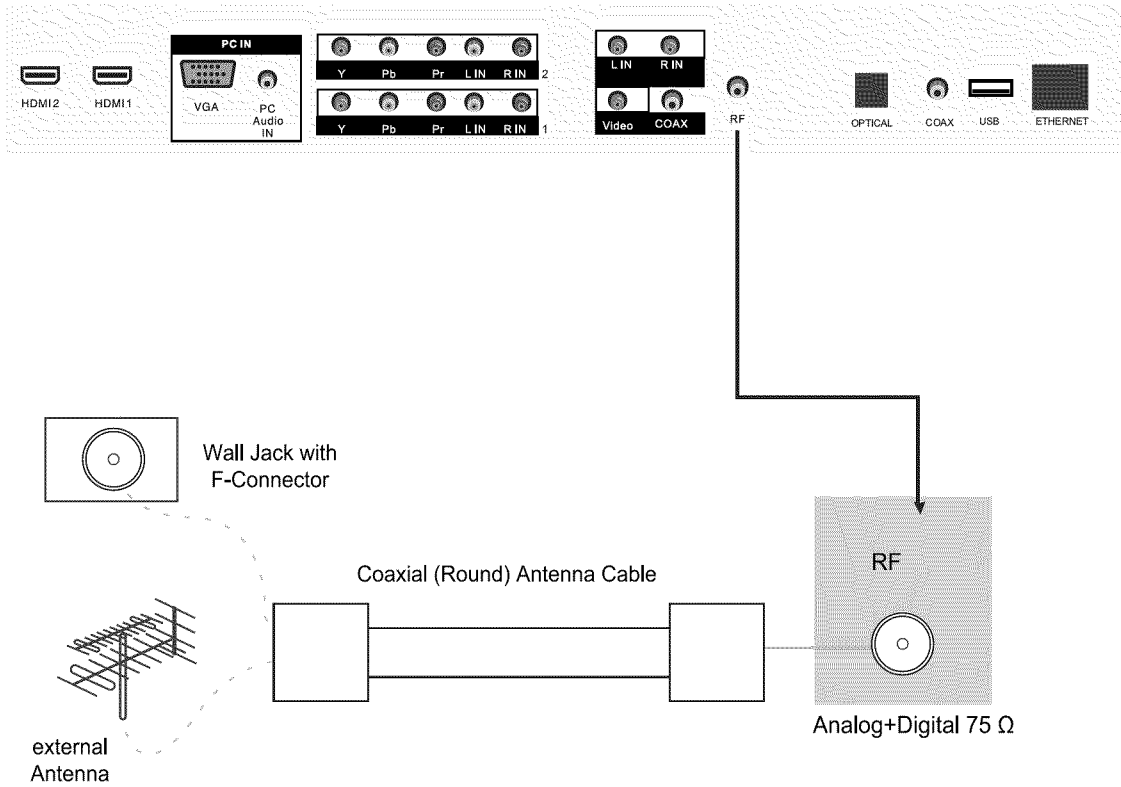

Press INPUT button on the remote control to select TV, then press OK button to confirm. Then you can receive the ATSC/NTSC signal.

Remote Control

● Functions of remote control buttons

The remote control is using Infra-Red (IR). Point it towards the front of the LCD TV. The remote control may not work correctly if it is operated out of range or out of angle.

POWER
Press to turn the TV on/standby

PICTURE
Press repeatedly to cycle through the available video picture modes.

SOUND
Press to cycle through the different sound settings.

SLEEP
Press to setup the sleep time

DISPLAY
Press to enter the EPG menu directly.

CH+/-
Channel/Program +/-

VOL+/-
Volume +/-

MENU
Press to display the OSD menu.

EXIT
Press to exit form the OSD menu.

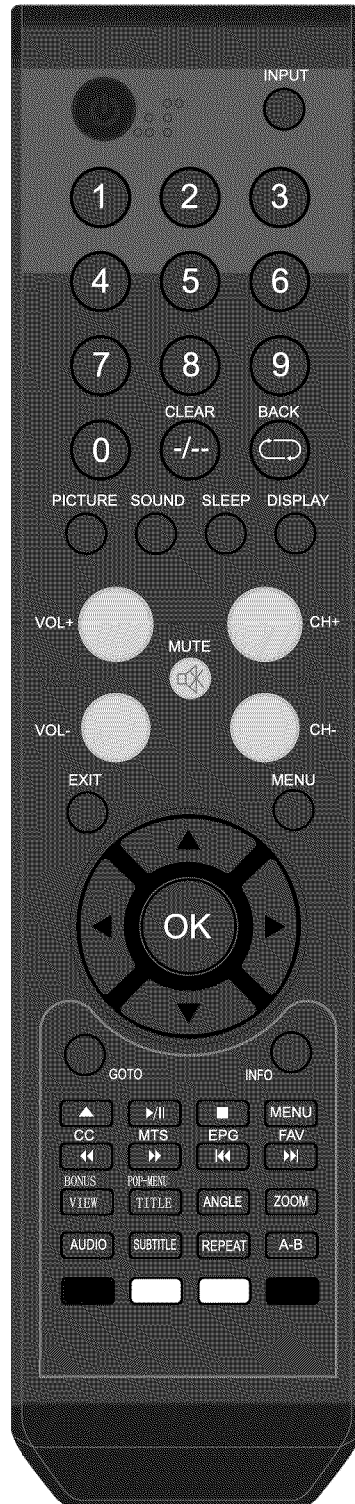

INPUT
Press to display the input source menu

NUMBER BUTTONS
To select the program directly.
e.g.:

Select channel 5,
press "5" button.
Select channel 62
press "6" button, and press "2"
button in 2 seconds.
Select channel 152
press "1" button, and press "5"
button, then press "2" button
in 2 seconds.
select channel "5-1",
press "5" then "-/--" and "1".

Return to the previous channel viewed.

MUTE
Press to mute the sound.
Press again or press VOL+ to unmute.

THUMBSTICK (▲/▼/◀/▶/OK)
Allows you to navigate the on-screen menus and adjust the system settings to your preference.

CC
Press to display the closed caption.

MTS
Press to select the audio channels.

EPG
Press to enter the EPG menu directly.

FAV
Press to display the favorite channels list.

Remote Control

Numeric Keypad

These buttons are used with GOTO button to move to a specific track on BD,DVD and CD.

CLEAR

When entering numeric values via the numeric keypad,this button is used to clear a number entered incorrectly.

BACK

Return to previous option.

Menu Navigation Keys

These buttons are used when navigating the menus on BD and DVDs.They are also used for navigating the setup menus for the BD player.



DVD eject.



Play/Pause DVD program.



Stop DVD program.

MENU

DVD play list/Disc menu



DVD fast reverse.



DVD fast forward.



DVD previous chapter.



DVD next chapter.



GOTO

Play your favorite title/chapter/track.

INFO

Display the information of the disc.

BONUS VIEW

PIP function of some blue-ray disc.
(Not available on all disc)

POP-MENU

On BD discs only,this button can be used to pull up menus that are specific to the scene being played.
(Not available on all disc)

TITLE

DVD title.

ANGLE

Some BD and DVDs are filmed with more than one camera angle.During playback of such a disc pressing this button will allow you to switch at the beginning and end of it

ZOOM

Adjust picture size in DVD mode.

AUDIO

Select BD and DVD disc language.

SUBTITLE

Select BD and DVD disc subtitle.

REPEAT

Repeat playing the title or chapter.

A-B

Select and play the preferable paragraph of DVD program by pressing this key twice at the

A-B-C-D

The red,green,yellow and blue keys are used for playing "special feature" games on some BD disc.
e.g. :bookmark function.

Precautions

Avoiding Remote Control Problems

1. Check the polarity (+,-) of the batteries in the remote control.
2. Check that the batteries have power.
3. Check that the LCD TV is powered and that it is properly plugged in.
4. Check if any three-wavelength lamp, special fluorescent or neon sign is turned on near the LCD TV.

Inserting Batteries in the Remote Control

1. Open the cover completely.
2. Insert the two supplied batteries. Ensure that the polarities (+ and -) of the batteries are aligned correctly.
3. Slide back the cover.

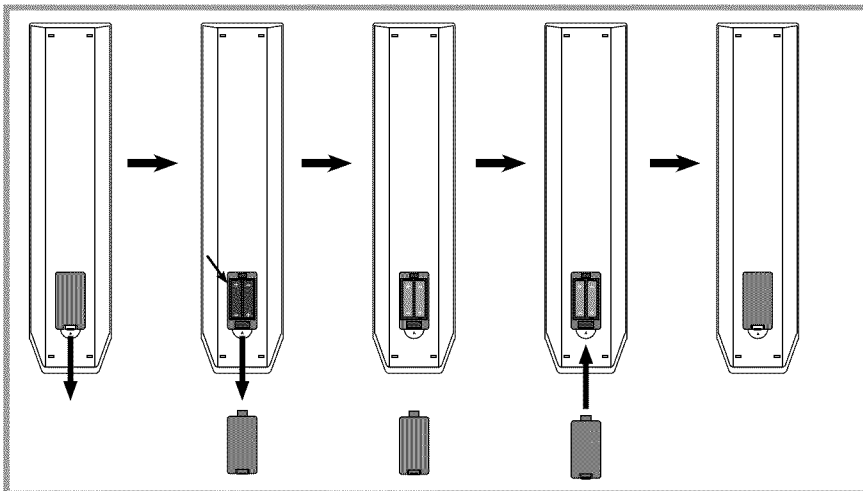



⚠ CAUTION : Risk of explosion if battery is replaced by an incorrect type.
Dispose of used batteries according to the national code (Recycling program).

How to use remote control

- The remote control should be operated within 30 feet (7m) and 30° to the left and the right of the IR receiver at the front of the LCD TV.
- Used batteries should be disposed properly.

Powering the LCD TV

● Power on/ off

Press  on the bottom of the LCD TV to  first.

· To turn the LCD TV on :

Press "POWER" button on the LCD TV.

· To turn the LCD TV off :

Press "POWER" button on the LCD TV.

· To turn on/off by remote control :

Press the  button of remote control.

Selecting Input Source

- You can select between the TV signal and the input signal of other equipments connected to the TV.
- Use this function to switch to the input source you wish to view.

Press  button on the remote control.

Use  to move to the desired input source.

Press  to select.

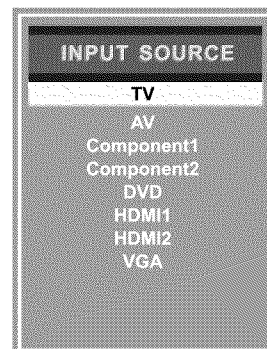

Basic OSD Menu operation

Press **MENU** button to display the OSD menu as below:

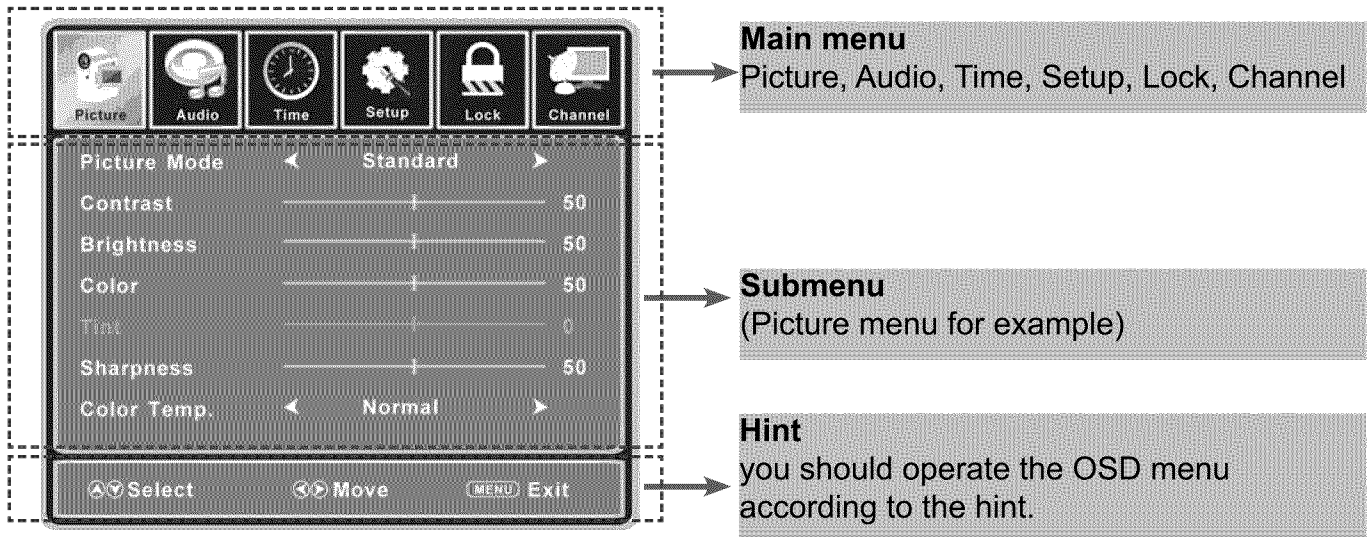

Use < / > button to select the main menu, and press √ button to enter the submenu.

In the submenu, use ^ / v button to select the function item, and you could:

adjust ("Contrast" item in **Picture** menu for example) with < / > button;

select ("Picture Mode" item in **Picture** menu for example) with < / > button;

enter the submenu ("Close Caption" item in **Setup** menu for example) with > button.

* (Press MENU button to return to the upper menu.)

* (Press EXIT button to exit the menu display.)

Note1: Only when you input the suitable signal, the relevant items can be activated

Note2: Please operating the OSD menu according to hint on the bottom of the banner.

OSD Menu

1. Picture menu

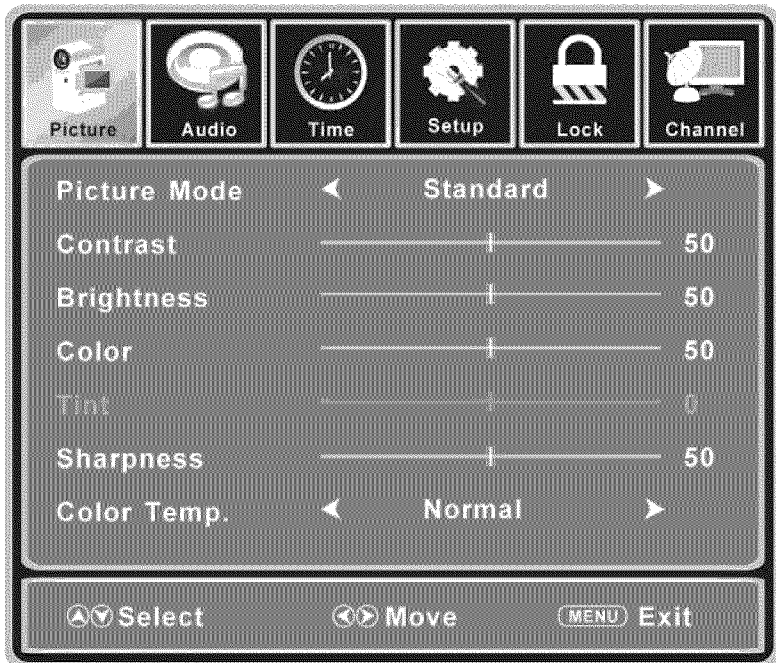

Description

Picture mode: Select between Standard, Dynamic, Mild, Sports and User.

You may select the picture mode directly by pressing the **PICTURE** button on the remote control.

Contrast: Control the difference between the bright and dark regions of the screen picture.

Brightness: Adjust brightness of the picture.

Color: Adjust color of the picture.

Tint: Control the fresh tones to make them appear natural.

Sharpness: Set the amount of fine detail in the picture.

Color Temp.: select between Normal, Cool and Warm.

2. Audio menu

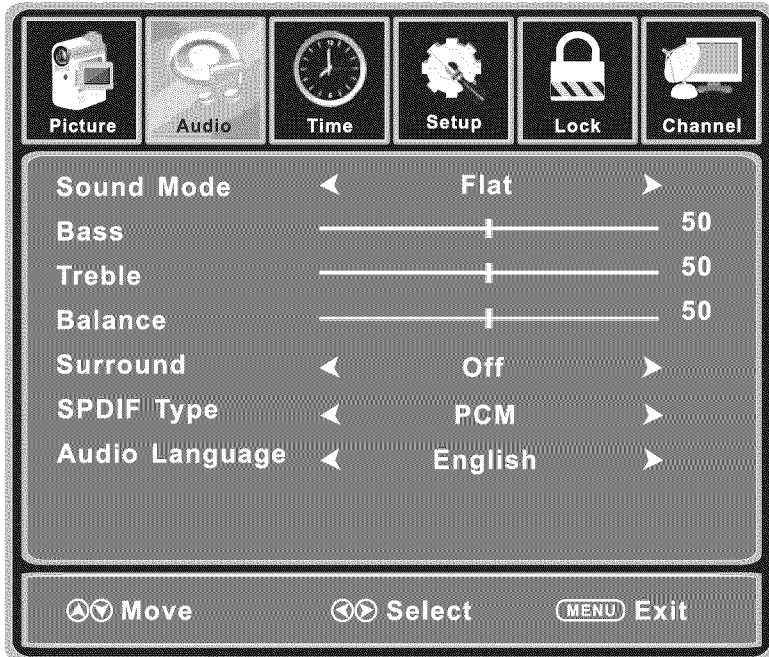

Description

Sound Mode: Select your desired picture mode as follow: Flat, Music, Movie, Sports and User
You may select the sound mode directly by pressing the **SOUND** button on the remote control.

Bass: Low frequencies intensity.

Treble: High frequencies intensity.

Balance: Left and right stereo audio channels balance.

Surround: Activate or deactivate the Surround function.

SPDIF Type: Allows you to select between PCM and RAW.

Audio Language: Select audio language.

3. Time menu



Description

Sleep timer: You may set the automatic shutdown timer choosing from 5 to 240 minutes, or deactivate this function.

Time zone: Select between Pacific, Alaska, Hawaii, Eastern, Central and Mountain.

Daylight Saving Time: Select between On and Off.

Clock: Display the Date/Time according to the DTV program.

4. Setup menu



Description

Menu Language: Select OSD menu language.

Transparency: Turn on or off the transparency menu function.

Zoom Mode: Select the zoom mode between 16:9, 16:9 zoom, 4:3, 4:3 zoom.

Noise reduction: Select the noise reduction mode between Strong, Off, Weak and Middle.

PC SETUP: If the video input signal comes from your PC, you may adjust the V-Position, H-Position, Frequency, Phase or even perform an Auto adjustment.

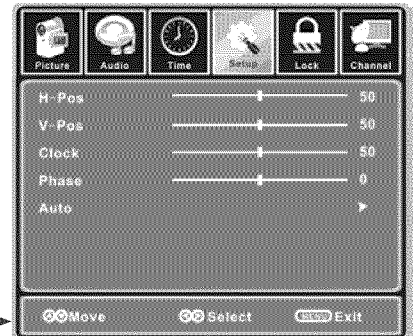

Closed Caption:

CC Mode: Allow you to select the CC Mode among: On, Off and CC on Mute.

Basic Selection: Allow you to select the basic selection among: CC1, CC2, CC3, CC4, Text1, Text2, Text3 and Text4.

Advanced Selection: Allow you to select the advanced selection among: Service1, Service2, Service3, Service4, Service 5 and Service 6.

Option: Use thumbstick buttons to operating in option menu as your desire.

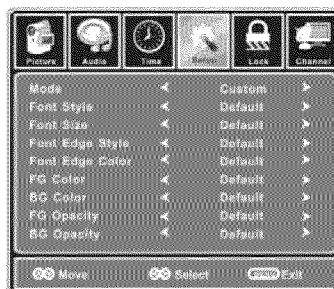
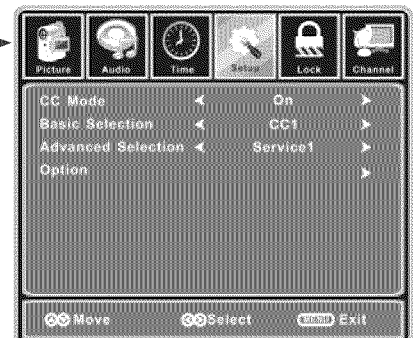

XVS: Activate / deactivate the automatic dynamic brightness function.

Restore Default: Restore all settings in SETUP menu to factory settings.

5. Lock menu

You must enter the password to gain access to the Lock menu. The default password is 0000. You may modify the following options:

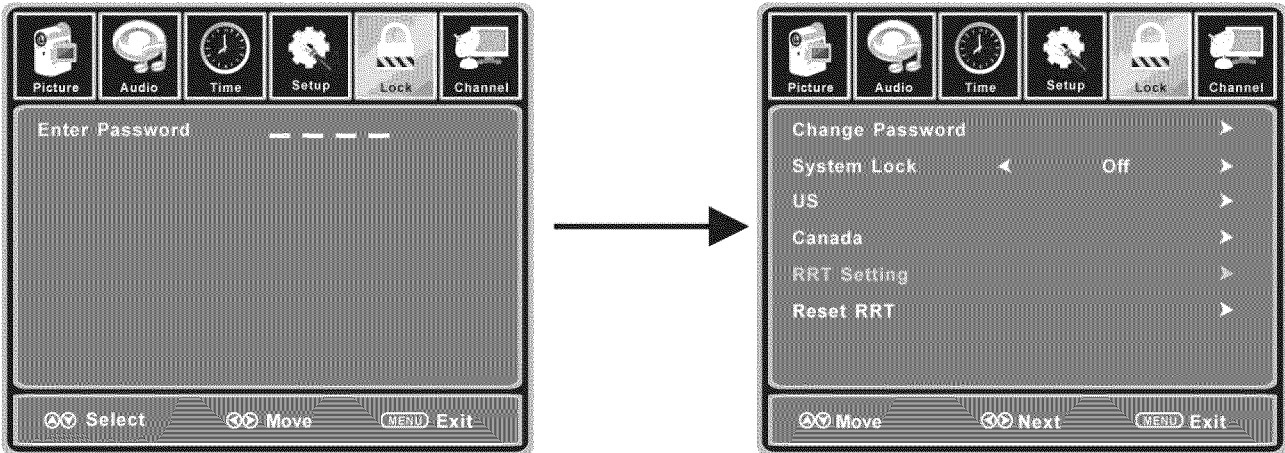

Description

Change password: Change the password, you must enter the new password twice to confirm it. Note: Do not forget the password.

Lock: Allow you to turn on or off the system lock. If deactivated, the functions described below don't work.

This option menu allows you to lock any TV channel or adjust the Movie rating filter.

US: _____

TV: Use \wedge / \vee buttons to select the desired rating and press $\>$ button to block or unblock rating.

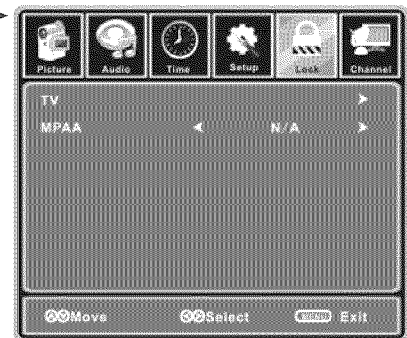
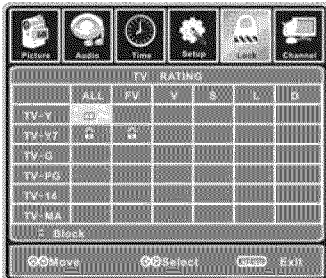

MPAA: The Movie rating (MPAA) is used for original movies rated by the Motion Picture Association of America (MPAA) as broadcasted on cable TV and not edited for television.

Use \wedge / \vee button to select N/A, G, PG, PG-13, R, NC-17 or X.

RATING	DESCRIPTION
G	General Audiences. Movie is appropriate for all ages.
PG	Parental Guidance Suggested. May contain material not suited for younger viewers.
PG-13	Contains content that may not be appropriate for viewers under the age of 13.
R	Restricted. Contains adult content, no one under 17 admitted without parent.
NC-17	No one 17 and under admitted.
X	Adults only.

Canada: _____

Canada English: Select among: E, C, C8+, G, PG, 14+ and 18+.

Canada French: Select among: E, G, 8ans+, 13ans+, 16ans+ and 18ans+.



Reset RRT: Allow you to reset the RRT setting.

6. Channel menu

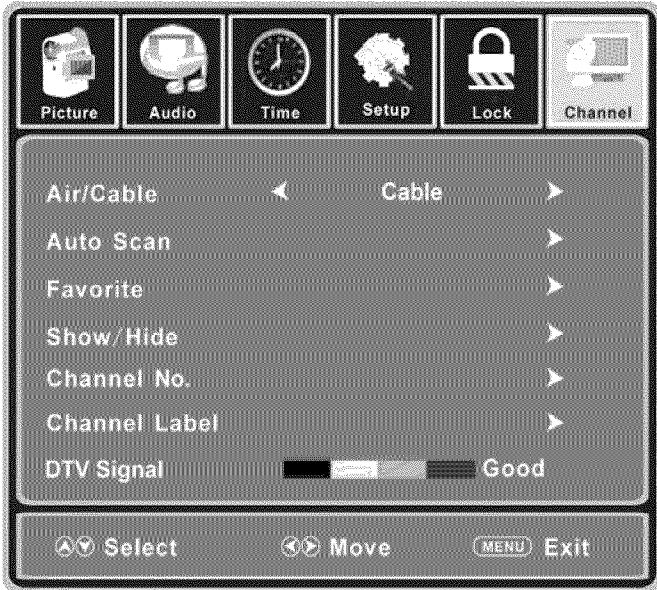

Description

Air/Cable: Allow you to select antenna between Air and Cable.

If you select "Cable", the following items(Favorite, Show/Hide, Channel NO, Channel Label and DTV Signal) are unable to use.

Auto Scan: Enter the Auto Scan menu to start auto scan.

- ★ If you select "Cable" as input signal in Antenna item, allows you to select Cable System among: Auto, STD, IRC and HRC. Use \downarrow button to highlight the "Start to Scan", then press \rightarrow button to search the channels automatically. The receivable channels will be stored automatically. When searching channels, press **MENU** to stop.

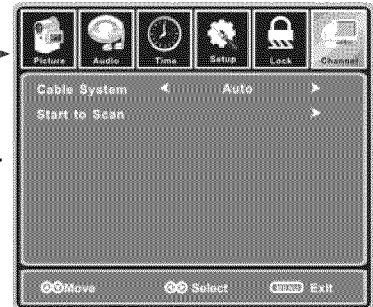

- ★ If you select "Air" as input signal in Antenna item, you can press \rightarrow button to search the channels automatically. The receivable channels will be stored automatically. When searching channels, press **MENU** to stop.
NOTE: It will take a while to auto scan in NTSC or ATSC mode, please wait patiently.

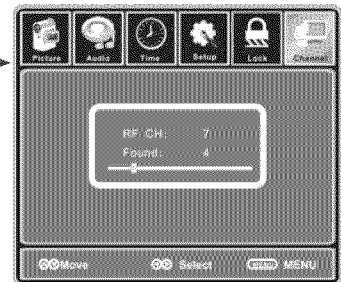

Favorite: Allow you to add these channels which you desired as the favorite channels.

Use \wedge / \vee button to highlight the desired item, then press **OK** button to add or remove the highlighted channel as favorite.

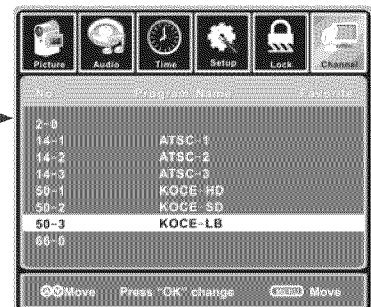

Show/Hide: Allow you to show or hide the channels.

Use \wedge / \vee button to highlight the desired item, then press **OK** button to show or hide the highlighted channel.



Channel No.: Show and select the channel.

Channel Label: Allow you to setup a label for the channel.

Press $<$ / $>$ button to select the position of the table, and press \wedge / \vee button to select the words.

DTV Signal: Show the quality of digital signal: good, Normal, Bad.







1 INTRODUCTION

1.1 OVERVIEW

Your Blu-ray (BD) player has the capability of providing high-definition and cinema-like pictures. Soundtracks in more than one language are usually included on the disc and subtitle in more languages are often included as well.

1.2 PLAYABLE DISC TYPES

The following types of discs can be played in this BD player:

Blu-Ray™ Discs		DVD-or+RW	
DVD Video Discs (DVD-ROM)		DVD-or+R	
Audio CDs (CDDA)		DTS-CD	
DVD-RAM		Mp3 / Jpeg Data CD	
VCD			

NOTES:

For writeable DVD discs (DVD-RAM, DVD-RW, DVD-R)

- DVD-RAM/-RW/-R recorded with UDF or ISO9660 format can be played back.
- The discs must be finalized, VR-mode only.
- This Blu-ray disc player supports discs that are compatible with DVD-RAM Standard Version 2.0.
- Playback may not work for some types of discs, or when specific operations, such as angle change and aspect ratio adjustment, are being performed. Information about the discs is written in detail on the disc's casing. Please refer to this if necessary.
- Some DVD-VR discs will play. Not all features will be available.

For writeable CD discs

- CD-R/-RW media recorder with UDF or ISO9660 format can be played back.
- MP3 files must be written to the disc with a .mp3 (or .MP3) file extension in order to be recognized and played back properly on this player.
- Windows Media Audio (WMA) files must be written to the disc with a .wma (or .WMA) file extension in order to be recognized and played back properly on this player.
- JPEG picture files must be written to the disc with an .jpeg or .jpg file extension on order to be recognized and played back properly on this player.

REGION CODE

Many commercially-available DVD and BD discs have region coding information included for several reasons including customising the content for different markets. The Region codes for BD and DVD for this player are shown below - region-encoded discs must have the same region code in order to be played on this unit.



DVD



Blu Ray

2 SETUP MENU

2.1 SETUP MENU OPERATION

2.1.1 Invoking the Setup Menu

After the BD player has been turned on, enter the SETUP menu by pressing the "OK" key on the remote. The following screen will appear:

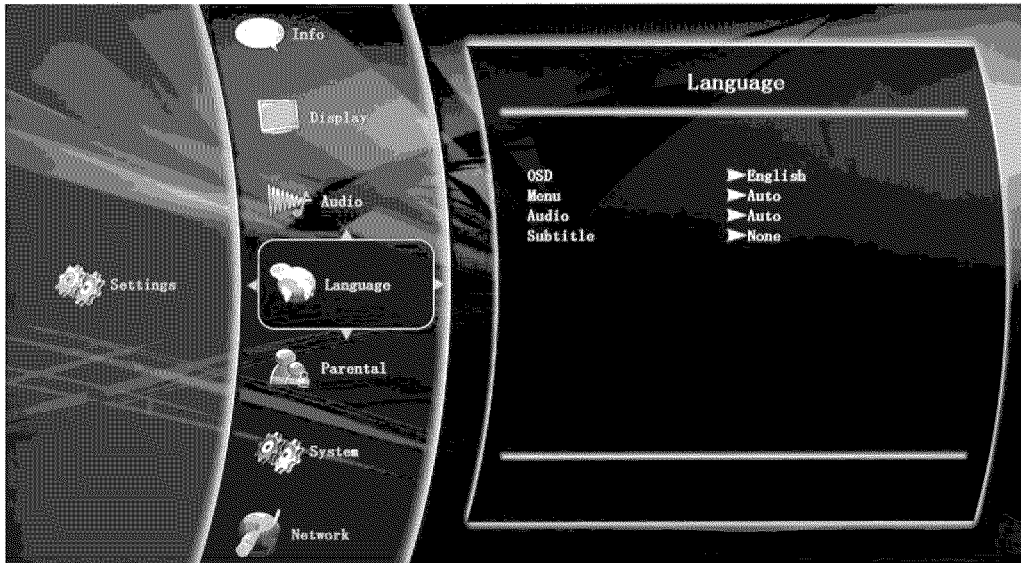

As shown in the figure above, the Setup Menu screen is divided into *three* separate sections.

The LEFT section indicates that you are in the Settings (SETUP) menu. If a disc is inserted, it will be shown here as well.

The MIDDLE section shows the menu categories. The categories can be chosen using the UP/DOWN arrow keys.

The RIGHT section shows the options within the highlighted menu category in the middle section. The current setting for each of these options is also shown, and can be changed with the RIGHT/ENTER button on the remote control.

By pressing the up/down arrow keys (▲▼) on the remote, different setup menu categories can be highlighted.

2.1.2 Changing Setup Menu Options

In the Center section, move UP/DOWN arrow on remote to go to desired Setup Menu Category (Info, Display, Audio, Language, Parental, System, Network etc.), press Enter key on remote control to make selection. The selected Setup Menu Category will be highlighted, press right arrow key and make changes on Right section for each setting opinions, press Enter key on remote to confirm and save change or changes just made.as shown below:

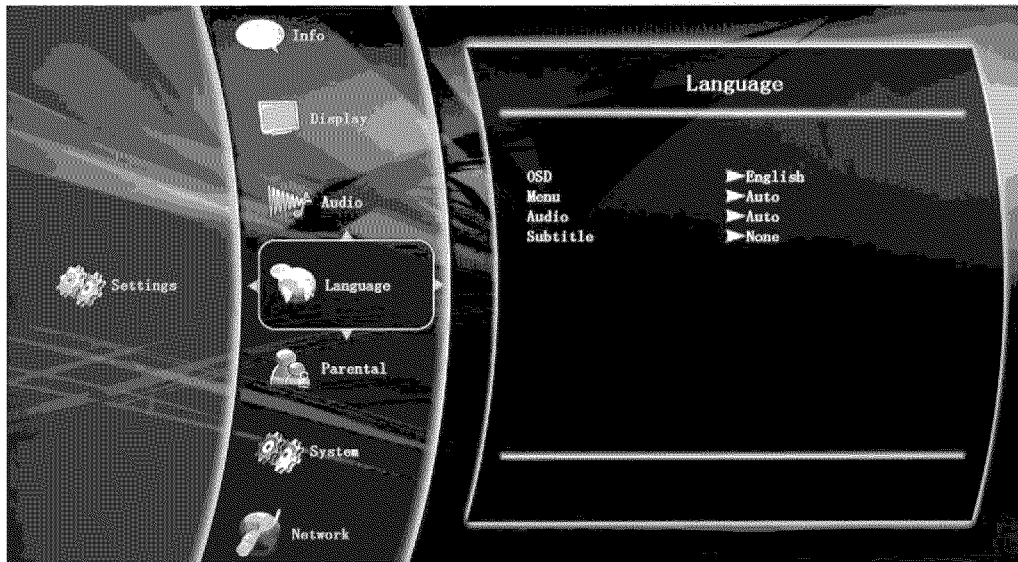

By pressing the up/down arrow keys (▲▼) on the remote and moving the highlighting, the setting for each option can be changed by pressing the OK key (OK) once the desired choice is highlighted. The *currently saved* setting will be shown for remind

In order to configure the BD player for proper audio and video output, press the up/down arrow keys (▲▼) on the remote until one the following setup menu categories is highlighted:

Language

Display

Audio

Parental

System

Network - shows current network settings (for BD-Live capability)

Info - shows general unit information

The First 5 of these menus is described in more detail in the next sections.

2.2 LANGUAGE MENU CATEGORY

From the main setup menu, press the up/down arrow keys (▲▼) on the remote until the **Language** menu category is highlighted. Then, press the right arrow key (▶) on the remote until the center portion of the setup screen is highlighted.

Each of the menu choices will be explained below.

2.2.1 Audio Language

To set the player's audio language, press the up/down arrow keys (▲▼) on the remote until the **Audio** menu choice is highlighted in the center of the setup menu screen. Then, press the right arrow key (▶) on the remote until the right portion of the setup screen is highlighted.

The up/down arrow keys (▲▼) on the remote can then be used to select English, French, Spanish, or Chinese as the default language the characters in the movie will speak. Once the desired language has been highlighted, press the OK key (OK) on the remote to select the language. The orange circle will then move to that language.

Selecting 'Auto' will result in the default audio language being determined from information on the BD/DVD disc.

NOTE: Not all languages are available on all discs.

NOTE: Some discs might not allow the user to select the audio language from the BD-player setup menus. The audio language can then only be selected from the BD or DVD disc's setup menu. (The menu that appears after the disc has been inserted)

Once the desired language has been highlighted, press the OK key (OK) on the remote to set the language. The orange circle will then move to that language. You can then move to another menu item by pressing the left arrow key (◀) on the remote until the center portion of the setup menu is highlighted.



2.2.2 Subtitle Language

To set the player's default subtitle language, press the up/down arrow keys (▲▼) on the remote until the **Subtitle** menu choice is highlighted in the center of the setup menu screen. Then, press the right arrow key (▶) on the remote until the right portion of the setup screen is highlighted.



The up/down arrow keys (▲▼) on the remote can then be used to select English, French, Spanish, or Chinese as the default language for disc subtitles. Selecting 'Auto' will result in the default subtitle language being determined from information on the BD/DVD disc.

NOTE: Not all languages are available on all discs.

NOTE: Some discs might not allow the user to select the audio language from the BD-player setup menus. The audio language can then only be selected from the BD or DVD disc's setup menu. (The menu that appears after the disc has been inserted)



Once the desired language has been highlighted, press the OK key () on the remote to set the language. The orange circle will then move to that language. You can then move to another menu item by pressing the left arrow key () on the remote until the center portion of the setup menu is highlighted.

2.2.3 Menu Language



To set the language that will be displayed when the BD or DVD disc's main menu appears, press the up/down arrow keys () on the remote until the **Menu** choice in the center of the setup screen is highlighted. Then, press the right arrow key () on the remote until the right portion of the setup screen highlighted.

The up/down arrow keys () on the remote can then be used to select English, French, Spanish, or Chinese as the default language for menus that appear after a BD disc is inserted. Selecting 'Auto' will result in the default menu language being determined from information on the BD/DVD disc.



NOTE: Not all languages are available on all discs. Most discs only have one menu language available.

Once the desired language has been highlighted, press the OK key () on the remote to set the language. The orange circle will then move to that language. You can then move to another menu item by pressing the left arrow key () on the remote until the center portion of the setup menu is highlighted.

2.2.4 Setup Menu (OSD) Language

To set the language that will be displayed when the BD player's setup menus, press the up/down arrow keys () on the remote until the **OSD** choice in the center of the setup screen is highlighted. Then, press the right arrow key () on the remote until the right portion of the setup screen is highlighted.

The up/down arrow keys () on the remote can then be used to instantly change the on-screen display to English , French or Spanish.

Once the desired language has been highlighted, press the OK key () on the remote to set the language. The orange circle will then move to that language. You can then move to another menu item by pressing the left arrow key () on the remote until the center portion of the setup menu is highlighted.

2.2.5 Exiting the Language Category

When you are done setting up the BD player's language settings, you may use the left arrow key () on the remote until only the left side of the setup menu is highlighted, and then you can use the up/down arrow keys on the remote to choose another menu category. Alternatively, you can press the <BACK> key on the remote to leave the setup menu.

2.3 DISPLAY MENU CATEGORY

To set the video outputs correctly, press the up/down arrow keys (▲▼) on the remote until the **Display** menu category is highlighted on the *left* portion of the setup menu screen.

A screen similar to the following will appear:

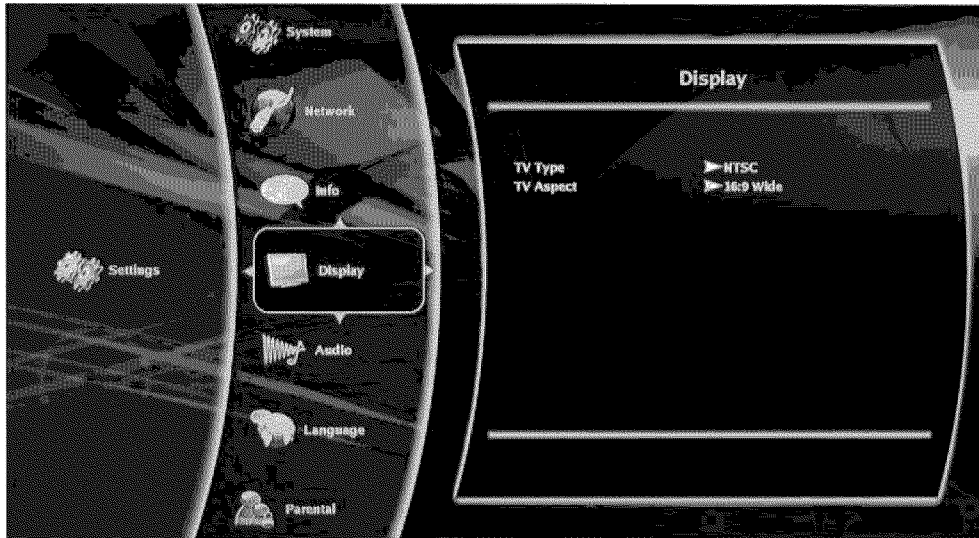

Each of the menu choices above will be explained in the next sections.

2.3.1 TV Type

You can tell the BD player whether to output US/Asia (NTSC) video or Australian/European (PAL) video using this menu item.

To set the BD player's output video format, press the up/down arrow keys (▲▼) on the remote until the **TV Type** choice in the center of the setup screen is highlighted. Then, press the right arrow key (▶) on the remote until the right portion of the setup screen is highlighted.

The up/down arrow keys (▲▼) on the remote can then be used to select NTSC or PAL as the video output format.

NOTE: Incorrectly setting this menu item may result in not being able to see video.
If you can already see the setup menu, **leave this menu item alone!**

Once the desired output format has been highlighted, press the OK key (OK) on the remote to set the format. The orange circle will then move to the highlighted video format. You can then move to another menu item by pressing the left arrow key (◀) on the remote until the centermost portion of the setup menu is highlighted.

2.3.2 TV Aspect

You can use this menu item to tell the BD player whether you have a very rectangular shaped, 16:9-aspect ration television set, or a more traditional, almost square 4:3 aspect-ratio television set.

To inform the BD player of your TV's aspect ratio, press the up/down arrow keys (▲▼) on the remote until the **TV Aspect** choice in the center of the setup menu screen is highlighted. Then, press the right arrow key (▶) on the remote until the right portion of the setup screen is highlighted.

The up/down arrow keys (▲▼) on the remote can then be used to select your TV's aspect ratio.

If your TV has a very rectangular (16:9) aspect ratio, you will need to choose one of the 16:9 aspect ratios (full or pillarboxed).

If your TV has an "old fashioned" (relatively square) (4:3) aspect ratio, you will need to choose one of the 4:3 aspect ratios (letterboxed or pan/scan).

Your preference should be based on whether the disc you will be watching contains a movie in widescreen format, or has been cropped to fit a "standard" 4:3 screen, as well as your individual preference for viewing, as shown in the table below:

Disc Contents	TV Aspect Menu Selection			
	If your TV is 16:9, choose:		If your TV is 4:3, choose:	
	16:9 Full	16:9 Pillarboxed	4:3 Letterboxed	4:3 Pan Scan
Movie in widescreen format	Movie will fill entire screen	No effect- Movie will fill entire screen	Movie will be shown in rectangular "wide" aspect ratio (Horizontal bars will be shown above/below movie)	Center of movie will be shown on TV. Let and right portion of movie contents will not be shown
HD television episodes in widescreen format	Episode will fill entire screen	No effect- Episode will fill entire screen	Episode will be shown in rectangular "wide" aspect ratio (Horizontal bars will be shown above/below movie)	Center of episode will be shown on TV. Let and right portion of episode contents will not be shown
SD (4:3) Television episodes	Episode will be stretched <i>horizontally</i> to fit entire screen	Episode will be shown in center of screen; vertical bars will appear on sides of screen	No effect – Episode will fill entire screen	No effect- Episode will fill entire screen
Cropped Movie (Movie Put on disc in 4:3 Aspect Ratio)	Movie will be stretched <i>horizontally</i> to fit entire screen	Movie will be shown in center of screen; vertical bars will appear on sides of screen	No effect – Cropped movie will fill entire screen	No effect – Cropped movie will fill entire screen

The left/right menu keys can then be used to select the desired aspect ratio. Once the aspect ratio has been selected, the player has been set. You can then move to another menu item.

NOTE: Setting the player for one of the 16:9 settings when connected to a 4:3 TV could result in the inability to see video on your TV.

2.4 AUDIO MENU CATEGORY

To set the digital and analog audio outputs correctly, press the up/down arrow keys (▲▼) on the remote until the **Audio** menu category is highlighted on the *left* portion of the setup menu screen.

A screen similar to the following will appear:

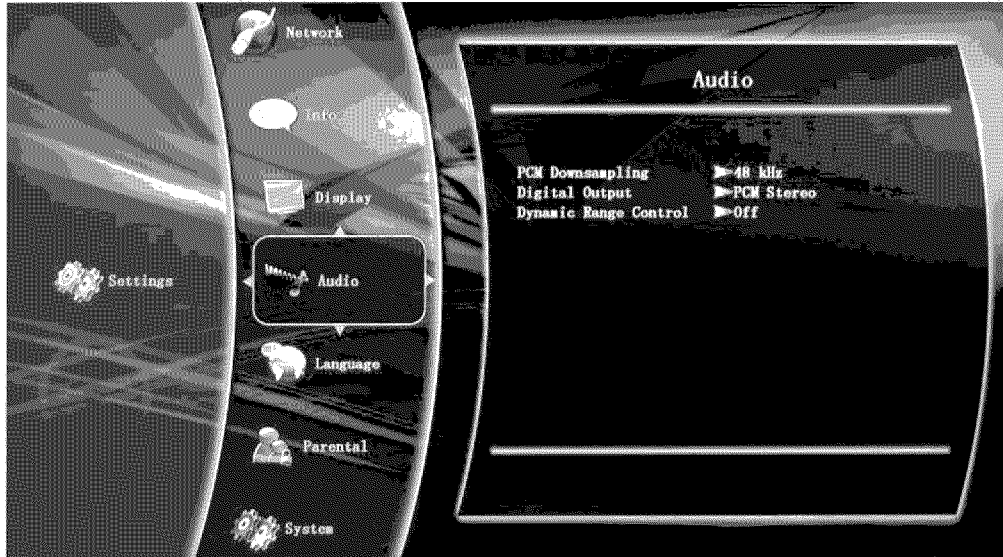

Each of the menu choices above will be explained in the subsequent sections.

2.4.1 Digital Audio - Overview

In order to properly set the BD player for the correct audio output settings, a high-level understanding of the types of audio present on a Blu-Ray or DVD disc is helpful.

First, BD discs typically contain several audio tracks. These include

- the **primary** audio tracks (the movie's soundtrack).
- an (optional) secondary audio tracks (director's commentary, for example), and
- a sound effects track (a unique sound may be associated with individual menu button pushes when playing a "special features" game, for example).

In addition, several different methods are used for representing the audio tracks on a disc. These methods of storing audio data are called codecs, and include:

Blu-ray Disc Player

**Dolby Digital and DTS
(Digital Theater Systems)
Digital Surround**

These formats use “accurate but not identical” compression to encode multichannel (5.1) audio onto a DVD or Blu-Ray disc.

Dolby Digital Plus

This format offers up to 7.1-channel surround sound, and is only available on some DVD and Blu-Ray discs. It uses less compression than its Dolby Digital or DTS counterparts, for a better reproduction of the original movie soundtrack.

Dolby TrueHD and DTS-HD

Both of these formats offer up to 7.1-channel surround sound, and are only available on (some) Blu-Ray discs.

These formats use “accurate and identical” (sometimes referred to as “lossless”) compression to deliver soundtracks that are identical to the movie studio’s original audio master, for the closest possible reproduction of the movie theater experience. **These lossless audio codecs can only be sent out the HDMI output. A compatible HDMI surround receiver is required in order to play these tracks.**

PCM

This storage method is similar to what is found on a music CD. DVDs often have a stereo PCM audio track. Some BD discs also feature multichannel (5.1, 6.1, or 7.1) PCM soundtracks.

Multichannel PCM soundtracks are uncompressed audio that can sometimes exactly match the quality of the studio master. **The multichannel lossless PCM formats are only available on the HDMI output. A compatible HDMI surround receiver is required in order to play these tracks.**

(Stereo PCM can be output over the Coaxial or Optical audio outputs)

A summary of these audio formats is shown in the table below:



Disc Type	Possible Digital Audio Tracks on the disc	BD Player Audio Output
Blu-Ray	Dolby True HD DTS-HD Dolby Digital Plus	HDMI
Blu-Ray and DVD	Dolby Digital DTS PCM (BD – up to 7.1 channels @ 192Khz) PCM (DVD – stereo <u>only</u> , up to 96Khz)	Coaxial or Optical

Regardless of the type of codec used to store the movie’s audio track onto the disc, audio data is always stored on a disc in a digital format. The BD player therefore has digital audio outputs, so that the digital audio soundtracks on the disc can be sent straight to a surround-sound receiver, without any loss in audio quality.

Not all surround-sound receivers are capable of playing back all of the digital audio codes listed above. In addition, some surround sound receivers can play pack PCM data, but the data must be sent to the receiver at a slower rate than what is stored on the Blu-Ray disc.

Because of this, an understanding of your surround-sound receiver's capabilities is required in order to properly set up the digital audio outputs of the BD player.

Now that the various types of digital audio codecs have been explained, the next few menu items will be described in further detail.

Once the desired digital audio output format has been highlighted, press the OK key () on the remote to set the format. The orange circle will then move to the highlighted audio format. You can then move to another menu item by pressing the left arrow key () on the remote until the center portion of the setup menu is highlighted.

2.4.2 Digital Output

If you have read this far, your multichannel (5.1/7.1 channel) audio receiver is connected to the BD player via HDMI.

Set the digital output based on the table below:

	Receiver Capabilities		
	Can decode DTS-HD	Can decode Dolby TrueHD	Can't decode DTS-HD or Dolby TrueHD
I want the highest-fidelity movie soundtrack audio possible	Set to Passthru for discs with DTS-HD soundtracks. Set to DTS re-encode otherwise.	Set to Passthru for discs with Dolby TrueHD soundtracks. Set to DTS re-encode otherwise	Go back to the table in question 5 to decide.
I want to hear the directors commentary on the BD disc --OR-- I want to set this menu item once and then forget it	Set the output to DTS re-encode		

NOTE: To achieve the best audio quality, you must also use the set up menu on the disc to set the highest quality audio track supported by the receiver.

NOTE: Setting the digital output to 'Bitstream HD' means that only the primary digital audio track (the movie soundtrack) will be sent to the sound receiver via the digital outputs.

Director's commentary will not be heard when the digital output is set to "Bitstream HD".

2.4.3 PCM Downsampling

You can use this menu item to tell the BD player whether your surround receiver can handle high-bitrate PCM signals over the Coaxial/Optical interface.

To inform the BD player of your surround sound receiver's PCM capabilities, press the up/down arrow keys (▲▼) on the remote until the **PCM Downsampling** choice in the center of the setup screen is highlighted. Then, press the right arrow key (▶) on the remote until the right portion of the setup screen is highlighted.

The up/down arrow keys (▲▼) on the remote can then be used to select the maximum PCM sample rate output by the BD player.

If you don't have a surround sound receiver connected to the BD player, you should set the PCM downsampling to 48 Khz, and proceed to the next setup menu item. This is true regardless of whether the audio is connected to the TV with HDMI, Coaxial, or the analog stereo outputs.



If you have a surround sound receiver connected to the BD player, and you have connected to the surround receiver via the BD player's Stereo audio outputs, this setting has no effect on the audio going to the analog outputs of the player. Set the PCM downsampling to 48 Khz, and proceed to the next setup menu item.

If you have a surround sound receiver connected to the BD player, and you have connected to the surround receiver via the BD player's HDMI output, this setting has no effect on the audio going to the HDMI output of the player. Set the PCM downsampling to 48 Khz, and proceed to the next setup menu item.

If you have a surround sound receiver connected to the BD player via Coaxial (or Optical), set this menu item to the maximum PCM sampling rate that your surround receiver can accept (48Khz or 96 Khz).

If in doubt, consult your surround receiver's manual or set to 48 KHz.

NOTE: Incorrectly setting the digital audio output's PCM sampling rate may result in unpredictable audio playback.

Once the desired PCM sampling rate has been highlighted, press the OK key () on the remote to set the sampling rate. The orange circle will then move to the highlighted sampling rate. You can then move to another menu item by pressing the left arrow key () on the remote until the center portion of the setup menu is highlighted.



2.4.4 Dynamic Range Control

Dynamic Range Control means that you can allow the BD player to make the loud parts of a movie's audio track quieter than they would be in the theatre, without making the dialog of the actors any quieter.

This would be useful, for instance, when you want to watch a movie in the evening when others might be sleeping.



NOTE: This setup menu item **has no effect** unless:

- Your audio device (TV or audio receiver) is connected to the BD player's analog audio outputs; OR
- you have selected "Bitstream Mixed" or "PCM" in the BD player's audio setup menu.

To tell the BD player whether you want the loud noises in the movie to be quieter, press the up/down arrow keys () on the remote until the **Dynamic Range Control** menu choice in the center of the setup screen is highlighted. Then, press the right arrow key () on the remote until the right portion of the setup screen is highlighted.

The up/down arrow keys () on the remote can then be used to turn dynamic range compression (loud noise quieting) on or off.

Selecting the "Auto" option turns on the Dynamic range control for all BD movie soundtracks *except* Dolby TruHD. If you have selected a TruHD track on the BD disc, the "auto" selection tells the BD player to only turn on dynamic range control if information embedded in the TruHD sound track tells it to do so.

Once the desired choice has been highlighted, press the OK key () on the remote to set the choice. The orange circle will then move to the highlighted choice. You can then move to another menu item by pressing the left arrow key () on the remote until the center portion of the setup menu is highlighted.

2.5 PARENTAL CONTROL

To set the player's parental control settings, from the main setup menu, press the up/down arrow keys (▲▼) on the remote until the **Parental Control** menu choice is highlighted.

Press the 'Select' key on the remote, and the following screen will appear:



Attempting to change any of these items initially will result in the following screen appearing:

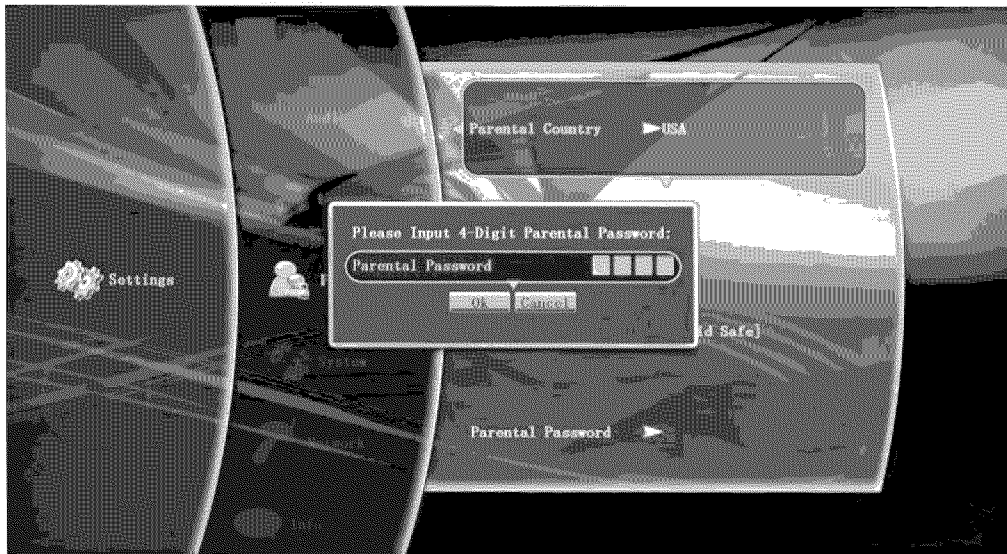

The first time this screen appears, you should enter the default parental password, which is 0000. (This can be changed later). Be advised that as you type these numbers, a "*" will appear on the screen.

Once you are done entering the parental control password, you will be automatically returned to the parental menu.

You can then configure the BD player for various levels of parental control, as described in the next sections.

2.5.1 Parental Country

Use this menu item to tell the BD player what country you are in. Currently this menu item has no effect.

2.5.2 Parental Control

Use this menu item to turn parental control ON or OFF. When turned on, playback of certain discs (controlled by the Parental Level menu item) will be restricted.

2.5.3 Parental Level

Use this menu item to restrict playback of discs encoded with a rating level equal to or higher than the level you set. Parental Control must be turned on for this menu item to be effective.

2.5.4 Parental Password

To change the parental control password, press the up/down arrow keys (▲▼) on the remote until the **Parental Password** menu option in the center of the setup screen is highlighted. Then, press the right arrow key (▶) on the remote until the rightmost portion of the setup screen is highlighted.

Use the up/down arrow keys (▲▼) on the remote until the **User Defined** menu option on the right-hand side of the screen is highlighted, and then press the OK key (OK) on the remote. You will then be prompted with a screen as shown below:



Entry any 4-digit number for the parental password. Once this number has been entered, it must be re-entered any time someone enters the parental setup category and then attempts to make changes.

NOTE: If you forget the parental control password, you must go to the System Setup Menu category, and re-set the player to the factory defaults.

2.6 SYSTEM MENU CATEGORY

From the main setup menu, press the up/down arrow keys (▲▼) on the remote until the **System** menu choice is highlighted, and the following screen will appear:

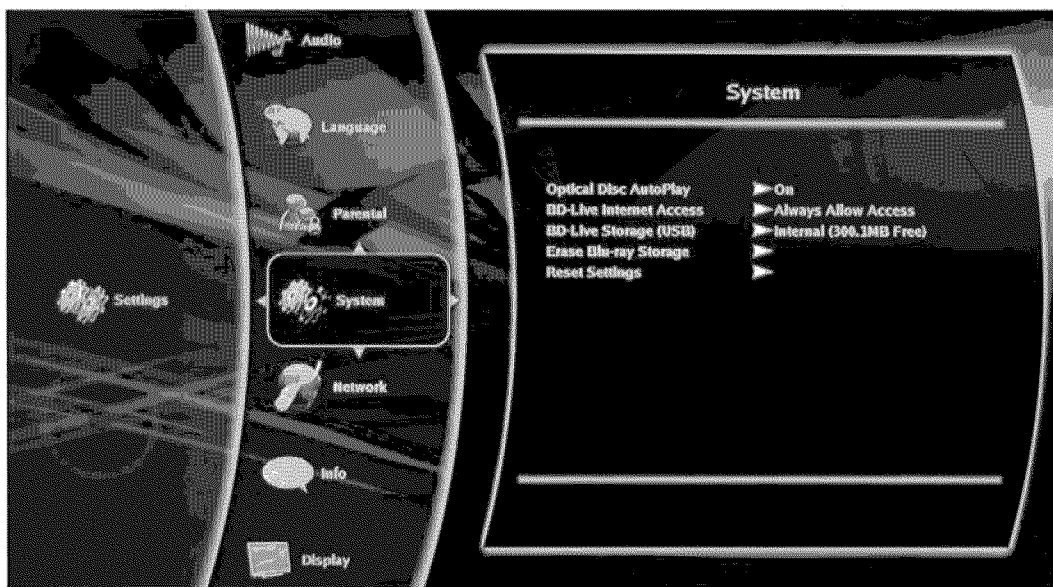

2.6.1 Optical Disc AutoPlay

Highlighting this setup menu selection, and then pressing 'OK', will open/close automation playing after loading disc.

2.6.2 BD-Live Internet Access

Highlighting this setup menu selection, and then pressing 'OK', will choose to open/close INTERNET channel. Connect this product to the movie studios website via the LAN port to access a variety of up-to-date content (e.g. refreshed previews and exclusive special features). You can also enjoy next generation possibilities, such as ringtone/wallpaper downloads, peer-to-peer interactions, live events and gaming activities.

2.6.3 BD-Live Storage(USB)

Choose the memory mode of BD-Live(USB or inner memory).

NOTE: operation of BD-Live: insert the ethernet cable into the ETHERNET of DVD, insert USB or Bluray disc with BD-Live function, then choose the BD-Live function on MENU.

2.6.4 Erase Blu-ray Storage

Highlighting this setup menu selection, and then pressing 'OK', will clear the portion of the BD player's internal memory that is used to store "bookmarks" (which allow discs to resume play after the player has been paused). It also clears any content (New movie trailers, etc) that has been downloaded from the internet.

2.6.5 Reset Settings

Highlighting this setup menu selections, and then pressing 'OK', will clear the portion of the BD player's internal memory that is used to store information from the Setup menu. The BD player will revert to the "factory default" settings.

2.7 Using the USB Port for BD-Live Storage and Media Playback

A USB device provides an additional memory to enjoy media play and BD-Live bonus content.

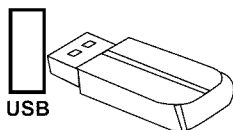

Connect the USB device to the USB jack on this product.

We do not guarantee 100% compatibility with all USB devices.

Note: The USB port can be used for playing media files or for BD-Live storage.

1. Insert your USB device, will show the options as right picture on the top right corner of TV screen:



2. After USB is recognized, you can see MUSIC, PICTURE and MOVIE three formats in the left side of the screen. Press \blacktriangle / \blacktriangledown to select what you want to play then press Ok to select.

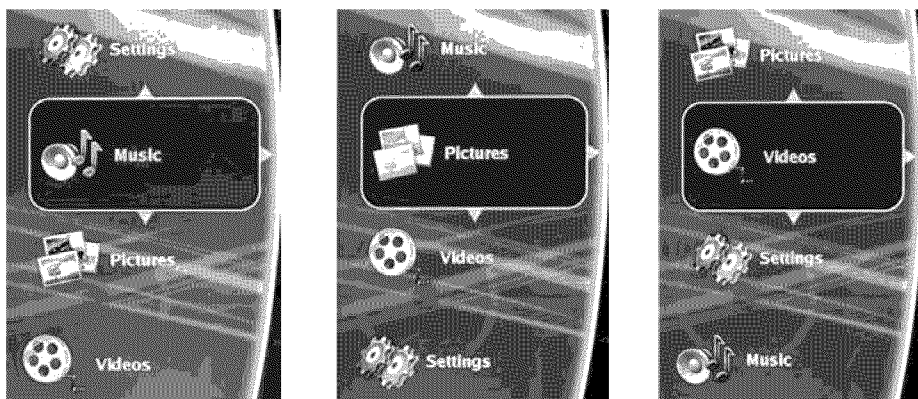

3. If it's the first time for you to see the content in USB, please select USB as showed in picture, then play what you want. You can also add you favorite files into PLAY LIST. You can select the content in the PLAY LIST directly to play next time.

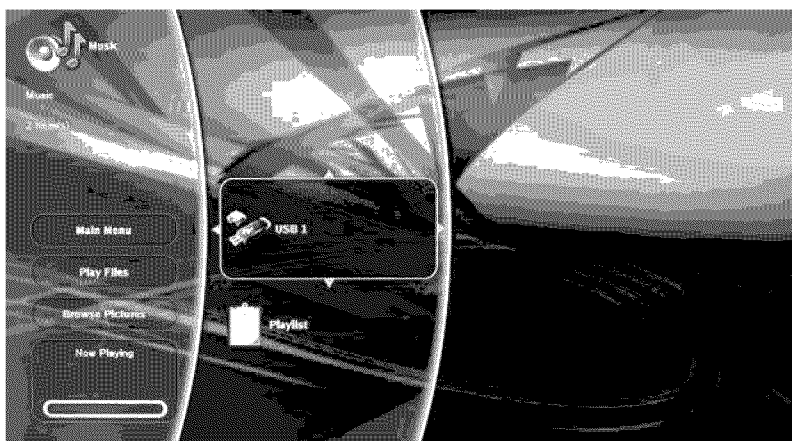

3 PLAYING A BD OR DVD DISC

3.1 STANDARD (OR NORMAL) PLAYBACK OF A BD OR DVD DISC

- 1 Press the STANDBY/ON button on the front panel of the BD player

----- OR -----

Press the power button  on the remote.

- 2 Turn on the TV, and using the TV remote control, select the input type on the TV that is connected via cable to the BD player (HDMI, component, etc)
-
-

- 3 Press OPEN/CLOSE on the front panel of the BD player to open the tray.

----- OR -----

Press the OPEN/CLOSE button  on the BD player remote to open the tray.

The front panel will display OPEN.

- 4 Insert the disc. Press OPEN/CLOSE on the front panel to close the tray.

----- OR -----

Insert the disc. Press the OPEN/CLOSE button  on the BD player remote to close the tray.

The front panel will display CLOSE. The BD player will then determine the type of disc inserted.

If the BD player recognizes the type of disc, it will then display LOADING on the front panel.

- 3a After a brief period of time, Chapter 1 of Title 1 on the disc will begin playback. You may begin watching the disc at this point.

The front panel will display the elapsed time of playback, chapter number, etc.

- 3b** On many BD discs, chapter 1 of title 1 is an advertisement, or preview of upcoming release. If you wish, you may press the "Disc Menu" button on the remote to bring up the main disc menu. From there, you can often use the arrow keys on the remote to select the "Play Movie" menu item.
-
-

- 6** To stop playback, press the PAUSE button **||** on the remote control.

To resume playback after pausing, press either the PAUSE button **||** again, or press the PLAY button **▶**.

- 7** To stop playback, press the STOP button **■** on the remote control.
-
-

- 8** To remove the disc, press OPEN/CLOSE on the front panel of the BD player to open the tray.

----- OR -----

To remove the disc, press the OPEN/CLOSE button **▲** on the BD player remote to open the tray.

The front panel will display **OPEN**.

- 9** Remove the disc. Press OPEN/CLOSE on the front panel to close the tray.

----- OR -----

Remove the disc. Press the OPEN/CLOSE button **▲** on the BD player remote to close the tray.

The front panel will display **CLOSE**. The BD player will then display **NO DISC** to indicate that the tray is empty.

- 10** Press the STANDBY/ON button on the front panel of the BD player to turn it off

----- OR -----

Press the power button **⏻** on the BD player's remote to turn it off.

3.2 FAST FORWARD

When the disk is playing normally, press the forward scan button ►► on the remote to begin fast forward at 2x normal playback speed. Each time the forward scan button is pressed, the playback speed will double. (The actual progression will be 2x fast forward, 4x fast forward, 8x fast forward, 16x fast forward, then back to play).

To resume normal playback, press the play button ► on the remote.

3.3 FAST REVERSE

When the disk is playing normally, press the reverse scan button ◀◀ on the remote to begin fast reverse at 2x normal playback speed. Each time the reverse scan button is pressed, the reverse playback speed will double. (The actual progression will be 2x fast reverse, 4x fast reverse, 8x fast reverse, 16x fast reverse, then back to play).

To resume normal playback, press the play button ► on the remote.

3.4 SKIPPING TO THE NEXT TRACK

When the CD is playing normally, press the skip forward ►| button once to jump to the next track on the disk. The next track will start playing automatically.

3.5 SKIPPING TO THE START OF THE CURRENT TRACK

When the CD is playing normally, press the skip backwards |◀◀ button once to jump to the beginning of the currently playing track. The current track will start playing back (from the beginning) automatically.

3.6 SKIPPING TO A PREVIOUS TRACK

When the CD is playing normally, press the skip backwards |◀◀ button once to jump to the beginning of the currently playing track, **and then press the skip backwards button again** to skip to the beginning of the previous track. The previous track will start playing back (from the beginning) automatically.

3.7 JUMPING DIRECTLY TO A TRACK ON THE DISK

When the CD is playing normally, press the SEARCH button once, and the word TRACK: will appear on the TV screen. After the word TRACK: appears on the screen, enter the number of the track you wish to jump to, and press the OK button on the remote. The track will start playing back (from the beginning) automatically.

3.8 REPEATING A TRACK

When the disk is playing normally, press the REPEAT button on the remote. The words REPEAT OFF will appear on the TV screen. Continue pressing the REPEAT button on the remote until the words REPEAT TRACK appear on the screen.

The track will now continuously loop.

To stop the track from looping, press the REPEAT button on the remote and the words REPEAT OFF appear on the TV screen.

3.9 LOOPING THE ENTIRE CD

When the disk is playing normally, press the REPEAT button on the remote. The words REPEAT OFF will appear on the TV screen. Continue pressing the REPEAT button on the remote until the words REPEAT ALL appear on the screen.

The CD will now continuously loop.

To stop the CD from looping, press the REPEAT button on the remote and the words REPEAT OFF appear on the TV screen.

Trouble shooting

- Do not use other functions that are not mentioned in this user's manual.
- In case a problem occurs with your LCD TV, please take the following steps first.
- If you still have the problem, turn the power off and contact your dealer or an authorized service center.

Problem	Action
The screen does not appear.	Is the power plug pulled out? Insert the power plug. Press the power button of the remote control.
The screen appears too slowly after the power is turned on.	This problem occurs for a brief time in the process of image elimination processing in order to hide temporary screen noise that occurs when the power is turned on. But if the screen does not come after 1 minute contact your dealer or an authorized service center.
Screen is too bright or too dark.	Perform brightness adjustment or Contrast adjustment.
Screen is too large or too small.	Adjust the screen size.
Stripes appear on the screen and it shakes.	Stop using wireless telephones, hair driers and electric drills.
Screen appears, Voice is not heard	<ol style="list-style-type: none"> 1. Press the "MUTE"button. 2. Increase the sound level by pressing volume adjustment button. 3. Check if sound terminal of external input is connected properly. 4. Check if audio cables are connected properly. 5. Select and check the other input. <p>If the sound still does not work and the other channels are the same after you have done as the above, contact your dealer or an authorized service center.</p>
Remote control does not work	<ol style="list-style-type: none"> 1. Check if main power is On. 2. Check that the batteries of the remote controller were loaded properly. 3. Check to see if any obstacle exists between the LCD TV and the remote control , then remove it, if any. 4. If the batteries have no power, replace them with two new batteries.

- This LCD TV is for household use and registered as harmless on electromagnetic waves.
- Therefore, you can use it in every location as well as residential areas.

Specifications

LCD Panel	Panel Size	32" (measured diagonally) TFT LCD
	Brightness	420cd/m ²
	Contrast Ratio	3600:1
BROADCAST SIGNAL SYSTEM		NTSC M + ATSC
ANTENNA INPUT IMPEDANCE		x1
SOUND OUTPUT		8W x 2
Max. Resolution		1920 x1080
Input Connector	VIDEO	1
	YPbPr	2
	AUDIO (L/R)	3
	PC IN	1
	HDMI	2
	RF	1
Output Connector	SPDIF	1
Power Source		AC 100-240V, 50/60HZ
Power Consumption		150W

- The cabinet design and electronics specifications will be modified without prior notice for improving the performance.

VIORE™ LIMITED WARRANTY

FLAT PANEL TELEVISION

This **VIORE** brand Product, as supplied and distributed by **VIORE** and delivered new in the original carton to the original purchaser is warranted by **VIORE** against manufacturing defects in materials and workmanship for a limited warranty period of one (1) year on parts and labor. However, there will be only a 90 day parts and labor limited warranty for commercial use.

This Limited Warranty does not apply to store display products and product sold as a "marked down" special, in "as is" condition, "open box", products missing accessories, no fault found or damaged at time of delivery to **Viore**.

Proof of purchase within one year from date of purchase in the form of a Bill of Sale, Receipt or Receipted Invoice is evidence the Product is within the limited warranty period. The Bill of Sale, Receipt or Receipted Invoice must be presented as a pre-condition to obtaining the limited warranty service.

This limited warranty begins on the original date of purchase, and is valid only on Products purchased through **VIORE** authorized dealers and used in the United States by the original purchaser. To receive warranty service, the purchaser must contact **VIORE** for problem determination and service procedures. Warranty service may only be performed by a duly authorized **VIORE** service center. The original dated bill of sale, receipt or receipted invoice must be presented upon request as proof of purchase to **VIORE** or **VIORE's** authorized service center.

VIORE will repair or if repairs cannot be made, **VIORE** will replace this Product at no charge if the Product is defective as specified in this limited warranty during the limited warranty period. **VIORE** may use new, or remanufactured parts or products to repair or replace the Product at its sole discretion. All replaced parts and Products become the property of **VIORE** and must be returned to **VIORE**. Replacement parts and Products assume the remaining original limited warranty, or ninety (90) days, whichever is longer.

Product freight needs to be prepaid by original purchaser and shipped in either its original packaging or packaging affording an equal degree of protection. **VIORE** shall not be responsible for or obligated to replace damaged goods. If you reside in California and you cannot transport the television due to the size, weight, and method of attachment, **VIORE** will provide transportation for the television to the repair facility. If you reside in a state other than California, you are responsible for the costs of transporting the television to a repair facility.

If the product is received damaged by **VIORE**, it is the responsibility of the consumer to file a claim against the carrier. **VIORE** will only store the damaged product for 30 days and reserves the right, in its sole discretion, to dispose of the damaged product or ship it back to the consumer at consumer's expense after 30 days.

This limited warranty covers manufacturing defects in materials and workmanship encountered in normal, and except to the extent otherwise expressly provided for in this statement, noncommercial use of this product, and shall not apply to the following, including, but not limited to: damage which occurs in shipment; delivery and installation; applications and uses for which this product was not intended; altered product or serial numbers; cosmetic damage or exterior finish; accidents, abuse, neglect, fire, water, lightning or other acts of nature; use of products, equipment, systems, utilities, services, parts, supplies, accessories, applications, installations, repairs, external wiring or connectors not supplied or authorized by **VIORE** which damage this product or result in service problems; incorrect electrical line voltage, fluctuations and surges; customer adjustments and failure to follow operating instructions, cleaning, maintenance and environmental instructions that are covered and prescribed in the instruction book; reception problems and distortion related to noise, echo, interference or other signal transmission and delivery problems; burned-in images. **VIORE** does not warrant uninterrupted or error-free operation of the product.

THERE ARE NO EXPRESS WARRANTIES OTHER THAN THOSE LISTED AND DESCRIBED ABOVE, AND NO WARRANTIES WHETHER EXPRESS OR IMPLIED, INCLUDING, BUT NOT LIMITED TO, ANY IMPLIED WARRANTIES OF MERCHANTABILITY OR FITNESS FOR A PARTICULAR PURPOSE, SHALL APPLY AFTER THE EXPRESS WARRANTY PERIODS STATED ABOVE, AND NO OTHER EXPRESS WARRANTY OR GUARANTY GIVEN BY ANY PERSON, FIRM OR CORPORATION WITH RESPECT TO THIS PRODUCT SHALL BE BINDING ON VIORE. REPAIR OR REPLACEMENT AS PROVIDED UNDER THIS LIMITED WARRANTY IS THE EXCLUSIVE REMEDY OF THE CONSUMER. VIORE SHALL NOT BE LIABLE FOR ANY INCIDENTAL, OR CONSEQUENTIAL DAMAGES FOR BREACH OF ANY EXPRESS OR IMPLIED WARRANTY ON THIS PRODUCT; EXCEPT TO THE EXTENT PROHIBITED BY APPLICABLE LAW, ANY IMPLIED WARRANTY OF MERCHANTABILITY OR FITNESS FOR A PARTICULAR PURPOSE ON THIS PRODUCT IS LIMITED IN DURATION TO THE DURATION OF THIS LIMITED WARRANTY. THIS LIMITED WARRANTY SHALL NOT EXTEND TO ANYONE OTHER THAN THE ORIGINAL PURCHASER OF THIS PRODUCT, IS NONTRANSFERABLE AND STATES YOUR EXCLUSIVE REMEDY.

Some states do not allow limitations on how long an implied warranty lasts, or the exclusion or limitation of incidental or consequential damages, so the above limitations or exclusions may not apply to you. This warranty gives you specific legal rights, and you may also have other rights which vary from state to state. Any provision contained herein which is found contrary to state or local laws shall be deemed null and void and the remaining provisions shall continue in full force and effect.

To obtain warranty service, please contact **VIORE** at:

Phone: 1-877-777-1428
www.viore.com

