

HOOVER®

Bagless Upright

***Thank you for
your purchase!***

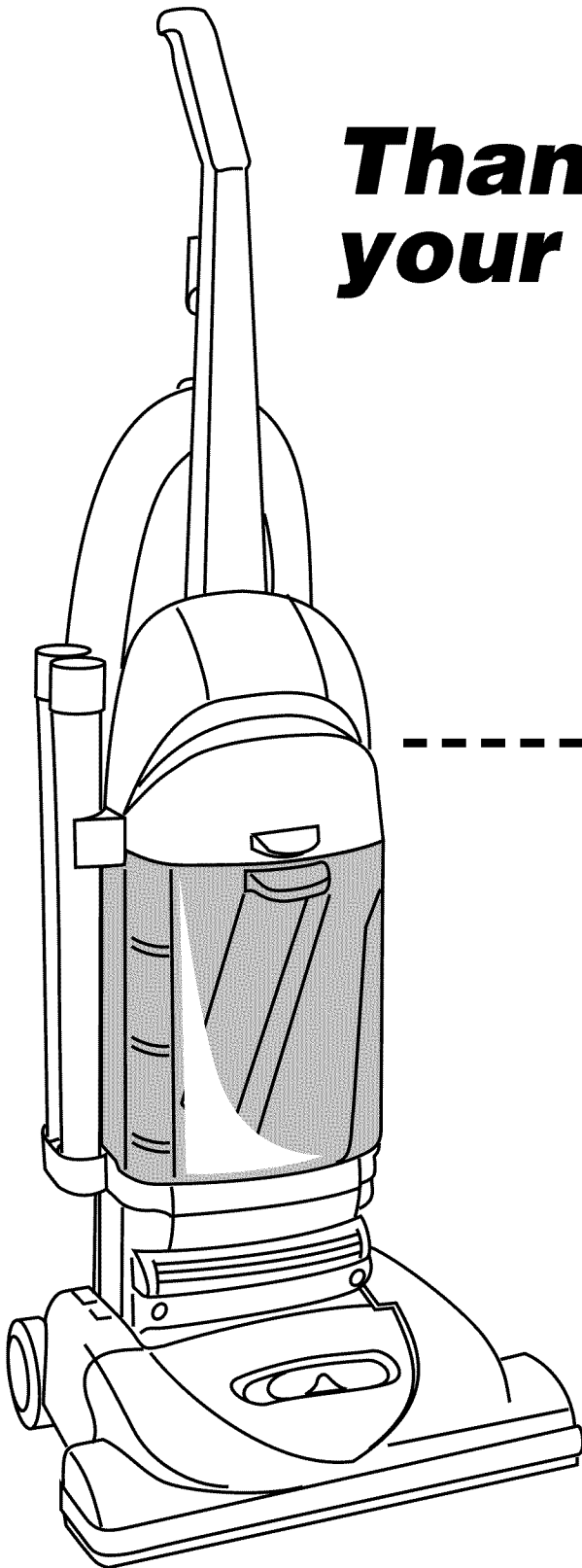

Owner's Manual

ENGLISH → pp. 1-14

ESPAÑOL → pág. 15-22

FRANÇAIS → p. 23-30



This product was designed for
easy assembly (see page 3)

Review this manual before operating cleaner

Thank you for choosing a HOOVER product.

Please enter the COMPLETE model and serial numbers in the spaces provided. The numbers are located on the bottom of your cleaner.

Model _____

Serial number _____

Hint: Attach your sales receipt to this owner's manual. Verification of date of purchase may be required for warranty service of your HOOVER product.

Be sure to fill out and return the product registration card included with your cleaner (see back cover).

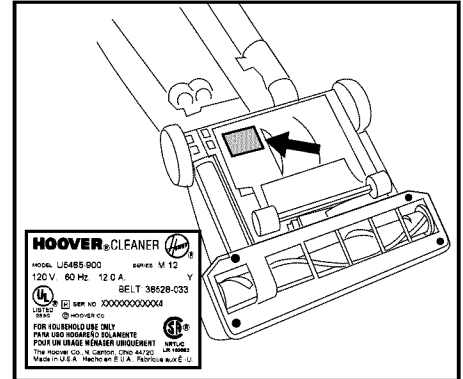

Contents

Assembling Cleaner	3-4
How to use	5
Cleaner Description	5
Cleaning Tools	7-8
If You Have a Problem	13
Clearing Blockages	13
Important Safeguards	2
Maintenance	
Authorized Service	12
Cleaning Filters	9-10
Emptying Dirt Cup	8
Lubrication	12
Replacing Agitator Brush Roll	12
Replacing Belt	11
Replacing Headlight	10-11
Thermal Protector	12
Warranty	14

Important Safeguards

When using an electrical appliance, always follow basic precautions, including the following:

READ ALL INSTRUCTIONS BEFORE USING THIS APPLIANCE

Warning:

To reduce the risk of fire, electric shock, or injury:

- Do not use outdoors or on wet surfaces.
- Close supervision is necessary when any appliance is used by or near children. Do not allow vacuum cleaner to be used as a toy or to run unattended at any time.
- Keep hair, loose clothing, fingers, feet and all parts of body away from openings, rotating agitator and other moving parts. Do not operate cleaner in bare feet or when wearing open toe shoes or sandals.
- Do not pick up anything that is burning or smoking, such as cigarettes, matches, or hot ashes.
- Do not use to pick up flammable or combustible materials such as gasoline or fine wood sandings or use in areas where they may be present.
- Avoid picking up hard, sharp objects with the cleaner. They may damage the cleaner.
- Always turn off this appliance before connecting or disconnecting hose.
- Do not use without dirt cup or filters in place. Empty dirt cup and clean filters frequently when picking up very fine materials such as powder.
- Use extra care when cleaning on stairs.
- Do not put any object into openings. Do not use with any opening blocked; keep free of dust, lint, hair, or anything that may reduce air flow.
- Do not pull or carry by cord, use cord as a handle, close door on cord or pull cord around sharp edges or corners. Do not run appliance over cord. Keep cord away from heated surfaces.
- Always disconnect cord from electrical outlet before servicing the cleaner.
- Unplug cleaner when not in use. Turn off all controls before unplugging.
- Do not unplug by pulling on cord. To unplug, grasp the plug, not the cord. Never handle plug or appliance with wet hands.
- The use of an extension cord is not recommended.
- Do not use with damaged cord or plug. If appliance is not working as it should, has been dropped, damaged, left outdoors, or dropped into water, take it to a Hoover Factory Service Center or Authorized Hoover Warranty Service Dealer (Depot).
- Use vacuum cleaner only for its intended use as described in the instructions. Use only attachments recommended by The Hoover Company; others may cause hazards.



© 2002 The Hoover Company
www.hoover.com

Save these instructions!

If you need any assistance:

Visit our website at www.hoover.com. Click on the "Service" button to find the service outlet nearest you OR

Call **1-800-944-9200** for an automated referral of service outlet locations (U.S. only) OR

Call 1-330-499-9499 to speak with a representative in our Consumer Response Center.

Please do not return this product to the store.

1. Cleaner Assembly

Carton contents

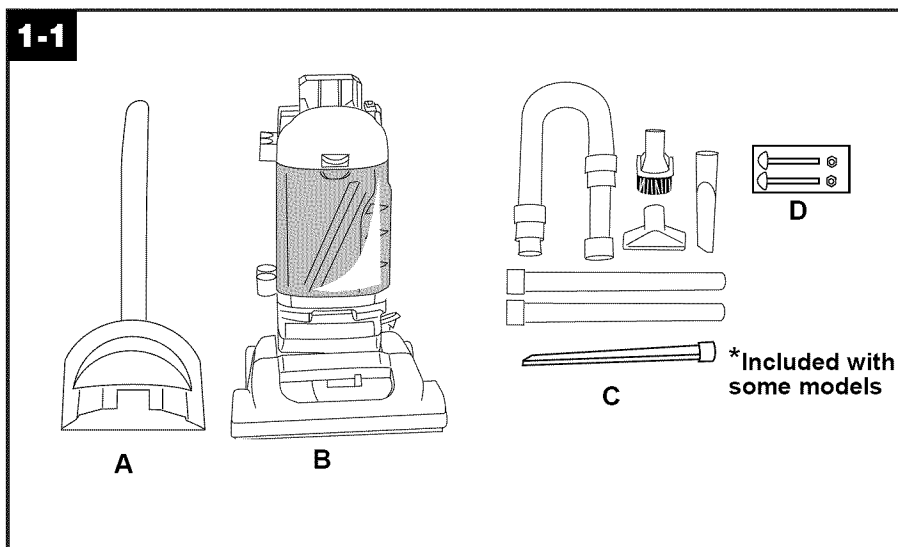

Empty carton. Find the parts shown before disposing of packing materials.

A. Handle section

B. Cleaner body

C. Hose, cleaning tools and wands
(*some models include a crevice wand)

D. Handle bolts and nuts packet (in bag with owner's manual)

Attach handle

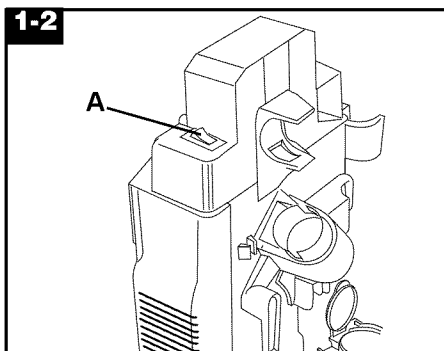

Remove tape and remove dirt cup from cleaner body.
Switch (A) should be in OFF position.

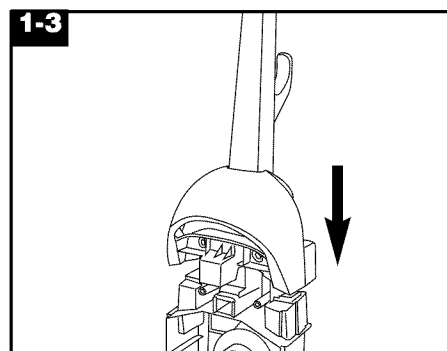

Slide handle onto cleaner body.

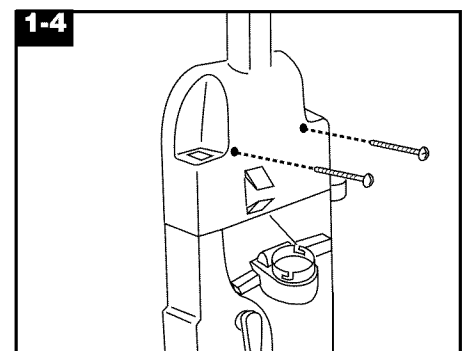

Push bolts into holes on back of handle.

Continued →

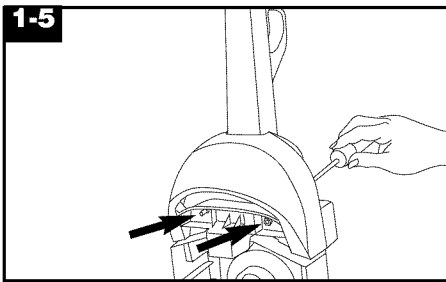

Place nuts in recessed areas on front of handle. Hold each nut in place while tightening each bolt securely with a Phillips screw driver.

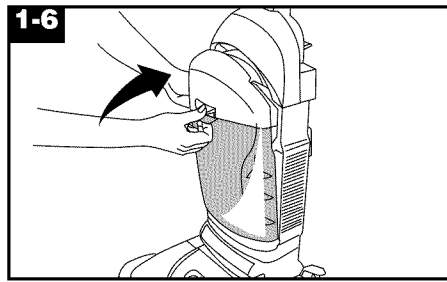

Place bottom of cup into cleaner. Pivot cup and snap in place.

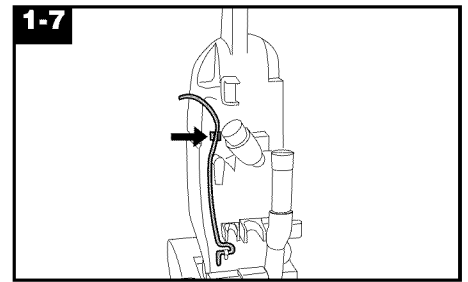

Position cord on back of cleaner as shown and press cord into clip.

Attach hose

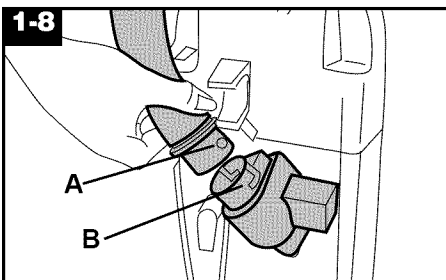

Align end of hose with projections (A) over slots (B) in dirt duct.

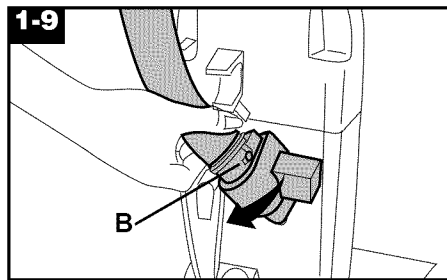

Slide hose into duct (B) and twist hose to lock it into place.

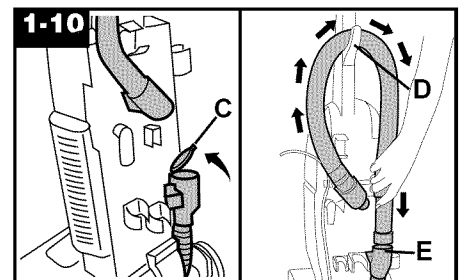

Lift hose tube cover (C). Position hose over hose hook (D) and into hose tube (E).

Position tools

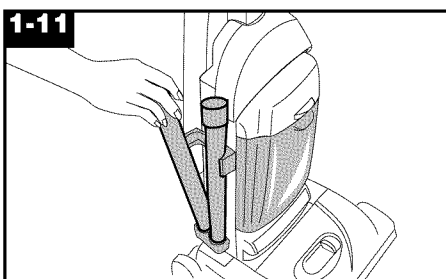

Place smaller unridged end of wand into bottom of rack. Snap wand into clip. Repeat with other wand.

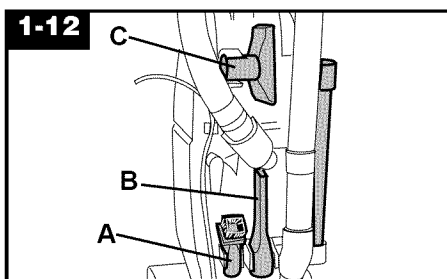

Snap ends of dusting brush (A), crevice tool (B) and furniture nozzle (C) into clips as shown.

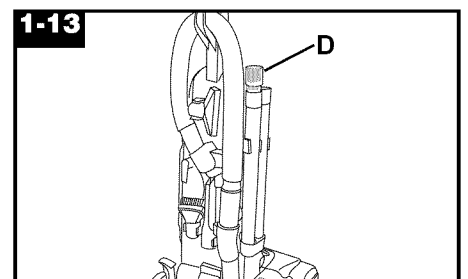

Some models include a long crevice wand (D) instead of the short crevice tool. The crevice wand is packed inside one of the extension wands. Place it inside a wand for storage on the cleaner as well.

2. How to use

Cleaner description

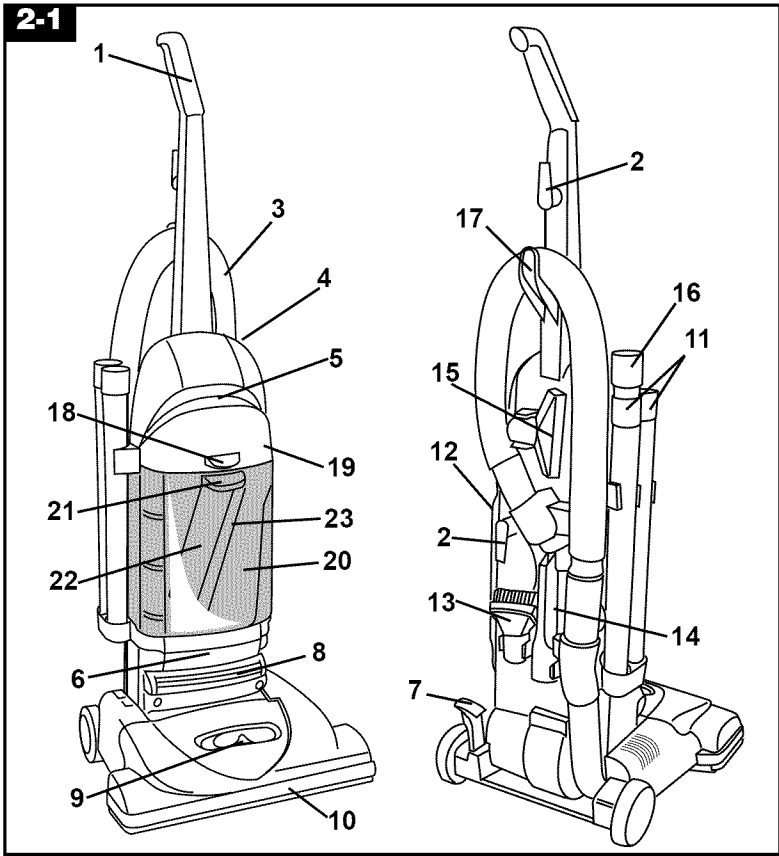

- 1. Handle
- 2. Cord hooks: wrap cord around hooks for storage. The top hook rotates right or left for easy cord release.
- 3. Hose
- 4. ON/OFF switch: located on left rear corner of cleaner body
- 5. Carrying handle
- 6. Stair cleaning handle: located on lower edge of dirt cup.
- 7. Handle release lever: step on lever to lower handle to operating or low positions.
- 8. Headlight
- 9. Nozzle control knob: slide knob to correct setting for height of carpet being cleaned.
- 10. Furniture guard: helps prevent cleaner from marking furniture.
- 11. Wands
- 12. Final filter exhaust
- 13. Dusting brush
- 14. Crevice tool*
- 15. Furniture nozzle
- 16. Long crevice wand*: stores inside wand
- 17. Hose hook
- 18. Dirt cup latch
- 19. Dirt cup lid
- 20. Dirt cup
- 21. Dirt cup handle
- 22. Main filter (inside cup)
- 23. Pre-filter assembly (inside cup)

*Some models only

Operate cleaner only at voltage specified on data plate on bottom of cleaner.
This cleaner is intended for household use.

Polarized plug

To reduce the risk of electric shock, this appliance has a polarized plug (one blade is wider than the other). This plug will fit in a polarized outlet only one way. If the plug does not fit fully in the outlet, reverse the plug. If it still does not fit, contact a qualified electrician to install the proper outlet. Do not change the plug in any way.

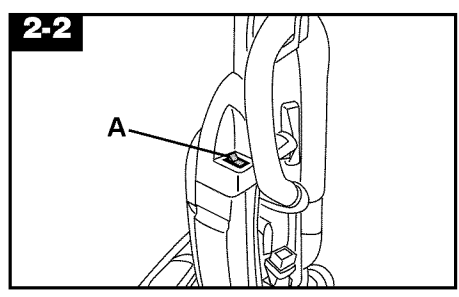

ON/OFF switch

Plug cord into electrical outlet.
To turn cleaner ON, push switch (A) toward front of cleaner.
To turn cleaner OFF, push toward back of cleaner.

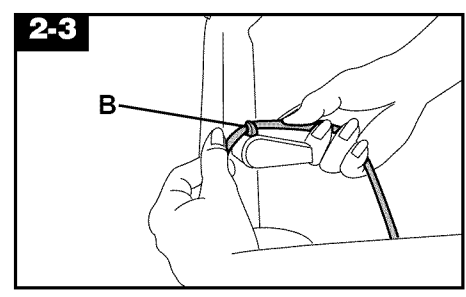

Cord clip

To help keep the cord out of the way while vacuuming, position cord down into cord clip (B) located between top cord hook and handle.

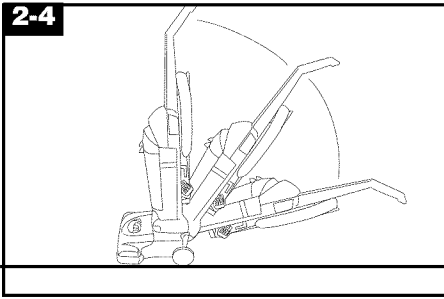

Handle positions

The handle of your cleaner has three positions; **upright** for storage and when using cleaning tools; **operating position** for general operation on carpet and floors; **low** for reaching under low furniture. Step on handle release lever to lower handle.

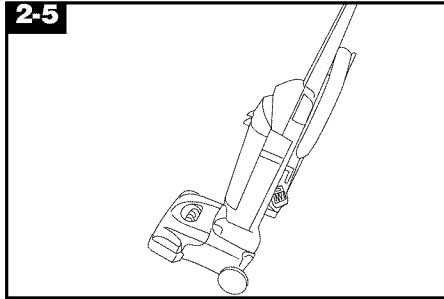

Transporting cleaner

Put handle in upright position. Tilt cleaner back on rear wheels. Push forward.

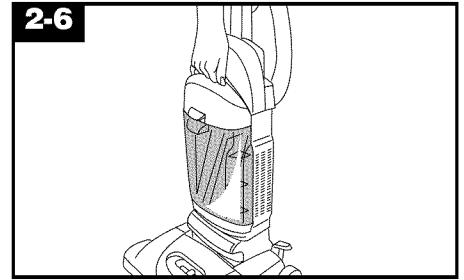

Carrying handle

Use the carrying handle to lift the cleaner.

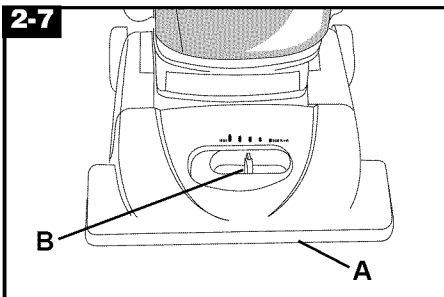

Carpet height adjustment

The cleaning of carpet and rugs takes place at the nozzle (A).

When it is necessary to raise and lower the nozzle for various carpet pile heights, slide the nozzle control knob (B) to the desired setting.

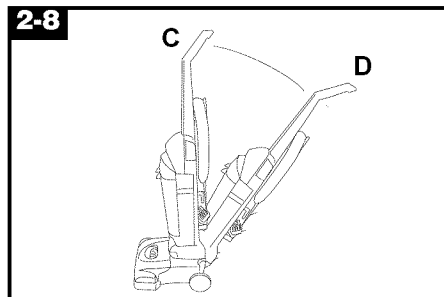

Handle position

For ease in sliding knob, place handle in the upright position (C).

The nozzle will not move into the adjusted position until the cleaner handle is lowered to the operating position (D).

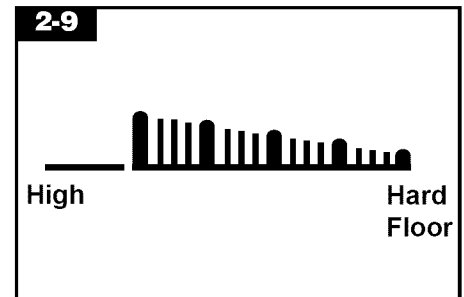

Settings

For maximum cleaning performance, the following carpet height settings are recommended.

- **Lowest setting:** for all types of carpet and hard floors.

Note: If the cleaner is difficult to push, slide knob to the next higher setting.

- **Higher settings:** for very deep pile carpet where easier pushing effort is desired, while maintaining good cleaning performance.

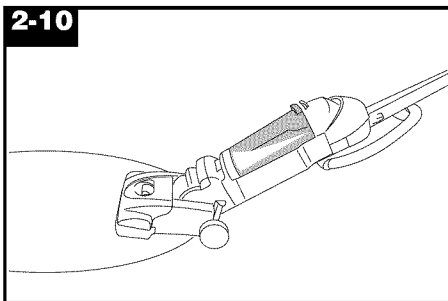

Cleaning lightweight flexible rugs

Stand on one end of rug and move cleaner toward other end or edge. Before reaching edge, push down on handle. This will lift up the nozzle (front of cleaner) as shown and will prevent rug from clinging to cleaner. Continue to lift up nozzle so that when you have reached the edge, it is completely off the rug. Move cleaner back to start again, lower nozzle, and use only forward strokes.

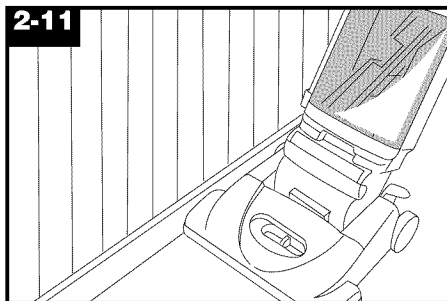

Edge cleaning

Edge cleaning is provided on both sides of the nozzle to remove dirt in carpet near baseboards and furniture.

Guide either side of nozzle parallel to edge of carpet or furniture.

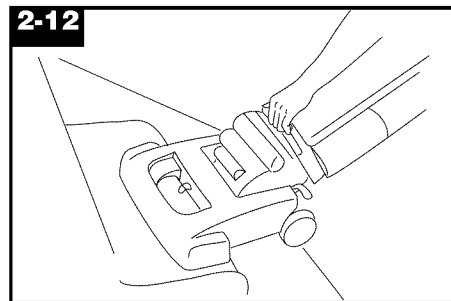

Stair cleaning

A stair cleaning handle has been designed for ease in using your cleaner on stairs. With handle in operating position, place fingers under edge of stair cleaning handle and guide cleaner with other hand on upper handle.

As an alternative, you may use the hose and furniture nozzle for stair cleaning. Clean from bottom to top.

When using cleaning tools, the agitator will continue to rotate.

CAUTION: To avoid personal injury or unnecessary wear to carpet, and to prevent the cleaner from falling, always place it at the bottom of the stairs.

Cleaning tools

Tools allow for cleaning surfaces above the floor and for reaching hard to clean areas.

The cleaner is ready for tool use when handle is in upright position.

CAUTION: Agitator continues to rotate while cleaner handle is in upright position. Avoid tipping cleaner or setting it on furniture, fringed area rugs or carpeted stairs during tool use.

How to clean tools

To clean the hose, wipe off dirt with a cloth dampened in a mild detergent. Rinse with a damp cloth.

Cleaning tools may be washed in warm water with a detergent. Rinse and air dry before using.

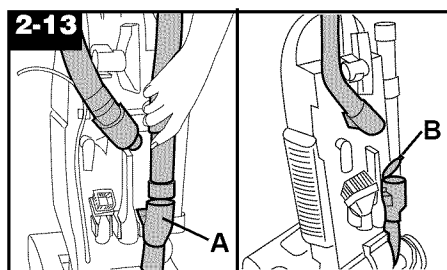

Remove hose

When using cleaning tools, **cleaner handle should be in the upright position. Also, turn cleaner OFF before disconnecting and connecting hose to hose tube (A).**

To use hose, lift hose end as shown.

Lower cover (B) onto hose tube. When you are finished cleaning with the tools, **be sure to lift cover from hose tube and reposition hose end into tube.**

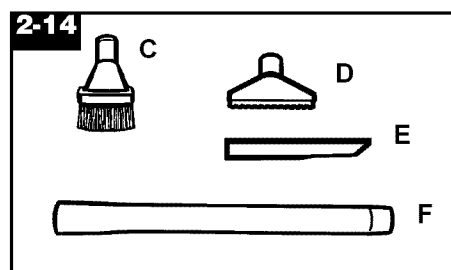

Select proper tool

C. Dusting brush may be used for carved furniture, table tops, books, lamps, lighting fixtures, venetian blinds, baseboards, shutters, and registers.

D. Furniture nozzle may be used for upholstered furniture, draperies, mattresses, clothing, automobile interiors, and carpeted stairs.

E. Crevice tool may be used in tight spaces, corners and along edges in such places as dresser drawers, upholstered furniture, stairs and baseboards.

F. Extension wands are used to give extra length to your hose. Use it with any of the above tools.

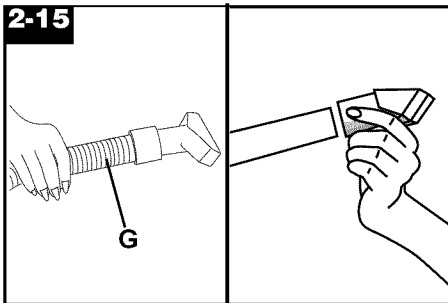

Attach wand and tools

Attach tool or wand to the hose (G) by pushing it firmly into hose.

Attach second wand or tool to the wand in the same manner.

Twist wand or tool slightly to tighten or loosen the connection.

Extra reach hose

(available at additional cost)

The extra reach hose provides you with a 20 foot reach to allow easier cleaning of stairs and hard to reach places. Follow the steps below for attaching and detaching hose.

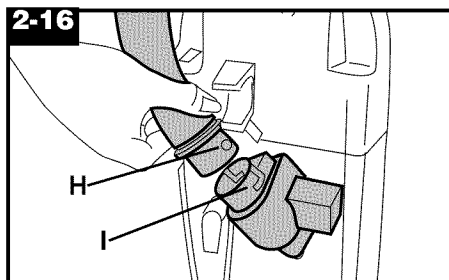

Push ON/OFF switch to OFF position.

Remove regular hose from cleaner.

Align end of extra reach hose with projections (H) over slots (I) in dirt duct.

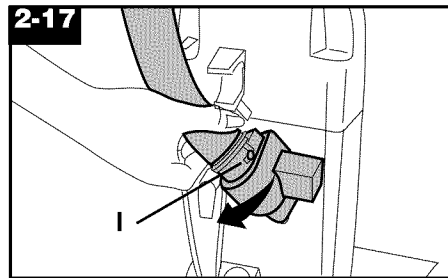

Slide hose into slots (I) and twist hose to lock it into place.

To detach hose, reverse procedure.

Attach wands or tools to the other end of hose.

3. Maintenance

Familiarize yourself with these home maintenance tasks as proper use and care of your cleaner will ensure continued cleaning effectiveness.

Dirt cup

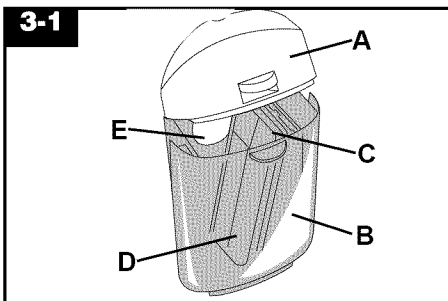

The dirt cup assembly consists of the following parts:

Lid (A)

Dirt Cup (B)

Pre-filter Assembly (C)

Main Filter (D) (*behind pre-filter*)

Dirt Opening (E)

While the cleaner is in operation, the pre-filter assembly screen will stop larger debris from entering the main filter chamber. This larger debris will be seen collecting in the left side of the dirt cup. The main filter will collect fine particles that have passed through the pre-filter assembly screen.

When to empty

It is recommended that the dirt cup be emptied before the dirt reaches the dirt opening on back of dirt cup (Fig. 3-1) or after every use if preferred.

CAUTION: Very fine materials, such as face powder or cornstarch, may seal the filter and cause loss of suction. When using the cleaner for this type of dust, empty the cup and clean the filters often.

How to empty

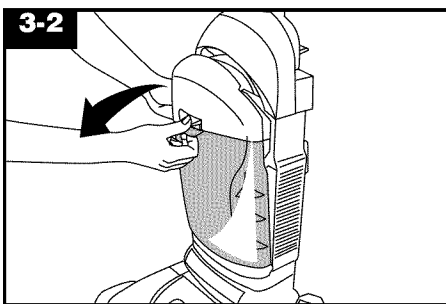

Disconnect cleaner from electrical outlet. Do not use the cleaner without dirt cup or filters in place.

Remove cup - Squeeze dirt cup latch. Pull cup forward.

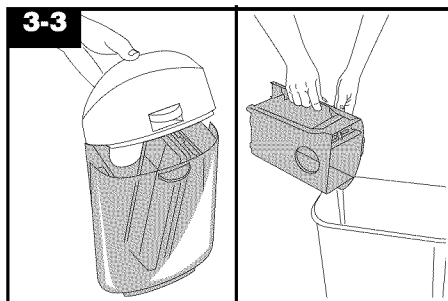

Empty cup - Remove lid.

Note: It is not necessary to remove the main filter or the pre-filter assembly to empty the dirt cup.

Tap side of cup until no more dust particles fall from the main filter.

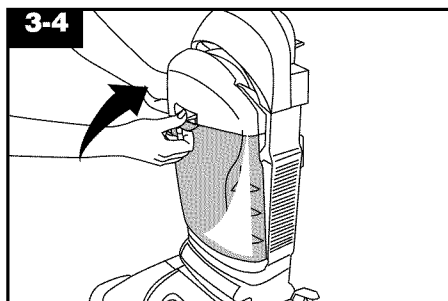

Replace cup - Replace dirt cup lid.

Place bottom of cup into cleaner. Pivot cup and snap into place.

Filter assembly

How to clean filter assembly

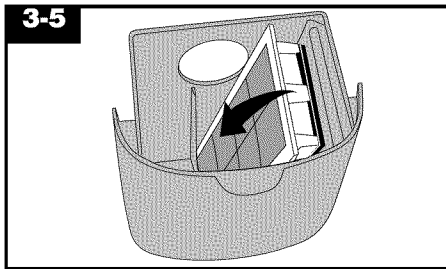

Remove dirt cup and dirt cup lid as described in "How to empty dirt cup".
Pivot pre-filter assembly toward center of cup.

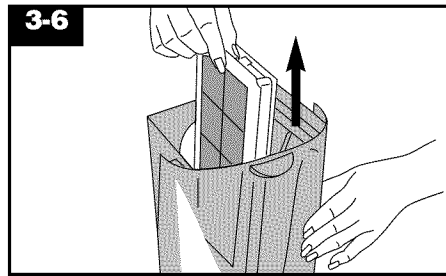

Pull up on pre-filter assembly. Slide it out of cup.

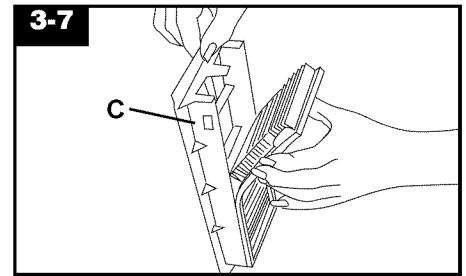

Remove main filter from pre-filter assembly.

The screen (C) can be cleaned with a soft brush or rinsed with water.

Do not rinse or wash the main filter.

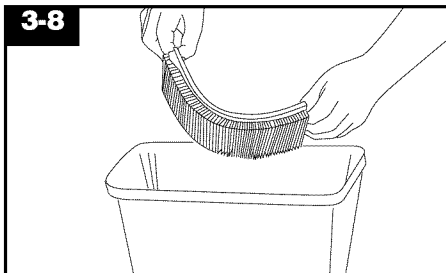

Bend filter to open pleats.
Tap edges of filter until dust particles stop falling from filter.
Do not tap the soft, pleated part of the filter. It could damage the filter.

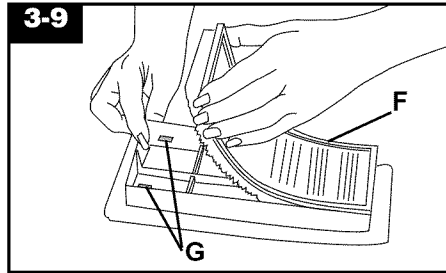

Lay filter on top of pre-filter. Make sure all filter pleats are inside the edges of the pre-filter. Press on filter gasket (F) until 4 tabs (G) (2 on either side of filter) are set in the slots (H) on the pre-filter.
Be careful not to press the filter gasket below the pre-filter edge.

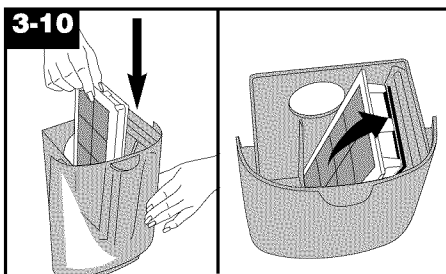

Slide pre-filter assembly all the way to bottom of cup.
Pivot pre-filter assembly and snap in place.
Replace dirt cup lid.

If lid will not close completely, the pre-filter assembly is not positioned correctly.

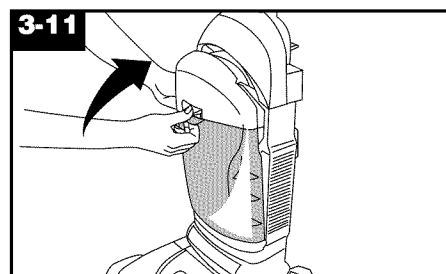

Replace dirt cup.

Secondary and final filters

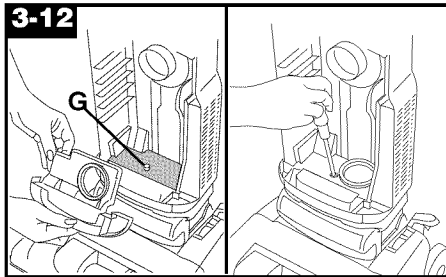

Cleaning secondary filter

Disconnect cleaner from electrical outlet.

The **secondary filter (G)**, located underneath the retainer in the bottom of cleaner cavity, protects the motor from dirt particles.

If filter becomes dirty, remove dirt cup (Fig. 3-2). Remove screw and pull retainer out. Lift out filter.

Hand wash filter in cold water with mild detergent, then air dry.

Reposition dry filter, retainer and screw. Replace dirt cup.

Should you want to replace this filter, ask for **HOOVER part No. 38765019**.

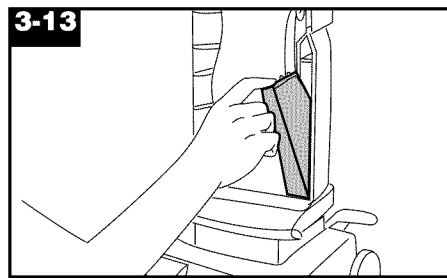

Cleaning final filter

The **final filter** assists in returning clean air to the room.

To remove this filter when it becomes dirty, remove dirt cup and pull down top of filter.

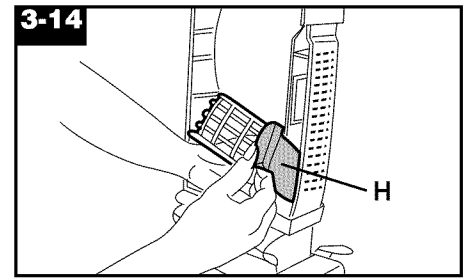

Removing and replacing filter

Lift out filter (H) and hand wash it in cold water with mild detergent.

Let filter air dry and reposition it on the side of cleaner.

Reposition dirt cup.

Should you want to replace this filter, ask for **HOOVER part No. 43613026**.

Do not operate cleaner without any of the filters in place.

Check agitator shield

Because your cleaner picks up so well, we strongly recommend you check for debris accumulation under the agitator shield each time you clean the filters.

Removing debris under the shield will help maintain your cleaner's excellent pick up and suction. Remove debris as follows:

1. Disconnect cleaner from electrical outlet.
2. Check for dirt accumulation by removing bottom plate (Fig. 3-18), removing agitator (Fig. 3-19), and lifting agitator shield (Fig. 3-22).
3. Remove any debris and replace shield, agitator and bottom plate (Figs. 3-22 to 3-24).

Headlight replacement

What to buy

This cleaner uses a 12 volt, wedge base type 912 bulb, **HOOVER part No. 27313101**.

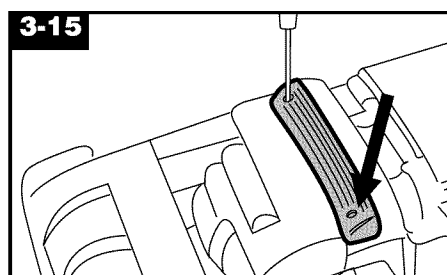

Remove lens - Disconnect cleaner from electrical outlet.

Using a screwdriver, remove the two screws as shown and lift off lens.

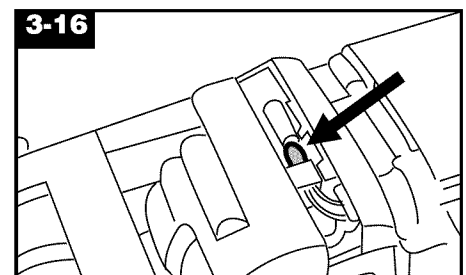

Install bulb - Pull old bulb straight out of socket. Push new bulb straight into socket until locked in place

Excessive force is not required.

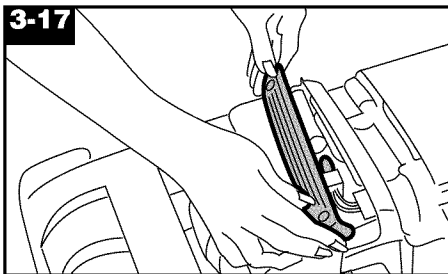

3-17
Replace lens - Reposition lens and secure with the two screws.

Belt replacement

The belt on your Hoover cleaner causes the agitator to rotate and is important for the effective operation of the cleaner. The belt is located under the bottom plate of the cleaner and should be checked from time to time to be sure it is in good condition.

When to replace

Disconnect cleaner from electrical outlet.

To check belt, remove bottom plate as shown in "How to replace". Replace belt if it is stretched, cut or broken.

What to buy

To assure effective operation, use only genuine HOOVER belts with your cleaner. When purchasing a new belt, ask for **HOOVER part No. 38528033** (belt package part number 40201160).

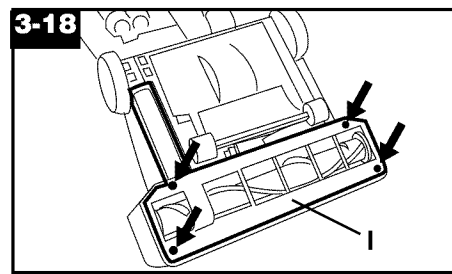

How to replace

Disconnect cleaner from electrical outlet.

Remove bottom plate

Place handle in low position and turn cleaner over so bottom side is up.

Remove the 4 screws as shown with a Phillips screwdriver.

Lift off bottom plate (I).

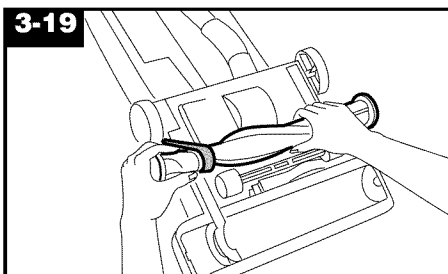

Remove agitator brush roll

Remove agitator and used belt. Discard used belt.

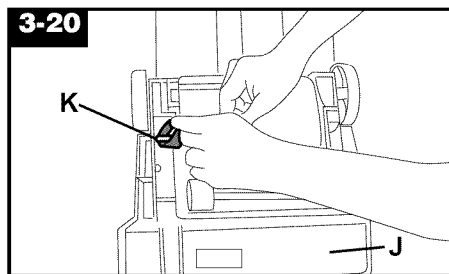

Install new belt

With lettering on outside of belt and positioned as shown in box on (J), slide new belt over motor pulley (K).

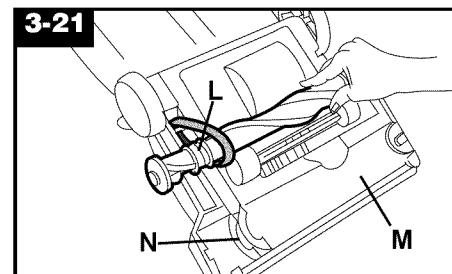

Replace agitator brush roll

Insert agitator through belt and place belt in belt guide (L) on agitator.

Should the agitator shield (M) become dislodged while replacing the belt or the agitator, reposition it as shown noting the placement of its belt guide (N).

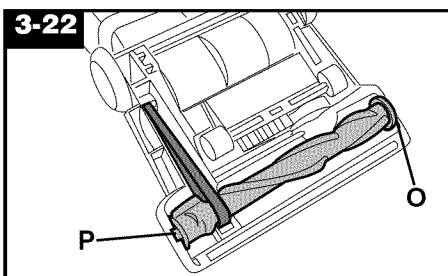

Secure agitator

Grasp agitator firmly and fit it into position by first sliding end opposite the belt into the rectangular slot (O) on side of cleaner.

Pull other side of agitator (P) into place. Turn agitator making sure belt is not pinched between agitator and agitator shield.

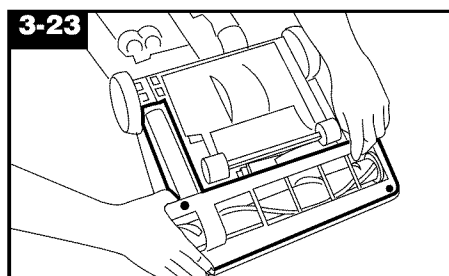

Replace bottom plate

Reposition bottom plate and 4 Phillips head screws. Tighten screws securely.

The agitator brush roll When to replace

When agitator brushes are worn, the agitator should be replaced.

To check condition of brushes, **disconnect cleaner from electrical outlet.** Move edge of a card across bottom plate while turning agitator. To maintain cleaning effectiveness, replace agitator if brushes do not touch card.

What to buy

Your cleaner requires either a 13" or 15" agitator. When purchasing a new agitator, ask for one of the following:

13" - **HOOVER part No. 48414110**

15" - **HOOVER part No. 48414115.**

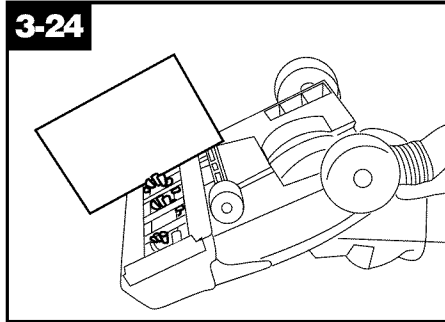

How to replace

Disconnect cleaner from electrical outlet.

Remove bottom plate, belt and agitator following directions in "The belt" section beginning with Fig. 3-18.

Discard old agitator.

Continue following the directions in "The belt" section to reposition belt, new agitator and bottom plate.

Lubrication

The motor is equipped with bearings that contain sufficient lubrication for the life of the motor. The addition of lubricant could cause damage. **Therefore, do not add lubricant to motor bearings.**

The agitator brush roll is equipped with two ball bearings that should be lubricated periodically by a Hoover Factory Service Center or an Authorized Hoover Warranty Service Dealer (Depot).

Thermal protector

An internal thermal protector has been designed into your cleaner to protect it from overheating.

When the thermal protector activates, the cleaner will stop running. If this happens, proceed as follows:

1. Turn the cleaner OFF and disconnect it from the electrical outlet.
2. Check secondary and final filters for dirt accumulation.
3. Refer to "Clearing blockages" section.
4. **When cleaner is unplugged and the motor cools for 30 minutes,** the thermal protector automatically resets and cleaning may continue.

If the thermal protector continues to activate after following the above steps, your cleaner may need servicing (see "Service" section).

Service

To obtain approved HOOVER service and genuine HOOVER parts, locate the nearest **Hoover Factory Service Center or Authorized Hoover Warranty Service Dealer (Depot)** by:

- checking the Yellow Pages under "Vacuum Cleaners - Household" OR -
- checking the list of Factory Service Centers provided with this cleaner OR -
- checking the Service section of The Hoover Company on-line at **www.hoover.com** OR -
- calling **1-800-944-9200** for an automated referral of authorized service outlet locations (U.S. only).

Do not send your cleaner to The Hoover Company in North Canton for service, this will only result in delay.

If further assistance is needed, contact The Hoover Company Consumer Response Center, North Canton, Ohio 44720, Phone: 330-499-9499.

In Canada, contact Hoover Canada, Burlington, Ontario L7R 4A8, Phone: 1-800-263-6376.

Always identify your cleaner by the **complete** model number when requesting information or ordering parts. (The model number appears on the bottom of the cleaner.)

Hoover cleaning performance

This Hoover Cleaning Performance System is for comparing the relative progressive performance of **Hoover uprights only** and not for comparison with any other brands. The majority of this rating is based upon the American Society for Testing and Materials (ASTM) Carpet Cleaning Effectiveness Test (ASTM Test F608). Other performance factors include Hose Power (ASTM Test F558), Surface Litter Cleaning, Hard Floor Cleaning, Edge Cleaning, Cleaning Width, and Air Filtration.

4. If you have a problem

If a minor problem occurs, it usually can be solved quite easily when the cause is found by using the check list below.

Problem: Cleaner won't run

Possible cause

Possible solution

- **Not firmly plugged in**
- Plug unit in firmly
- **No voltage in wall plug**
- Check fuse or breaker
- **Blown fuse or tripped breaker**
- Replace fuse or reset breaker
- **Thermal protector activated**
- Allow cleaner to cool for 30 minutes (this will reset the thermal protector) (see pg. 12).

Problem: Cleaner won't pick up

Possible cause

Possible solution

- **Broken or worn belt**
- Replace belt
- **Agitator brush roll worn**
- Replace brush roll
- **Dirt cup full**
- Empty cup
- **Incorrect carpet height setting**
- Move nozzle control knob to lower setting
- **Blockage in air flow passage**
- Clear blockage
- **Main filter clogged**
- Clean main filter by either tapping the side of the dirt cup or removing the filter as described in the "Filter assembly" section
- **Pre-filter clogged**
- Clean pre-filter as described in "Filter assembly" section
- **Dirt cup not properly installed**
- Position dirt cup properly and snap in place (Fig. 3-4)
- **Dirt cup lid not positioned properly or missing**
- Ensure that dirt cup lid is properly positioned
- **Filter assembly not installed properly**
- Ensure that pre-filter assembly and main filter are positioned properly (Figs. 3-9 to 3-10)

Problem: Cleaner hard to push

Possible cause

Possible solution

- **Incorrect carpet height setting**
- Move nozzle control knob to a higher setting

Problem: Cleaning tools won't pick up

Possible cause

Possible solution

- **Dirt cup not properly installed**

- Position dirt cup properly and snap in place (Fig. 3-4)

- **Blockage in hose**

- Clear blockage

Problem: Visible dirt leaking through final filter

Possible cause

Possible solution

- **Filter assembly not installed properly**
- Ensure that pre-filter assembly and main filter are positioned properly

Clearing blockages

Disconnect cleaner from electrical outlet.

Low suction or pick up may be due to a blockage in the system. Refer to the following steps to check for blockages **continuing with each step until the blockage is found:**

Turn cleaner OFF and disconnect from electrical outlet.

1. Check fullness of dirt cup and filter assembly; empty cup and clean filters if needed.

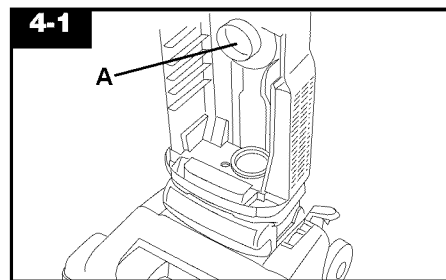

Check dirt duct

2. Remove dirt cup, look in duct (A).
3. Clear blockage from dirt duct.

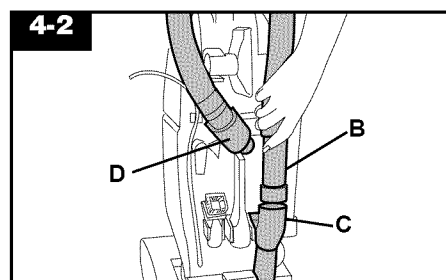

Check airflow path

4. Plug cleaner in and turn ON. Check for suction at end of hose (B).

- a. If there is **suction**, continue with step 5.
- b. If there is **no suction**, check for blockage in hose and dirt tube as follows:

- 1) Disconnect hose from dirt duct (D) by reversing procedure for "Attach hose" (Fig. 1-8 and 1-9).
- 2) Clear out hose.

- 3) Look into (D) and remove blockage.
5. Check connection at hose tube (C); remove any blockage.

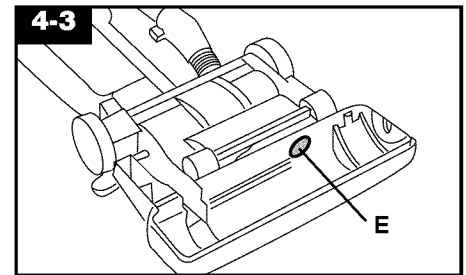

Checking under bottom plate

6. Turn cleaner OFF and unplug.
7. Remove bottom plate, belt and agitator (see "The belt" section).

Look into opening (E) for blockages and remove.

8. Remove agitator shield (see Fig. 3-21) and remove any loose debris which may have accumulated under it.

Full One Year Warranty (Domestic Use)

Your HOOVER® appliance is warranted in normal household use, in accordance with the Owner's Manual against original defects in material and workmanship for a period of one full year from date of purchase. This warranty provides, at no cost to you, all labor and parts to place this appliance in correct operating condition during the warranted period.

This warranty applies when the appliance is purchased in the United States including its territories and possessions, or in Canada or from a U.S. Military Exchange. Appliances purchased elsewhere are covered by a limited one year warranty which covers the cost of parts only. This warranty does not apply if the appliance is used in a commercial or rental application.

Warranty service can only be obtained by presenting the appliance to one of the following Authorized Warranty Service outlets. Proof of purchase will be required before service is rendered.

1. Hoover Factory Service Centers
2. Hoover Authorized Warranty Service Dealers (Depots)

For an automated referral of authorized service outlets in the U.S.A., phone 1-800-944-9200 OR visit The Hoover Company on-line at www.hoover.com

This warranty does not cover pick up, delivery, or house calls; however, if you mail your appliance to a Hoover Factory Service Center for warranty service, transportation will be paid one way.

While this warranty gives you specific legal rights, you may also have other rights which vary from state to state (or province).

If further assistance is needed, or if there are questions concerning this warranty or the availability of warranty service outlets, write or phone the Consumer Response Center, The Hoover Company, 101 East Maple St., North Canton, Ohio 44720.
Phone 330-499-9499.

In Canada, contact Hoover Canada, Burlington, Ontario, L7R 4A8.
Phone 1-800-263-6376.

HOOVER y  son marcas registradas

HOOVER et  sont des marques déposées

HOOVER and  are registered trademarks