

Use & Care Guide

30" Gas Range



 **Electrolux**

318 203 964 (1001) Rev. A

Finding Information 3

TABLE OF CONTENTS

Finding Information	2-3	Care & Cleaning	24-31
Make a Record for Future use.....	2	Using the Self-Clean Feature	24
Questions?	2	Starting the Oven Self-Clean Cycle.....	25
Safety	4-8	General Cleaning.....	26
Important Safety Instructions.....	4	Care and Cleaning of Stainless Steel.....	27
Getting Start	9	Cleaning the Burner Grates, Burner Caps and Burner Heads.....	27
Liquefied Petroleum (Propane) Gas Conversion.....	9	Cooktop Cleaning and Maintenance	29
Grounding instructions.....	9	Cleaning recommendations for the Ceramic Glass Cooktop.....	29-30
Range Features	10	Special Door Care Instructions.....	30
30" Range Features.....	10	To Remove and Replace the Oven Door.....	31
Surface Cooking	11-16	Oven Light	31
Flame size.....	11	Solutions to Common Problems	32-35
Proper Burner Adjustments	11	Surface Burners Do Not Light.....	32
Burner Locations	11	Burner Flame only Lights Half Way Around Burner	32
Placement of Burner Heads and Caps	12	Burner Flame is Orange	32
Placement of Burner Grates	12	Scratches or Abrasions on Ceramic Glass Cooktop Surface.....	32
Surface Cooking Utensils	13	Metal Marks on Ceramic Glass Cooktop Surface.....	33
Using the Griddle.....	13	Brow Streaks and Specks on Ceramic Glass Cooktop Surface.....	33
Using the Wok Stand.....	14	Areas of Discoloration on Ceramic Glass Cooktop Surface.....	33
Using the Simmer Plate.....	15	Appliance not Level	33
Setting Surface Controls.....	16	Poor Baking Results.....	33
Getting Started	17-18	Entire Oven Does Not Operate.....	34
Before Setting Oven Controls.....	17-18	Oven Light Does Not Work.....	34
Setting the Oven Controls	19-23	Fan Noise During Cooking Operation.....	34
Oven Control Features	19	Oven Smokes Excessively During Broiling.....	34
Getting Started	19	Self-Cleaning Cycle Does Not Work.....	35
Baking.....	19	Soil Not Completely Removed After Self-Cleaning Cycle is Completed.....	35
Baking Problems	20	Flames Inside Oven or Smoke From Vent.....	35
Convection Baking.....	21	Warranty Information	36
Convection Roasting	21		
Broiling.....	22		
Setting Broil	23		

4 Safety

IMPORTANT SAFETY INSTRUCTIONS



This manual contains important safety symbols and instructions. Please pay attention to these symbols and follow all instructions given.

WARNING

This symbol will help alert you to situations that may cause serious bodily harm, death or property damage.

CAUTION

This symbol will help alert you to situations that may cause bodily injury or property damage.

WARNING

To reduce the risk of fire, electrical shock, or injury when using your range, follow basic precaution including the following:

WARNING

If the information in this manual is not followed exactly, a fire or explosion may result causing property damage, personal injury or death.

FOR YOUR SAFETY:

- Do not store or use gasoline or other flammable vapors and liquids in the vicinity of this or any other appliance.
 - **WHAT TO DO IF YOU SMELL GAS:**
 - Do not try to light any appliance.
 - Do not touch any electrical switch; do not use any phone in your building.
 - Immediately call your gas supplier from a neighbor's phone. Follow the gas supplier's instructions.
 - If you cannot reach your gas supplier, call the fire department.
 - Installation and service must be performed by a qualified installer, servicer or the gas supplier.
-
- **Remove all tape and packaging wrap before using the appliance. Destroy the carton and plastic bags after unpacking the appliance.** Never allow children to play with packaging material.
 - **Proper Installation-Be sure your appliance is properly installed and grounded by a qualified technician in accordance with the National Fuel Gas Code ANSI Z223.1/NFPA 54 in the United States, or in Canada CAN/CGA B149.1, and CAN/CGA B149.2, and the National Electrical Code ANSI/NFPA No. 70—latest edition in United States, or in Canada CSA Standard C22.1, Canadian Electrical Code, Part 1, and local code requirements.** Install and/or adjust only per installation instructions provided in the literature package for this range.
 - **In case of an emergency, know how to disconnect the electrical power to the appliance at the circuit breaker or fuse box and how to turn off the gas supply at the main shut off valve.**



- **User Servicing—Do not repair or replace any part of the appliance unless specifically recommended in the manuals.** All other servicing should be done only by a qualified technician to reduce the risk of personal injury and damage to the range.
- **Never modify or alter the construction of a range by removing leveling legs, panels, wire covers, anti-tip brackets/screws, or any other part of the product.**

⚠️ WARNING

- All ranges can tip.
- Injury to persons could result.
- Install anti-tip device packed with range.
- See Installation Instructions.

To reduce the risk of tipping, the range must be secured by properly installed anti-tip bracket(s) provided with the range. To check if the bracket(s) is installed properly, remove the lower panel or storage drawer and verify that the anti-tip bracket(s) is engaged. Refer to the Installation Instructions for proper anti-tip bracket(s) installation.



⚠️ WARNING

- **Stepping, leaning or sitting on the door of this range can result in serious injuries and may also cause damage to the range.** Do not allow children to climb or play around the range. The weight of a child on an open door may cause the range to tip, resulting in serious burns or other injury. An open door, when hot, may cause burns.
- **Do not use the oven for storage.**
- **NEVER use this appliance as a space heater to heat or warm the room.** Doing so may result in carbon monoxide poisoning and overheating of the oven.

⚠️ CAUTION

Do not store items of interest to children in the cabinets above the appliance. Children climbing on the cooktop to reach items could be seriously injured.

- **Storage in or on Appliance—Flammable materials should not be stored in an oven, near surface burners or in the drawer (if equipped).** This includes paper, plastic and cloth items, such as cookbooks, plasticware and towels, as well as flammable liquids. Do not store explosives, such as aerosol cans, on or near the appliance. Flammable materials may explode and result in fire or property damage.
 - **Do not leave children alone—Children should not be left alone or unattended in the area where appliance is in use.** They should never be allowed to sit or stand on any part of the appliance.
 - **DO NOT TOUCH SURFACE BURNERS, AREAS NEAR THESE BURNERS, OVEN HEATING ELEMENTS OR INTERIOR SURFACES OF THE OVEN.** Both surface burners and oven heating elements may be hot even though they are dark in color. Areas near surface burners may become hot enough to cause burns. During and after use, do not touch, or let clothing or other flammable materials touch these areas until they have had sufficient time to cool. Among these areas are the cooktop, surfaces facing the cooktop, the oven vent openings and surfaces near these openings, oven door and window.
 - **Wear proper apparel—Loose-fitting or hanging garments should never be worn while using the appliance.** Do not let clothing or other flammable materials contact hot surfaces.
 - **Do not use water or flour on grease fires—Smother the fire with a pan lid, or use baking soda, a dry chemical or foam-type extinguisher.**
-

6 Safety

- **When heating fat or grease, watch it closely.** Fat or grease may catch fire if allowed to become too hot.
- **Use only dry potholders—Moist or damp potholders on hot surfaces may result in burns from steam.** Do not let potholders touch hot heating elements. Do not use a towel or other bulky cloth instead of a potholder.
- **Do not heat unopened food containers—Buildup of pressure may cause container to burst and result in injury.**

WARNING

In case of fire or gas leak, be sure to turn off the main gas shutoff valve.

- **Remove the oven door from any unused range if it is to be stored or discarded.**

IMPORTANT—Do not attempt to operate the oven during a power failure. If the power fails, always turn the oven off. If the oven is not turned off and the power resumes, the oven may begin to operate again. Food left unattended could catch fire or spoil.

IMPORTANT INSTRUCTIONS FOR USING YOUR COOKTOP

- **Know which knob controls each surface heating unit.** Always turn the knob to the LITE position when igniting the burners. Visually check that burner has lit. Then adjust the flame so it does not extend beyond the edge of the utensil.

WARNING

Use proper flame size—Adjust flame size so it does not extend beyond the edge of the utensil. The use of undersized utensils will expose a portion of the burner flame to direct contact and may result in ignition of clothing. Proper relation of utensil to flame will also improve cooking efficiency.

WARNING

Do not use stove top grills on the burner grates of sealed gas burners. If you use a stove top grill on a sealed gas burner, it will cause incomplete combustion and can result in exposure to carbon monoxide levels above allowable current standards. This can be hazardous to your health.

CAUTION

Electronic controllers can be damaged by cold temperatures. When you use your appliance for the first time, or if it has not been used for a long period of time, make sure that it has been exposed to a temperature above 0°C/32°F for at least 3 hours before connecting it to the power supply.

- **Use proper pan size.** This appliance is equipped with one or more surface burners of different sizes. Select utensils having flat bottoms large enough to cover the surface burner. The use of undersized utensils will expose a portion of the surface burner to direct contact and may result in ignition of clothing. Proper relationship of utensil to the surface burner will also improve efficiency.
 - **Utensil handles should be turned inward and not extend over adjacent surface burners—**To reduce the risk of burns, ignition of flammable materials, and spillage due to unintentional contact with the utensil. The handle of the utensil should be positioned so that it is turned inward, and does not extend over adjacent surface burners.
 - **Never leave surface burners unattended at high heat settings—**Boilovers cause smoking and greasy spillovers that may ignite, or a pan that has boiled dry may melt.
 - **Glazed cooking utensils—**Only certain types of glass, glass/ceramic, ceramic, earthenware, or other glazed utensils are suitable for rangetop service without breaking due to the sudden change in temperature. Check the manufacturer's recommendations for rangetop use.
-

- **Air curtain or other overhead range hoods, which operate by blowing a downward air flow on to a range, shall not be used in conjunction with gas ranges other than when the hood and range have been designed, tested and listed by an independent test laboratory for use in combination with each other.**
- **Do not use decorative surface burner covers.** If a burner is accidentally turned on, the decorative cover will become hot and possibly melt. Burns will occur if the hot covers are touched. Damage may also be done to the cooktop or burners because the covers may cause overheating. Air will be blocked from the burner and cause combustion problems.
- **Do not clean or operate a broken cooktop**—If cooktop should break, cleaning solutions and spillovers may penetrate the broken cooktop and create a risk of electric shock. Contact a qualified technician immediately.
- **Clean cooktop glass with caution**—If a wet sponge or cloth is used to wipe spills on a hot cooking area, be careful to avoid a steam burn. Some cleaners can produce harmful fumes if applied to a hot surface.
- **Avoid scratching the cooktop glass with sharp objects.**

IMPORTANT INSTRUCTIONS FOR USING YOUR OVEN

- **Use care when opening oven door or warmer drawer (if equipped)**—Stand to the side of the range when opening the door of a hot oven. Let hot air or steam escape before you remove or replace food in the oven/ warmer drawer.
- **Keep oven vent ducts unobstructed.** The oven vent is located under the cooktop. Touching the surfaces in this area when the oven is operating may cause severe burns. Also, do not place plastic or heat-sensitive items on or near the oven vent. These items could melt or ignite.

WARNING

Never cover any slots, holes or passages in the oven bottom or cover an entire rack with materials such as aluminum foil. Doing so blocks air flow through the oven and may cause carbon monoxide poisoning. Aluminum foil linings may also trap heat, causing a fire hazard.

- **Placement of oven/warmer drawer (if equipped) racks.** Always place oven racks in desired location while oven/warmer drawer (if equipped) is cool. If rack must be moved while oven is hot use extreme caution. Use potholders and grasp the rack with both hands to reposition. Do not let potholders contact the hot heating elements in the oven/warmer drawer (if equipped). Remove all utensils from the rack before moving.
- **Do not use the broiler pan without its insert.** The broiler pan and its insert allow dripping fat to drain and be kept away from the high heat of the broiler.
- **Do not cover the broiler insert with aluminum foil.** Exposed fat and grease could ignite.
- **Do not touch a hot light bulb with a damp cloth.** Doing so could cause the bulb to break. Disconnect the appliance or turn off the power to the appliance before removing and replacing light bulb.

IMPORTANT INSTRUCTIONS FOR CLEANING YOUR RANGE

- **Clean the range regularly to keep all parts free of grease that could catch fire.** Exhaust fan ventilation hoods and grease filters should be kept clean. Do not allow grease to accumulate on hood or filter. Greasy deposits in the fan could catch fire. When you are flaming food under the hood, turn the fan on. Refer to the hood manufacturer's instructions for cleaning.
-

8 Safety

SELF CLEANING OVENS

- **In the self-Cleaning cycle only clean the parts listed in this Use and Care Guide.**
Before self cleaning the oven, remove the broiler pan and any utensils or foods from the oven.
- **Do not use oven cleaners**—No commercial oven cleaner or oven liner protective coating of any kind should be used in or around any part of the oven.
- **Do not clean door gasket**—The door gasket is essential for a good seal. Care should be taken not to rub, damage or move the gasket.
- **Remove oven racks.** Oven racks color will change if left in the oven during a self-cleaning cycle.

CAUTION

The health of some birds is extremely sensitive to the fumes given off during the self-cleaning cycle of the range. Move the birds to another well ventilated room.

IMPORTANT SAFETY NOTICE

The California Safe Drinking Water and Toxic Enforcement Act requires the Governor of California to publish a list of substances known to the state to cause cancer, birth defects or other reproductive harm, and requires businesses to warn customers of potential exposure to such substances.

NOTE

Save these important safety instructions for future reference.

LIQUEFIED PETROLEUM (PROPANE) GAS CONVERSION

This appliance can be used with Natural Gas and Propane Gas. It is shipped from the factory for use with natural gas.

A kit for converting to LP gas is supplied with your cooktop. The kit is marked "FOR LP/PROPANE GAS CONVERSION". Follow the installation instructions which are inside the envelope.

The conversion must be performed by a qualified service technician in accordance with the kit instructions and all local codes and requirements. Failure to follow instructions could result in serious injury or property damage. The qualified agency performing this work assumes responsibility for the conversion.

⚠ WARNING

Severe shock, or damage to the cooktop may occur if the cooktop is not installed by a qualified installer or electrician.

⚠ CAUTION

Any additions, changes or conversions required in order for this appliance to satisfactorily meet the application needs must be made by a qualified service technician in accordance with the manufacturer's instructions and all codes and requirements of the authority having jurisdiction. Failure to follow the instructions could result in serious injury or property damage. The qualified agency performing this work assumes responsibility for the conversion.

GROUNDING INSTRUCTIONS

For personal safety, the cooktop must be properly grounded. For maximum safety, the power cord must be plugged into an electrical outlet that is correctly polarized and properly grounded.

DO NOT Operate the cooktop using a 2-prong adapter or an extension cord. If a 2-prong wall receptacle is the only available outlet, it is the personal responsibility of the consumer to have it replaced with a properly grounded 3-prong wall receptacle installed by a qualified electrician.

See the **INSTALLATION INSTRUCTIONS** packaged with this range for complete installation and grounding instructions.

⚠ WARNING

- This appliance is equipped with a 3-prong grounding plug for your protection against shock hazard and should be plugged directly into a properly grounded receptacle. **DO NOT** cut or remove the grounding prong from this plug.

- Personal injury or death from electrical shock may occur if the range is not installed by a qualified installer or electrician.

- Avoid fire hazard or electrical shock. **DO NOT** use an adapter plug, an extension cord, or remove grounding prong from electrical power cord. Failure to follow this warning can cause serious injury, fire or death.

Grounding type wall receptacle

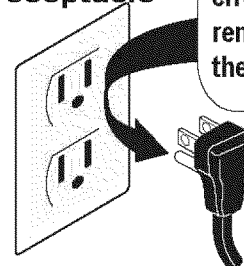

Do not, under any circumstances, cut, remove, or bypass the grounding prong.

Power supply cord with 3-prong grounding plug

10 Range Features

30" RANGE FEATURES

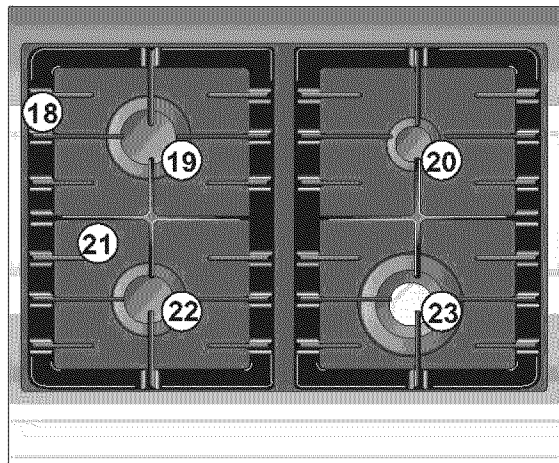
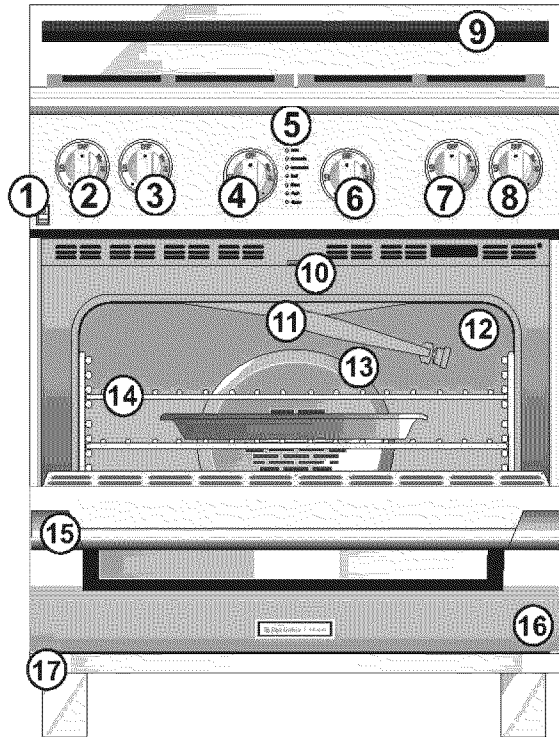

1. Oven Light Switch
2. Left Rear Burner Control Knob
3. Left Front Burner Control Knob
4. Oven Function Control Knob
5. Oven Function Indicator Lights
6. Oven Temperature Control Knob
7. Right Front Burner Control Knob
8. Right Rear Burner Control Knob
9. Oven Vent
10. Oven Door Latch
11. Broil Burner
12. Self-Clean Oven
13. Convection Fan Cover
14. Adjustable Oven Racks
15. Door Handle
16. Stainless Steel Oven Door With Large Window Opening
17. Stainless Steel Trim
18. Burner Grates
19. 14000 BTU Burner
20. 5000 BTU Simmer Burner
21. Glass Cooktop
22. 9500 BTU Burner
23. 18000 BTU Dual Flame Burner
24. Broiler Pan Cover
25. Broiler Pan
26. Top Burner Griddle
27. Wok Stand
28. Simmer Plate

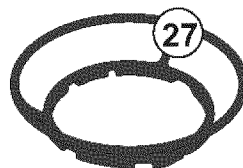
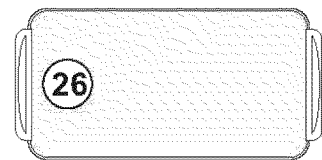
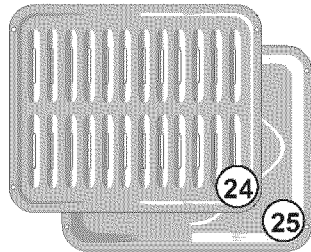

Surface Cooking 11

FLAME SIZE



For most cooking, start on the highest control setting and then turn to a lower one to complete the process. Use the chart below as a guide for determining proper flame size for various types of cooking. The size and type of utensil used and the amount of food being cooked will influence the setting needed for cooking.

For deep fat frying, use a thermometer and adjust the surface control knob accordingly. If the fat is too cool, the food will absorb the fat and be greasy. If the fat is too hot, the food will brown so quickly that the center will be undercooked. Do not attempt to deep fat fry too much food at once as the food will neither brown nor cook properly.

*Flame Size	Type of Cooking
High Flame	Start most foods; bring water to a boil; pan broiling
Medium Flame	Maintain a slow boil; thicken sauces, gravies; steam
Low Flame	Keep foods cooking; poach; stew

***These settings are based on using medium-weight aluminum pans with lids. Settings may vary when using other types of pans.**

Never extend the flame beyond the outer edge of the utensil. A higher flame simply wastes heat and energy, and increases your risk of being burned by the flame.

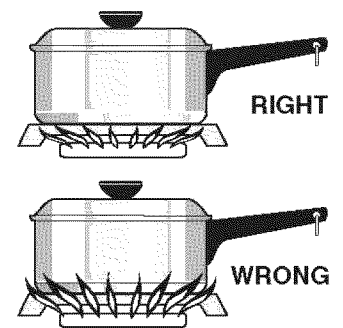

PROPER BURNER ADJUSTMENTS



The color of the flame is the key to proper burner adjustment. A good flame is clear, blue and hardly visible in a well-lighted room. Each cone of flame should be steady and sharply defined. Adjust or clean burner if flame is yellow-orange. To clean burner, see instructions under **General Care & Cleaning**.

BURNER LOCATIONS

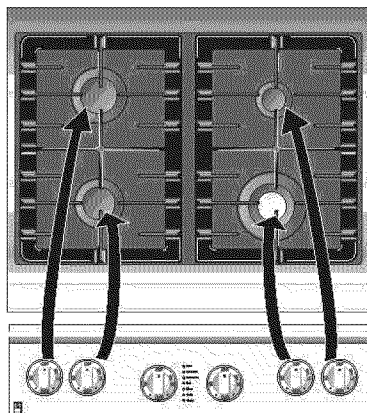

Your cooktop is equipped with different sized burners. The surface burners are located on the 30" models as follows (Fig. 1): a **5 000 BTU** (natural gas) burner at the right rear position; a **14 000 BTU** (natural gas) burner at the left rear position; and one **18 000 BTU Dual Flame** (natural gas) burner at the right and one **9 500 BTU** (natural gas) burner at the left front position.

12 Surface Cooking

PLACEMENT OF BURNER HEADS AND CAPS

For the 18 000 BTU burner:

Place the burner head over the gas orifice (Figure 1). **Be careful not to damage the electrode while placing the burner head over the orifice.** Make sure electrode fits correctly into slot in burner head.

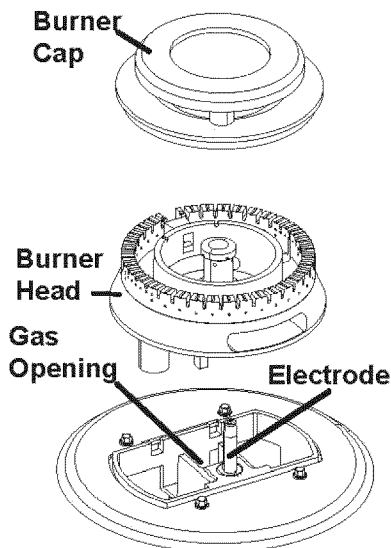

Figure 1

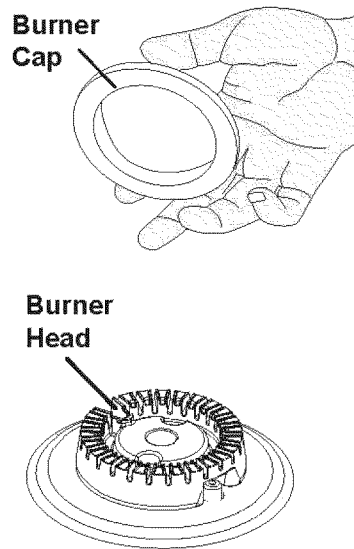

Figure 2

For all burners:

Place a burner cap on each burner head (see Figure 2), matching the cap size to the head size. The cap for each burner has an inner locating ring which centers the cap correctly on the burner head. Be sure that all the burner caps and burner heads are correctly placed BEFORE using your appliance.

Make sure each burner cap is properly aligned and level.

Turn the burner on to determine if it will light. If the burner does not light, contact a Service Center. Do not service the sealed burner yourself.

PLACEMENT OF BURNER GRATES

Place grates on the Ceramic Glass Cooktop. Be sure they are right located inside the stainless steel frame.

ATTENTION: Do not slide the grates on the stainless steel frame, doing so can damage the surface.

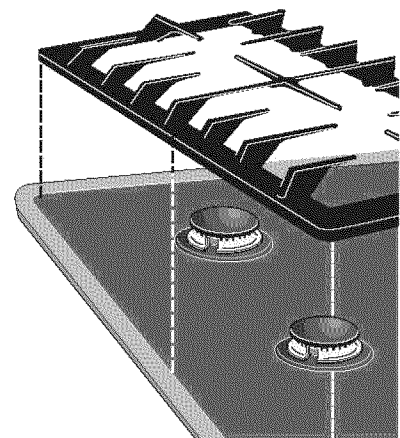
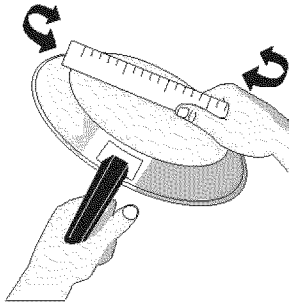

Figure 1

SURFACE COOKING UTENSILS



Pans should have flat bottoms. Check for flatness by rotating a ruler across the bottom. There should be no gaps between the pan and ruler.

* Specialty pans such as lobster pots, griddles and pressure cookers may be used but must conform to the above recommended cookware requirements.

*GOOD

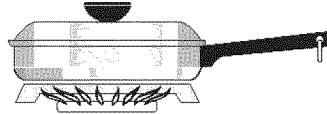

- **Flat bottom** and straight sides.
- Tight fitting lids.
- Weight of handle does not tilt pan. Pan is well balanced.
- Pan sizes match the amount of food to be prepared and the size of burner.
- Made of material that conducts heat well.
- Easy to clean.

POOR

- Curved and warped pan bottoms.

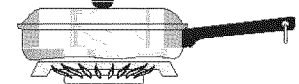

- Pan overhangs unit by more than 2.5 cm (1").

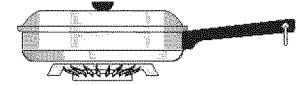

- Heavy handle tilts pan.

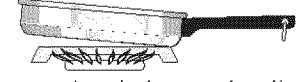

- Flame extends beyond unit.

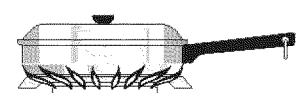

Note: Always use a utensil for its intended purpose. Follow manufacturer's instructions. Some utensils were not made to be used in the oven or on the cooktop.

USING THE GRIDDLE

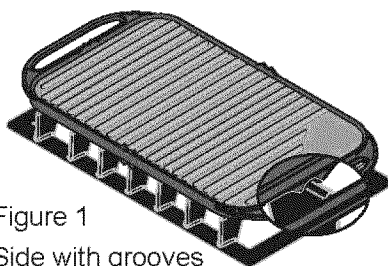

Figure 1
Side with grooves

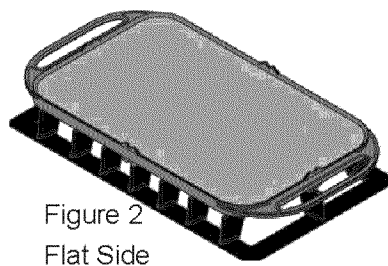

Figure 2
Flat Side

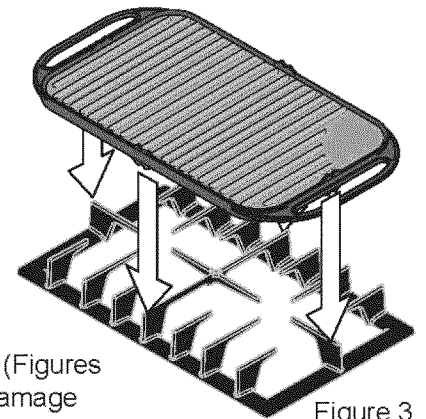

Figure 3

The griddle is intended for direct food cooking and can be used on both sides (Figures 1 and 2). Do not use pans or other cookware on the griddle. Doing so could damage the finish. With the grate in position over the burner, set the griddle on top of the grate positioning the notches in the griddle over the grate fingers (Figures 1 and 3).

⚠ CAUTION

Always place the griddle on the grate before to turn on the burner.

Always use potholders to remove the griddle from the grate. Allow the griddle to cool before removing. Do not set hot griddle on surfaces that cannot withstand high heat; such as countertops.

Be sure the griddle is positioned correctly and stable before use to prevent hot spills and possible burns.

14 Surface Cooking

USING THE WOK STAND



The Wok Stand provided with your cooktop is designed to allow round-bottomed woks to be used. **It is recommended that you use a 14 inch diameter (35.5 cm) or less Wok.** It is recommended that you use the right front **POWER** burner with the wok stand for best performance. If properly positioned, the Wok Stand will not slide off the grate.

⚠ CAUTION

Always use potholders to remove the wok stand from the grate. Allow the wok stand to cool before removing. Do not set hot wok stand on surfaces that cannot withstand high heat; such as countertops.

Be sure the Wok Stand is positioned correctly and stable before use to prevent hot spills and possible burns.

To Properly Position the Wok Stand:

With the grate in position over the burner, set the Wok Stand on top of the grate positioning the notches in the Wok Stand over the cooktop grate fingers (See Figure 1).

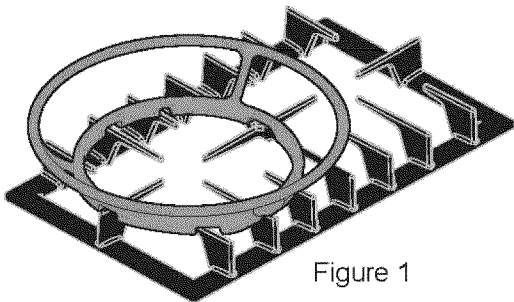

Figure 1

NOTE

The Wok cooking performance is best on the right front **POWER** burner position.

⚠ CAUTION

Be sure to **ALWAYS** use the Wok Stand if the stability of the wok is uncertain. If cooking large amounts of liquid food without the Wok Stand, the wok may tip and spill over causing burns.

Flat-bottom woks with large flat bottoms may also be used on your cooktop Surface Burner Grates without the Wok Stand (See Figure 2). Insure the stability of the flat-bottom wok before cooking without the Wok Stand. If unstable, **DO NOT** use the flat-bottom wok without the Wok Stand.

Round-bottom woks (with a support ring) should **NOT** be used (See Figure 3). The supporting ring was not designed for proper or stable use on the Surface Burner Grates.

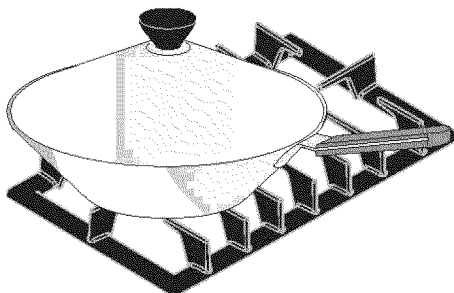

Proper use of flat-bottom wok
on Surface Burner Grate
Figure 2

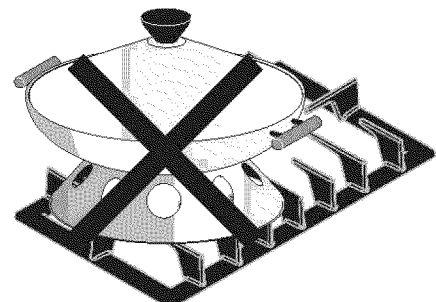

Improper use of round-bottom wok
on Surface Burner Grate
Figure 3

USING THE SIMMER PLATE



The simmer plate (Figure 1) is intended to diffuse lower temperature of the burner to help cooking delicate aliment such as chocolate, milk, bechamel, etc. It can also be use for cooking sauce during long period. With the grate in position over the burner, set the simmer plate on top of the grate positioning the notches in the simmer plate over the grate fingers (See Figure 2) and then place the utensil on the simmer plate.

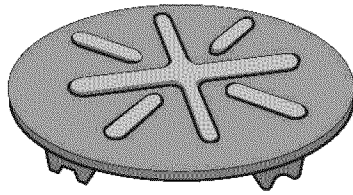

Figure 1

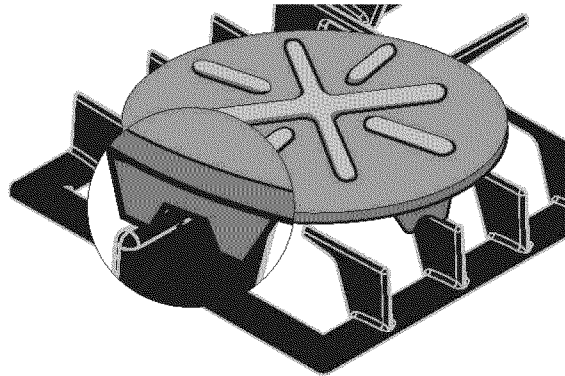

Figure 2

⚠ CAUTION

Always place the simmer plate on the grate before to turn on the burner.

Always use potholders to remove the simmer plate from the grate. Allow the simmer plate to cool before removing. Do not set hot simmer plate on surfaces that cannot withstand high heat; such as countertops.

Be sure the simmer plate is positioned correctly and stable before use to prevent hot spills and possible burns.

BEFORE SETTING OVEN CONTROLS



Oven Vent Location

The oven is vented **through the back-guard**. When the oven is on, warm air is released through the vent. This venting is necessary for proper air circulation in the oven and good baking results.

Oven vent

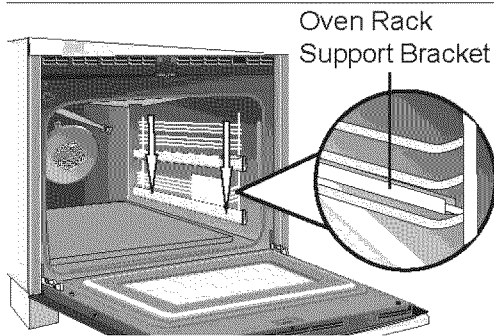
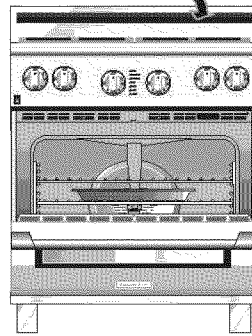

Oven Rack Support Bracket

Installing Oven Rack Supports

ALWAYS INSTALL OVEN RACK SUPPORT BEFORE TURNING ON THE OVEN (WHEN THE OVEN IS COOL).

To remove the oven rack supports for a self-clean cycle, pull up the support from the oven rack support brackets to disengage supports from the oven. If the rack supports are not removed, the self-clean cycle won't start. Always remove the left side support first. **To install oven rack supports** insert the rack supports into the rack support brackets on the oven side as shown.

Removing and Replacing Oven Racks

Racks *ALWAYS ARRANGE OVEN RACKS WHEN THE OVEN IS COOL (PRIOR TO OPERATING THE OVEN).* Always use oven mitts when using the oven.

To remove an oven rack, pull the rack forward. Lift up the rack off the oven rack slider. **To replace an oven rack**, place the rack on the slider into the 4 pinholes located at the 4 corners of the rack.

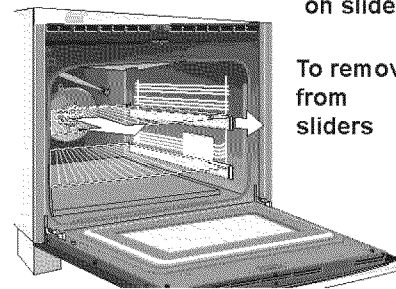

Installed on sliders



To remove from sliders



To place on sliders



Pull oven rack forward and lift it up of the oven rack slider.

Removing Non-Sliding Oven Racks

Simply pull the rack and slightly tilt it upward when the rack hits its stop position.

Replacing Non-Sliding Oven Racks

Insert the rack into the oven rack supports by inserting the rack openings into the rack supports. Be sure the rack is at the same position on each oven rack support on both sides.

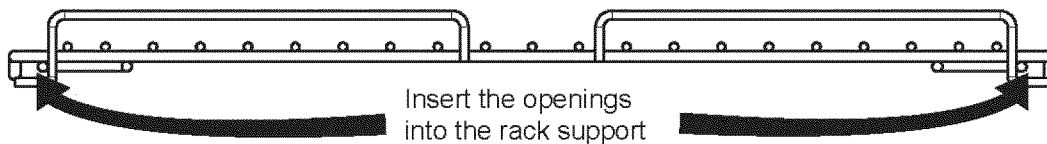

Insert the openings into the rack support

⚠ WARNING Always arrange the oven racks when the oven is cool (prior to operating the oven). Always use oven mitts when using the oven.

18 Getting Started

BEFORE SETTING OVEN CONTROLS (CONT'D)

Oven Rack Positions

ALWAYS ARRANGE OVEN RACKS WHEN THE OVEN IS COOL (PRIOR TO OPERATING THE OVEN) Always use oven mitts when the oven is hot.

⚠ CAUTION

Always use pot holders or oven mitts when adjusting the oven racks. Wait until the oven has completely cooled if possible. Oven racks may be HOT and may cause burns.

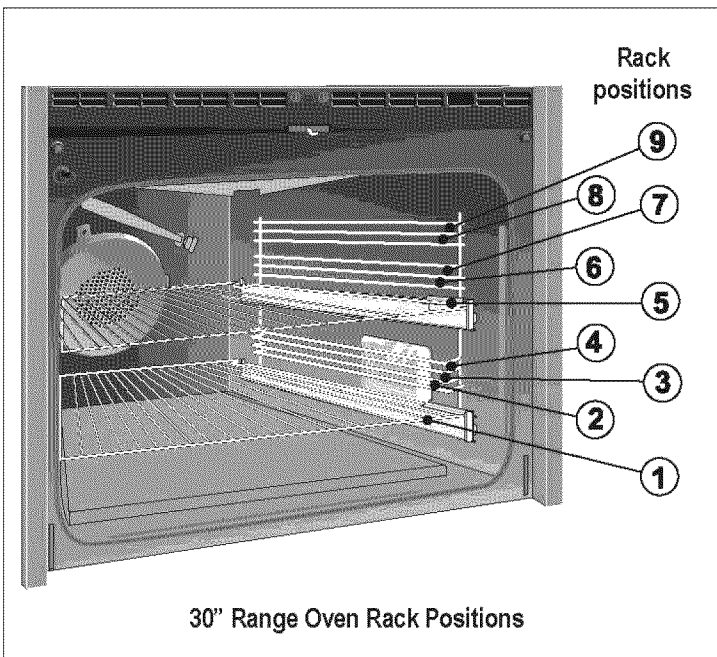

RECOMMENDED RACK POSITIONS

	Rack Positions
MODE: BAKE	
1 Rack, general use	5
1 Rack, specific use:	
Frozen pies,	2 or 3
Angel food cake,	2 or 3
Bread, Casseroles,	2 or 3
Small cuts of meat or poultry	2 or 3
Turkey, Roast or Ham	1
2 Racks :	
Cookies	5 & 9 or 2 & 5
Cakes	5 & 9 or 2 & 5
Croissants	5 & 9
MODE: CONVECTION BAKE	
1 Rack	5
2 Racks:	
Cookies	5 & 9
Cakes	2 & 5
Croissants	5 & 9
3 Racks	1, 5 & 9
Note: Always use caution when removing food.	

Air Circulation in the Oven

For best air circulation and baking results allow 2-4» (5-10 cm) around the cookware for proper air circulation and be sure pans and cookware do not touch each other, the oven door, sides or back of the oven cavity. The hot air must circulate around the pans and cookware in the oven for even heat to reach around the food.

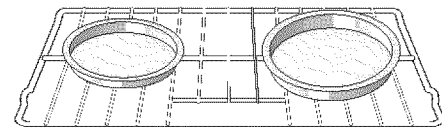

1 Oven Rack

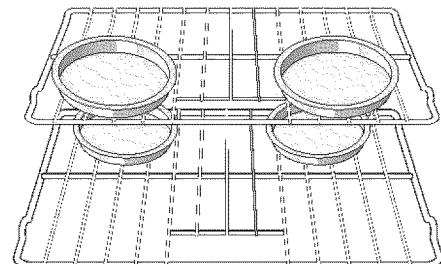

Multiple Oven Racks

Setting the oven controls 19

CONTROL FEATURES

READ THE INSTRUCTIONS CAREFULLY BEFORE USING THE OVEN. For satisfactory use of your oven, become familiar with the various features and functions of the oven as described below. **Detailed instructions for each feature and function follow later in this Use & Care Guide.**

SELECTOR CONTROL KNOB- Use to select the Bake, Convection Bake, Convection Roast, Broil or Clean Feature.

CLEAN— Used to select the Self-Cleaning cycle.

BROIL— Used to select the broil function.

CONVECTION ROAST— Used to select the convection roasting mode.

BAKE— Used to select the bake function.

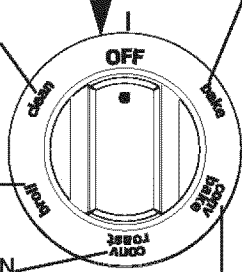

CONVECTION BAKE— Used to select the Convection Bake feature.

OVEN TEMPERATURE CONTROL KNOB— Use to select the required Bake, Convection Bake, Convection Roast, Broil or Clean Temperature.

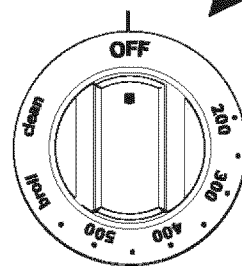

- Bake
- Conv Bake
- Conv Roast
- Broil
- Clean
- -Lock
- -Racks

OVEN FUNCTION INDICATOR LIGHTS— Used to indicate which function is used.

GETTING STARTED

When the unit is first plugged in, or when the power supply to the range has been interrupted, the indicator lights will flash and the control will beep. To stop the lights from flashing, turn the selector control knob to **BAKE** and back to **OFF**.

BAKING

The oven can be set to bake at any temperature from 170°F to 550°F

To set the Bake Temperature to 350°F:

1. Arrange interior oven racks, place food in oven and close oven door.
2. Turn the selector control knob to **Bake**.
3. The corresponding indicator light will flash.
4. Turn the temperature control knob to **350**. The indicator light will stop flashing and the oven will begin to preheat.

A beep will sound once when temperature reaches 350°F.

The indicator light will stay on until the Selector or the Temperature knob is turned to the Off position.

5. When baking is completed, turn the temperature and the selector control knobs to **Off** position.

To change the Bake temperature (example changing from 350°F to 425°F):

1. After the oven has already been set at 350°F, and the oven temperature needs to be changed to 425°F, turn the temperature control knob to 425°F. A beep will sound when the oven temperature reaches 425°F.





20 Setting the oven controls

BAKING PROBLEMS

For best cooking results, pre-heat the oven before baking cookies, breads, cakes, pies or pastries, etc.

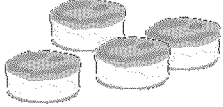
The cooking times and temperatures needed to bake a product may vary slightly from your previously owned appliance.

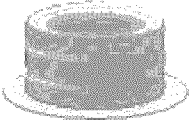
Baking Problems and Solutions Chart

Baking Problems	Causes	Corrections
Cookies and biscuits burn on the bottom. 	<ul style="list-style-type: none"> • Cookies and biscuits put into the oven before the preheating time is completed. • Oven rack overcrowded. • Dark pan absorbs heat too fast. 	<ul style="list-style-type: none"> • Allow oven to preheat to the selected temperature before placing food in oven. • Choose pan sizes that will permit 2" to 4" (5.1cm to 10.2cm) of air space on all sides when placed in the oven. • Use a medium-weight aluminum baking sheet.
Cakes too dark on top or bottom. 	<ul style="list-style-type: none"> • Cakes put into the oven before preheating time is completed. • Rack position too high or low. • Oven too hot. 	<ul style="list-style-type: none"> • Allow oven to preheat to the selected temperature before placing food in the oven. • Use proper rack position for baking needs. • Set oven temperature 25°F lower than recommended.
Cakes not done in the center 	<ul style="list-style-type: none"> • Oven too hot. • Incorrect pan size. • Pan not centered in oven. 	<ul style="list-style-type: none"> • Set oven temperature 25°F lower than recommended. • Use pan size suggested in recipe. • Use proper rack position and place pan so there is 2" to 4" (5.1 cm to 10.2 cm) of space on all sides of pan.
Cakes not level. 	<ul style="list-style-type: none"> • Range not level. • Pan too close to oven wall or rack overcrowded. • Pan warped. 	<ul style="list-style-type: none"> • Place a marked glass measuring cup filled with water on the center of the oven rack. If the water level is uneven, refer to the installation instructions for leveling the appliance. • Be sure to allow 2" to 4" (5.1 cm to 10.2 cm) of clearance on all sides of each pan in the oven. • Do not use pans that are dented or warped.
Foods not done when cooking time is up. 	<ul style="list-style-type: none"> • Oven too cool. • Oven overcrowded. • Oven door opened too frequently. 	<ul style="list-style-type: none"> • Set oven temperature 25°F higher than suggested and bake for the recommended time. • Be sure to remove all pans from the oven except the ones to be used for baking. • Open oven door only after shortest recommended baking time.

CONVECTION BAKING

Use the Convection Bake feature when cooking on multiple racks is desired. The oven can be programmed for Convection baking at any temperature between 300°F and 550°F. Convection baking uses a fan to circulate the oven's heat evenly and continuously within the oven (See Figure 1). This improved heat distribution allows even cooking and browning results at a lower temperature than conventional bake. It also gives better baking results when using 2 or 3 racks at the same time. Breads and pastries brown more evenly. Convection bake cooks most foods faster and more evenly than conventional bake. For baking efficiency, the fan rotates slower in Convection Bake than in Convection Roast.

Note: Allow up to 6 minutes for the convection fan to start rotating.

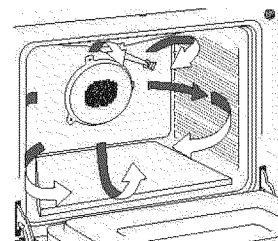

Figure 1
Air circulation during
Convection Bake

General Convection Bake Instructions

1. Adjust the cook time for desired doneness as needed. Time reductions will vary depending on the amount and type of food to be cooked.
2. Cookies and biscuits should be baked on pans with no sides or very low sides to allow heated air to circulate around the food. Food baked on pans with a dark finish will cook faster.
3. Make sure you set a temperature of 300°F minimum when using convection bake, or the function will not start.

To set the oven to Convection Bake at 350°F

1. Arrange interior oven racks, place food in oven and close oven door.
2. Turn the selector control knob to **Conv Bake**. The corresponding indicator light will flash.
3. Turn the temperature control knob to **350**. The indicator light will stop flashing and the oven will begin to heat. A beep will sound once the oven reaches 350°F. The indicator light will remain on until the Selector or Temperature control knob is turned to the Off position.
4. When baking is completed, turn the temperature and selector control knobs to **Off** position.

Benefits of Convection Bake:

- Multiple rack baking.
- No special pans or bakeware needed.

CONVECTION ROASTING

This method of cooking enables you to obtain the best results when roasting. All baking modes can be used to successfully roast in your oven. However, the Convection Roast mode is recommended to produce meats that are deliciously seared on the outside and succulently juicy on the inside in less time. The oven can be programmed to convection roast at any temperature from 300°F to 550°F. Remember to use tested recipes with times adjusted for convection roasting when using the convection mode. Times may be reduced by as much as 30% when using the convection feature. For roasting efficiency, the fan rotates faster in Convection Roast than in Convection Bake. When preparing meats for convection roasting, use the broiler pan and insert along with a roasting rack. The roasting rack will allow heat to circulate around the meat.

Note: Allow up to 6 minutes for the convection fan to start rotating.

To Set the oven to Convection Roast at 350°F

1. Arrange interior oven racks, place food in oven and close oven door.
2. Turn the selector control knob to **Conv Roast**. The corresponding indicator light will flash.
3. Turn the temperature control knob to **350**. The indicator light will stop flashing and the oven will begin to heat. The indicator light will remain on until the Selector or Temperature control knob is turned to the Off position.
4. When baking is completed, turn the temperature and the selector control knobs to **Off**.

Note: Make sure you set a temperature of 300°F minimum when using convection bake, or the function will not start.

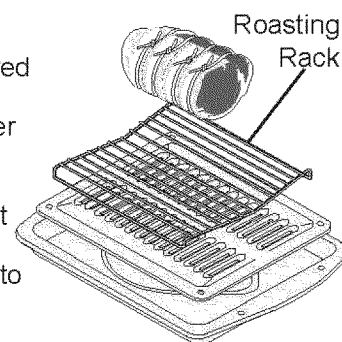

22 Setting the oven controls

BROILING



Broiling is a method of cooking tender cuts of meat by direct heat under the broil element of the oven.

Preheating

For an optimum browning, preheat the broil burner for 2 to 5 minutes.

To Broil

Broil one side until the food is browned; turn and cook on the second side. Season and serve. Always pull the rack out to the «stop» position before turning or removing food.

Broiling Tips

The broiler pan and its grid allow dripping grease to drain and be kept away from the high heat of the broiler.

Broiling Times

Use the following table for approximate broiling times. Increase or decrease broiling times, or move the broiling pan to a different rack position to suit for doneness. If the food you are broiling is not listed in the table, follow the instructions provided in your cookbook and watch the item closely.

Broiling Table Recommendations					
Food Item	Rack Position	Knob Setting	Cook Time		Doneness
			<i>1st side</i>	<i>2nd side</i>	
Steak 1" thick	7	Broil	6:00	4:00	Rare
	7	Broil	7:00	5:00	Medium
Pork Chops 3/4" thick	7	Broil	8:00	6:00	Well
Chicken - Bone In	5	Broil	20:00	10:00	Well
Chicken - Boneless	7	Broil	8:00	6:00	Well
Fish	7	Broil	13:00	0:00	Well
Shrimp	5	Broil	5:00	0:00	Well
Hamburger 1" thick	7	Broil	9:00	7:00	Medium
	5	Broil	10:00	8:00	Well

NOTE

DO NOT use the pan without its grid. DO NOT cover the grid with foil. The exposed grease could ignite.

CAUTION

Should an oven fire occur, close the oven door and turn off the oven. If the fire continues, throw baking soda on the fire or use fire extinguisher. DO NOT put water or flour on the fire. Flour may be explosive.

Setting the oven controls 23

SETTING BROIL



When broiling, heat radiates downward from the oven broiler for even coverage.

The broil pan and broil pan insert used together allow dripping grease to drain and be kept away from the high heat of the oven broiler. **DO NOT** use the broil pan without the insert. **DO NOT cover the broil pan insert with foil.** The exposed grease could ignite.

WARNING

Should an oven fire occur, leave the oven door closed and turn off the oven. If the fire continues, throw baking soda on the fire or use a fire extinguisher. **DO NOT** put water or flour on the fire. Flour may be explosive and water can cause a grease fire to spread and cause personal injury.

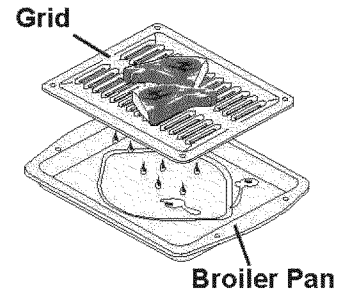

To set the oven to broil

1. Place broiler pan insert on the broiler pan. Then place the food on the broiler pan insert. **DO NOT** use the broiler pan without the insert. **DO NOT** cover the broiler insert with foil. The exposed grease could ignite.
2. Arrange the interior oven rack and place the broiler pan on the rack. Be sure to center the broiler pan directly under the broiler element. If preheating the broil element, position the broiler pan with food after step 5.
3. Turn Selector knob to Broil position.
4. The corresponding indicator light will flash.
5. Turn Temperature knob to Broil. The indicator light will remain on until the Selector or Temperature knob is turned to the Off position.

Note: When broiling, the appliance cooling fan will turn at high speed to keep the control panel cool.

Broiler Clean-Up Tips:

To make cleaning easier, line the bottom of the broiler pan with aluminum foil. **DO NOT** cover the broiler grid with foil.

To prevent grease from baking on, remove the broiler pan from the oven as soon as cooking is completed. Use hot pads because the broiler pan is extremely hot. Pour off grease. Soak the pan in **HOT**, soapy water.

Clean the broiler pan as soon as possible after each use. If necessary, use soap-filled steel wool pads. Heavy scouring may scratch the grid.

24 Care & Cleaning

USING THE SELF-CLEAN FEATURE

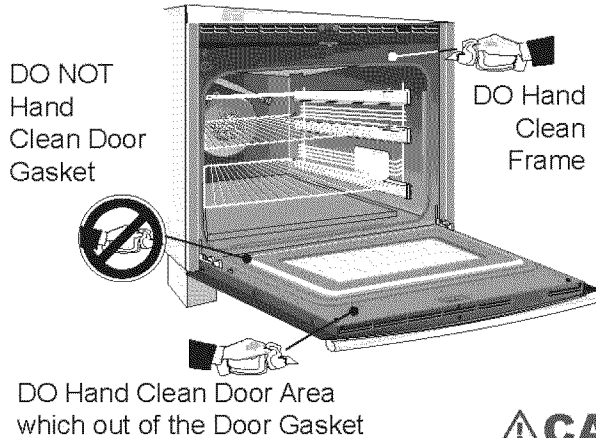

Adhere to the Following Cleaning Precautions:

- Allow the oven to cool before cleaning.
- Wear rubber gloves when cleaning any exterior parts of the oven manually.

During the self-cleaning cycle, the outside of the range can become very hot to the touch. DO NOT leave a small children unattended near the range.

Before cleaning any part of the oven, be sure the oven is turned off. Wait until the oven is cool.

CAUTION

The health of some birds is extremely sensitive to the fumes given off during the self-clean cycle of any wall oven. Move birds to another well ventilated room.

DO NOT use commercial oven cleaners or oven protective coatings in or around any part of the self-cleaning oven. **DO NOT** clean the oven door gasket. The gasket on the oven door is essential for a good seal. Care should be taken not to rub, damage or move the gasket. **DO NOT** use any cleaning materials on the gasket. Doing so could damage it. **DO NOT** use **aluminum foil** to line the oven bottom. This may affect cooking or foil could melt and damage the oven surface.

A self-cleaning oven cleans itself with high temperatures (well above cooking temperatures) which eliminate soil completely or reduce it to a fine powdered ash you can whisk away with damp cloth.

Preparing the Oven for Self-Cleaning

1. **Remove any excess spills** in the oven cavity before starting the self-cleaning cycle. To clean, use hot soapy water and a cloth. Large spills can cause smoke or a fire when subjected to high temperatures. **DO NOT** allow food spills with a high sugar or acid content (such as tomatoes, sauerkraut, fruit juices or pie filling) to remain on the surface as they may leave a dull spot even after cleaning.
2. Clean any soil from the oven frame and the door liner (see illustration). These areas heat sufficiently during a self-clean to burn soil on. Clean with hot soapy water.
3. Remove all utensils and any foil. These items cannot withstand high cleaning temperatures.
4. Oven racks and oven rack supports must be removed. If they are not removed the self-cleaning cycle cannot start and the "Racks" Indicator Light will begin to flash indicating that you must remove the racks and rack gliders with the supports before starting the clean cycle. When the cycle has finished and the door can be opened, replace the oven the oven rack supports and oven racks.

STARTING THE OVEN SELF-CLEAN CYCLE



If you are planning to use the oven directly after a self-clean cycle remember to allow time for the oven to cool down and the oven door to unlock. This normally takes about one hour. So to self-clean for 3 hours will actually take about 4 hours to complete.

WARNING

During the self-cleaning cycle, the outside of the range can become very hot to the touch. **DO NOT** leave small children unattended near the appliance; they may be burned if they touch the hot oven door surfaces.

CAUTION

DO NOT force the oven door open. This can damage the automatic door locking system. Use care when opening the oven door after the self-cleaning cycle. Stand to the side of the oven when opening the door to allow hot air or steam to escape. The oven may still be **VERY HOT**.

To start a Self-Cleaning cycle:

1. Be sure oven is empty and the oven door is closed.
2. Turn the selector knob to **Clean** position.
3. The corresponding indicator light will flash.
4. Turn the Temperature Control Knob to Clean position.
5. The Lock indicator light will flash while changing from unlock to lock. It will stop flashing when the door is locked.

NOTE

If the “Racks” indicator light is flashing when the clean mode is initiated, the oven racks and rack glides with supports have not been removed. It will continue flashing, once the selector knob is set back to the off position and the racks and rack glides with supports are removed from the oven.

6. As soon as the controls are set to clean, the motor driven oven door lock will begin to close automatically. Once the door has been locked the indicator light will stop flashing and remain on. Allow about 30 seconds for the oven door lock to close.

26 Care & Cleaning

GENERAL CLEANING

Cleaning Various Parts of Your appliance

Before cleaning any part of the appliance, be sure all controls are turned OFF and the appliance is COOL. REMOVE SPILLOVERS AND HEAVY SOILING AS SOON AS POSSIBLE. REGULAR CLEANINGS WILL REDUCE THE NUMBER OF MAJOR CLEANINGS LATER

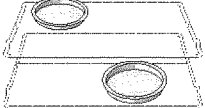
Surfaces	How to Clean
Aluminum (Trim Pieces) & Vinyl	Use hot, soapy water and a cloth. Dry with a clean cloth. Do not scour or use all-purpose cleaners, ammonia, powdered cleaners or commercial oven cleaner. They can scratch and discolor aluminum.
Painted and Plastic, Control Panel, Body Parts, and Decorative Trim	<p><i>For general cleaning</i>, use hot, soapy water and a cloth. <i>For more difficult soils and built-up grease</i>, apply a liquid detergent directly onto the soil. Leave on soil for 30 to 60 minutes. Rinse with a damp cloth and dry. DO NOT use abrasive cleaners on any of these materials; they can scratch.</p> <p>To remove control knobs, turn to the OFF position; grasp firmly and pull straight off the shaft. To replace knobs after cleaning, line up the flat sides of both the knob and the shaft; then push the knob into place.</p>
Stainless Steel, Chrome, Control Panel, Decorative Trim	<p><i>Before cleaning the control panel</i>, turn all controls to OFF and remove the control knobs. To remove, pull each knob straight off the shaft. Clean using hot, soapy water and a dishcloth. Rinse with clean water using a dishcloth. Be sure to squeeze excess water from the cloth before wiping the panel; especially when wiping around the controls. Excess water in or around the controls may cause damage to the appliance. To replace knobs after cleaning, line up the flat sides of both the knob and the shaft; then push the knob into place.</p> <p>Clean stainless steel with hot, soapy water and a dishcloth. Rinse with clean water and a cloth. Do not use cleaners with high concentrations of chlorides or chlorines. Always clean on the same direction as the stainless steel grain. Do not use harsh scrubbing cleaners. Only use kitchen cleaners that are especially made for cleaning stainless steel. Always be sure to rinse the cleaners from the surface as bluish stains may occur during heating that cannot be removed.</p>
Porcelain Enamel, Broiler Pan and Insert, Door Liner, Body Parts	Gentle scouring with a soapy scouring pad will remove most spots. Rinse with a 1:1 solution of clear water and ammonia. <i>If necessary</i> , cover difficult spots with an ammonia-soaked paper towel for 30 to 40 minutes. Rinse with clean water and a damp cloth, and then scrub with a soap-filled scouring pad. Rinse and wipe dry with a clean cloth. Remove all cleaners or the porcelain may become damaged during future heating. DO NOT use spray oven cleaners on the cooktop.
Oven Racks	<p>CAUTION Remove the ladder racks and oven racks during self-cleaning. These items will be permanently damaged by the high cleaning temperatures. If the racks are not removed, the self-clean cycle won't start and "Racks" indicator light will lite.</p> 
Oven Door	<p>Use soap & water to thoroughly clean the top, sides and front of the oven door. Rinse well. You may use a glass cleaner on the outside glass of the oven door. DO NOT immerse the door in water. DO NOT spray or allow water or the glass cleaner to enter the door vents. DO NOT use oven cleaners, cleaning powders or any harsh abrasive cleaning materials on the outside of the oven door.</p> <p>DO NOT clean the oven door gasket. The oven door gasket is made of a woven material, which is essential for a good seal. Care should be taken not to rub, damage or remove this gasket.</p>

General Care & Cleaning 27

CARE AND CLEANING OF STAINLESS STEEL



Special care and cleaning are **required** for maintaining the appearance of stainless parts. Please refer to the table provided at the beginning of the **General Care & Cleaning** section in this Use & Care Manual.

CLEANING BURNER GRATES, BURNER CAPS AND BURNER HEADS



CAUTION

Do not remove any parts from the cooktop until they have completely cooled and are safe to handle.

IMPORTANT

Do not use spray oven cleaners on the cooktop.

The cooktop is designed to make cleaning easier. Because the gas burner are sealed, cleanups are easy when spillovers are cleaned up immediately.

Cleaning the grates

IMPORTANT

- For proper gas flow and ignition of the burners — **DO NOT allow spills, food, cleaning agents or any other material to enter the gas orifice opening.**
- The cooktop is not removable. Do not attempt to remove or lift the cooktop.

CAUTION

- To avoid possible burns use care when cleaning the cooktop. **DO NOT** attempt to clean the cooktop whenever the cooktop or burner heads are still hot.
- To avoid possible burns **DO NOT** attempt any of the following cleaning instructions provided before turning OFF all of the surface burners and allow them to cool.
- To avoid possible burns **DO NOT** attempt to operate the surface burners without the burner caps.

The burner grates are dishwasher safe and may be cleaned in the dishwasher. Remove any excessive soils before placing in the dishwasher.

Your appliance is shipped with the burner heads and burner caps in the correct locations. Before using your gas appliance be sure to:

- Follow installation instructions before operating.
 - Remove all packing tape from cooktop area.
-

28 General Care & Cleaning

CLEANING COOKTOP, BURNER GRATES, BURNER CAPS AND BURNER HEADS



Burner Caps

Should you ever need to remove the burner caps for cleaning lift the burner cap off the burner head. Clean heavy soils with an absorbent cloth. Rinse with a clean, damp cloth and immediately **thoroughly** dry including the bottom and inside of the cap. Do not use harsh abrasive cleaners. They can scratch the porcelain on the cap. Do not clean burner caps in dishwasher.

When placing the burner caps, see Important note below.

IMPORTANT

When placing the burner caps on the cooktop, be sure the burner caps are seated firmly on top of burner heads. Improper flame size and uneven heating may result when any surface burners are turned ON and the burner caps are not seated correctly.

Double ring burner cap

The glass in the double ring is designed to fit loosely. Clean with normal non abrasive glass type cleaner and thoroughly dry before replacing.

Burner heads

Lift the burner cap from the burner head. The surface burner heads are secured to the cooktop and **must be cleaned in place**.

For proper gas flow it may be necessary to clean the burner heads and slots. To clean, first use a clean DAMP cloth to soak up any spills. Remove any food from between the burner slots using a small nonabrasive brush like a toothbrush and afterwards wipe using a damp cloth. For stubborn soils located in the slots, use a small-gauge wire or needle to clean.

Should you experience ignition problems it may be that an ignition port hole is partially blocked with soil (see figs 1 & 2). With the burner head in place, use a small wire gauge needle or the end of a paper clip to clear the ignition port or ports.

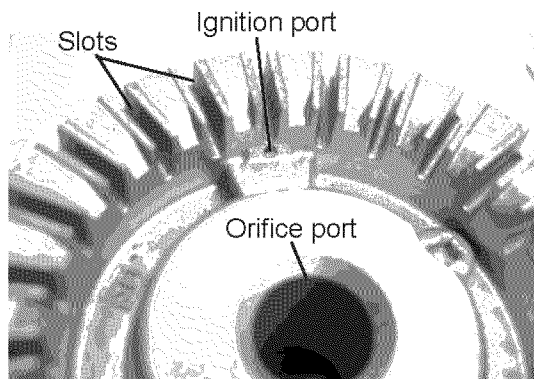

Figure 1 - Cooktop burner head
(All burners except Double ring burner)

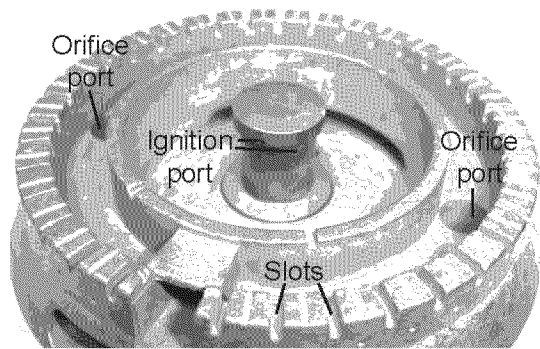

Figure 2 - Double ring burner head
(Models equipped with double ring burner only)

COOKTOP CLEANING AND MAINTENANCE

Prior to using your cooktop for the first time, apply the recommended Cleaning Creme to the ceramic surface. A sample of that cleaning creme is supplied with your appliance and you will find it in store. Clean and buff with a paper towel. This will make cleaning easier when soiled from cooking. The special cooktop cleaning cream leaves a protective finish on the glass to help prevent scratches and abrasions.

Consistent and proper cleaning is essential to maintaining your ceramic glass cooktop

Sliding aluminum or copper clad bottom pans on the cooktop glass can cause metal markings on the cooktop surface. These marks should be removed **immediately** after the cooktop has cooled using the cooktop cleaning cream. Metal marks can become permanent if not removed prior to future use.

Cookware (cast iron, metal, ceramic or glass) with rough bottoms can mark or scratch the cooktop surface. **Do not slide anything metal or glass** across the cooktop. **Do not** use your cooktop as a cutting board or work surface in the kitchen. **Do not** cook foods directly on the cooktop surface without a pan. **Do not** drop heavy or hard objects on the glass cooktop, they may cause it to crack.

CLEANING RECOMMENDATIONS FOR THE CERAMIC GLASS COOKTOP

⚠ CAUTION

Before cleaning the cooktop, be sure the controls are turned to OFF and the cooktop is COOL.

⚠ WARNING

DO NOT use a cooktop cleaner on a hot cooktop. The fumes can be hazardous to your health, and can chemically damage the ceramic-glass surface.

For light to moderate soil:

Apply a few drops of Cleaning Creme directly to the cooktop. Use a paper towel to clean the entire cooktop surface. Make sure the cooktop is cleaned thoroughly, leaving no residue. Do not use the towel you use to clean the cooktop for any other purpose.

For heavy, burned on soil:

First, clean the surface as described above. Then, if soils remain, protect your hand with a potholder and carefully scrape soils with a metal razor blade scraper, holding scraper at a 30 degree angle to the surface. Remove loosened soils with cooktop cleaning cream and buff surface clean.

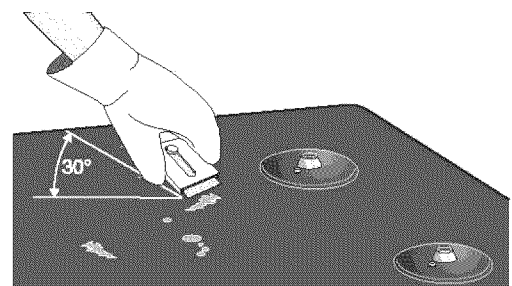

TO REMOVE AND REPLACE OVEN DOOR

- 1. Open the door to the fully opened position.
- 2. Pull up the lock located on each hinge support toward front of range. You may have to apply a little upward pressure on the lock to pull it up.
- 3. Grasp the door by the sides, pull the bottom of the door up and toward you to disengage the hinge supports.
Keep pulling the bottom of the door toward you while rotating the top of the door toward the appliance to completely disengage the hinge levers.
- 4. Proceed in reverse to re-install the door. Make sure the hinge supports are fully engaged before unlocking the hinge levers.

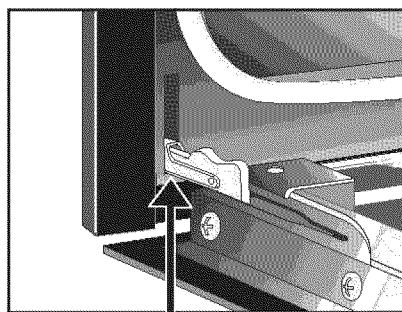

Lock in normal position

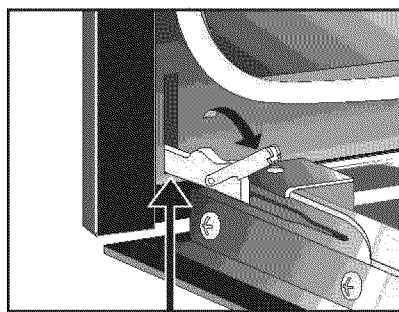

Lock engaged for door removal

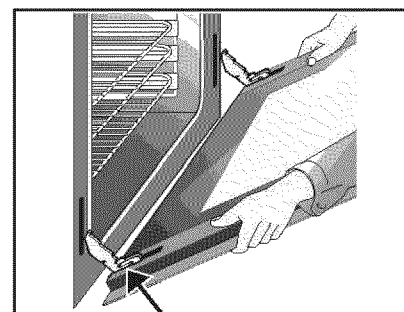

HINGE SLOT - Door removed from the appliance

OVEN LIGHT

An interior oven light will turn automatically when the oven door is opened. The oven light may be turned on when the door is closed by using the oven light switch located on the control panel.

The lamp is covered with a glass shield. The glass shield can be removed to be cleaned manually or to change oven light.

THIS GLASS SHIELD MUST BE IN PLACE WHENEVER THE OVEN IS IN USE.

To replace the light bulb:

CAUTION: BE SURE THE OVEN IS COOL.

- 1. Turn the power off at the main source.
- 2. Wear a leather-faced glove for protection against possible broken glass.
- 3. To remove the glass shield, pull the back side of the shield toward the inside of the oven in a manner to lift it up from the oven side.
- 4. The glass shield should come out easily by pushing a little toward front of the wall oven.
- 5. Replace halogen light appliance bulb taking care to not touch the bulb. If you touch the halogen bulb with finger that can damage it and also burn it.
- 6. To replace glass shield, proceed in reverse.

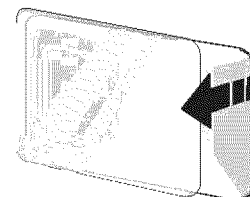

Lift backside of glass shield and remove it.

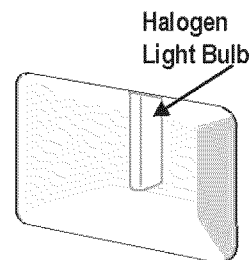

Halogen Light Bulb

32 Solutions to Common Problems

IMPORTANT

Before calling for service, review this list. It may save you both time and expense. This list includes common experiences that are not the result of defective workmanship or material in your cooktop.

SURFACE BURNERS DO NOT LIGHT



- Surface Control knob has not been completely turned to LITE. Push in and turn the Surface Control knob to LITE until burner ignites and then turn control knob to desired flame size.
- Be sure gas supply valve is open.
- Burner ports are clogged. Clean burners. See **Cleaning the Burner Grates, Burner Caps, Burner Heads** in General Care & Cleaning section. With the burner off, clean ports with a small-gauge wire or needle.
- Power cord is disconnected from outlet (Electric Ignition Models only). Be sure cord is securely plugged into the outlet.
- Electrical power outage (electric ignition models only). Burners can be lit manually. See **Setting Surface Controls** in this Use and Care Guide.

BURNER FLAME ONLY LIGHTS HALF WAY AROUND BURNER



- Burner ports are clogged. With the burner off, clean ports by using a small-gauge wire or needle.
- Moisture is present after cleaning. Lightly fan the flame and allow burner to operate until flame is full. Dry the burners thoroughly following instructions in the General Cleaning section.

BURNER FLAME IS ORANGE



- Dust particles in main line. Allow the burner to operate a few minutes until flame turns blue.
- In coastal areas, a slightly orange flame is unavoidable due to salt air.

SCRATCHES OR ABRASIONS ON CERAMIC GLASS COOKTOP SURFACE



- Coarse particles (such as salt or sand) are between cooktop and utensil. Be sure cooktop surface and bottom of utensils are clean before use. Small scratches do not affect cooking and will become less visible with use.
 - Cleaning materials not recommended for glass ceramic cooktop have been used. See **Ceramic-Glass Cooktop** section in this Owner's Guide.
-

METAL MARKS ON CERAMIC GLASS COOKTOP SURFACE



- Sliding or scraping of metal utensils on cooktop surface. Do not slide metal utensils on cooktop surface. Use a mildly abrasive cleanser to remove marks.

BROWN STREAKS AND SPECKS ON CERAMIC GLASS COOKTOP SURFACE



- Boilovers have cooked onto surface. Use razor blade scraper to remove soil. See instructions under **General Care & Cleaning**.
- Cleaning materials not recommended for ceramic-glass cooktop have been used. Use recommended cleaners and cleaning method. See **Ceramic-Glass Cooktop** section in this Owner's Guide.

AREAS OF DISCOLORATION ON CERAMIC GLASS COOKTOP SURFACE



- Mineral deposits from water and food. Wet surface with water and sprinkle on a cooktop cleaning creme. Scrub with a clean damp paper towel until the stain disappears. Wipe remaining paste away, then apply a small amount of cooktop cleaning creme and polish with a clean paper towel. Use cookware with clean, dry bottoms. See **Ceramic-Glass Cooktop** section in this Owner's Guide.

APPLIANCE NOT LEVEL



- Place oven rack in center of oven. Place a level on the oven rack. Contact installing agent if rack and cabinet cutout flooring are not level.
- Kitchen cabinet misalignment may make oven appear to be not level. Be sure cabinets are square and level. Contact cabinet maker to correct problem.

POOR BAKING RESULTS



- Many factors affect baking results. See **Baking** for hints, causes and corrections.

34 Solutions to Common Problems

ENTIRE OVEN DOES NOT OPERATE



- When the unit is first plugged in, or when the power supply to the range has been interrupted, the indicator lights will flash and the control will beep. To stop the lights from flashing, turn the selector control knob to BAKE and back to OFF. The oven cannot be used until this step is followed.
- Be sure electrical cord is securely connected into the electrical junction box.
- Cord/plug is not installed and/or connected. Cord is not supplied with oven. Contact a qualified servicer.
- Service wiring not complete. Contact a qualified servicer.
- Power outage. Check house lights to be sure. Call your local electric company.
- Short in cord/plug. Replace cord/plug.
- Controls are not set properly. See instructions under **Setting Oven Controls** to set the controls.
- House fuse has blown or circuit breaker has tripped immediately following installation. House fuse may not be fully engaged. Check fuse and screw or engage circuit breaker securely.
- House fuse has blown or circuit breaker has tripped after the oven has been installed and previously operating. Contact a qualified servicer.

OVEN LIGHT DOES NOT WORK



- Burned-out or loose bulb. Follow the instructions under **Changing Oven Light** to replace or tighten the bulb.

FAN NOISE DURING COOKING OPERATION



- A cooling fan may automatically turn on and off to cool internal parts. This is normal, and the fan may continue to run even after oven is turned off.

OVEN SMOKES EXCESSIVELY DURING BROILING



- Meat too close to the broiler unit. Reposition the rack to provide more clearance between the meat and the broiler. Preheat broil element for quick searing operation.
 - Meat not properly prepared. Remove excess fat from meat. Slash remaining fatty edges to prevent curling, but do not cut into the lean.
 - Grid on broiler pan wrong-side up. Grease does not drain into broiler pan. Always place the grid on the broiler pan with the ribs up and the slots down to allow grease to drip into the pan.
 - Broiler pan used without grid or grid cover with foil. **DO NOT** use the broiler pan without the grid or cover the grid with foil.
 - Oven needs to be cleaned. Grease has built up on oven surfaces. Regular cleaning is necessary when broiling frequently. Old grease or food spatters cause excessive smoking.
-

SELF-CLEANING CYCLE DOES NOT WORK



- Make sure the oven door is closed.
- Make sure the two oven rack ladders are removed from the oven.
- Controls not set properly. Follow instructions.
- Self-cleaning cycle was interrupted. Start a clean again, wait 20 seconds for the Lock light to stop flashing, turn off the clean and wait again 20 seconds for the light to turn off.

SOIL NOT COMPLETELY REMOVED AFTER SELF-CLEANING CYCLE IS COMPLETED



- Failure to hand clean oven frame and door liner outside the oven door gasket before starting the self-clean cycle. Hand clean burned on residue with a stiff nylon brush and water or a nylon scrubber. Do not clean the oven door gasket or it will be damaged.

FLAMES INSIDE OVEN OR SMOKE FROM VENT



- Excessive spillovers in oven. This is normal, especially for high oven temperatures, pie spillovers or for large amounts of grease on bottom of oven. Wipe up excessive spillovers.



36 Warranty Information

APPLIANCE WARRANTY

Your range is protected by this warranty

	WARRANTY PERIOD	THROUGH OUR AUTHORIZED SERVICERS, WE WILL	THE CONSUMER WILL BE RESPONSIBLE FOR:
FULL ONE-YEAR WARRANTY	One year from original purchase date.	Pay all costs for repairing or replacing any parts on the appliance which prove to be defective in materials or workmanship.	Costs of service calls that are listed under NORMAL RESPONSIBILITIES OF THE CONSUMER.*
LIMITED WARRANTY (Applicable to the State of Alaska)	Time periods listed above.	All of the provisions of the full warranties above and the exclusions listed below apply.	Costs of the technician's travel to the home and any costs for pick up and delivery of the appliance required because of service.

In the U.S.A., your appliance is warranted by Electrolux Home Products North America, a division of White Consolidated Industries, Inc. We authorize no person to change or add to any of our obligations under this warranty. Our obligations for service and parts under this warranty must be performed by us or an authorized Electrolux Home Products North America servicer. In Canada, your appliance is warranted by Electrolux Canada Corp.

***NORMAL RESPONSIBILITIES OF THE CONSUMER** This warranty applies only to products in ordinary household use, and the consumer is responsible for the items listed below:

1. Proper use of the appliance in accordance with instructions provided with the product.
2. Proper installation by an authorized servicer in accordance with instructions provided with the appliance and in accordance with all local plumbing, electrical and/or gas codes.
3. Proper connection to a grounded power supply of sufficient voltage, replacement of blown fuses, repair of loose connections or defects in house wiring.
4. Expenses for making the appliance accessible for servicing, such as removal of trim, cupboards, shelves, etc., which are not a part of the appliance when it was shipped from the factory.
5. Damages to finish after installation.
6. Replacement of light bulbs and/or fluorescent tubes (on models with these features).

EXCLUSIONS This warranty does not cover the following:

1. CONSEQUENTIAL OR INCIDENTAL DAMAGES SUCH AS PROPERTY DAMAGE AND INCIDENTAL EXPENSES RESULTING FROM ANY BREACH OF THIS WRITTEN OR ANY IMPLIED WARRANTY.
NOTE: Some states do not allow the exclusion or limitation of incidental or consequential damages, so this limitation or exclusion may not apply to you.
2. Service calls which do not involve malfunction or defects in workmanship or material, or for appliances not in ordinary household use. The consumer shall pay for such service calls.
3. Damages caused by services performed by servicers other than Electrolux Home Products North America or its authorized servicers; use of parts other than genuine Electrolux Home Products parts; obtained from persons other than such servicers; or external causes such as abuse, misuse, inadequate power supply or acts of God.
4. Products with original serial numbers that have been removed or altered and cannot be readily determined.

IF YOU NEED SERVICE

Keep your bill of sale, delivery slip, or some other appropriate payment record. The date on the bill establishes the warranty period should service be required. If service is performed, it is in your best interest to obtain and keep all receipts. This written warranty gives you specific legal rights. You may also have other rights that vary from state to state. Service under this warranty must be obtained by contacting Electrolux Home Products:

USA
1•800•944•9044
 Electrolux Home Products
 North America
 P.O. Box 212378
 Augusta, GA 30917

Canada
1•866•294•9911
 Electrolux Home Products
 North America
 802, boul. L'Ange-Gardien
 L'Assomption, Québec
 J5W 1T6

This warranty only applies in the 50 states of the U.S.A., Puerto Rico, and Canada. Product features or specifications as described or illustrated are subject to change without notice. All warranties are made by Electrolux Home Products North America, a division of White Consolidated Industries, Inc. In Canada, your appliance is warranted by Electrolux Canada Corp.