

VIORÉ™ TECHNOLOGY & INNOVATION

OPERATING INSTRUCTIONS

32" HD LCD Television LC32VH56



AIR (TV)/CABLE MODE SELECTION

The Air/CABLE menu option is set to the "CABLE" (Cable Television) mode at the factory. If you want to use an antenna for the built-in TV tuner, this menu option must be set to the "Air" mode. Please refer to "6. Channel MENU" in page 14 of this manual for the details.

STOP

FOR QUESTIONS OR TECHNICAL SUPPORT

Please call:

1-877-777-1428 (USA / PUERTO RICO)

1-877-777-1429 (CANADA)

Please do not return this TV to the store.

Contents

Safety and warnings.....	2-4
Introduction.....	5
Installation.....	6-9
Remote Control.....	10
Operation.....	11-14
Trouble Shooting.....	15

SAFETY AND WARNINGS

IMPORTANT SAFETY INSTRUCTION

1. Read these safety instructions.
2. Keep these safety instructions.
3. Heed all warnings.
4. Follow all safety instructions.
5. Do not use this apparatus near water.
6. Clean only with dry cloth.
7. Do not block any ventilation openings. Install in accordance with the manufacturers instructions.
8. Do not install near any heat sources such as radiators , stoves, or other apparatus (including amplifiers)that produce heat.
9. Protect the power cord from being walked on or pinched particularly at power outlets, and the point where they exit from the apparatus.
10. Only use attachments/accessories specified by the manufacturer.
11. Unplug this apparatus during lightning storms or when unused for long periods of time.
12. Refer all servicing to qualified service personnel. Servicing is required when the apparatus has been damaged in any way, such as the power-supply cord or plug is damaged, liquid has been spilled or objects have fallen into the apparatus, the apparatus has been exposed to rain or moisture , does not operate normally, or has been dropped.
13. Apparatus must not be exposed to dripping or splashing and no objects filled with liquids, such as vases, should be placed on the apparatus.

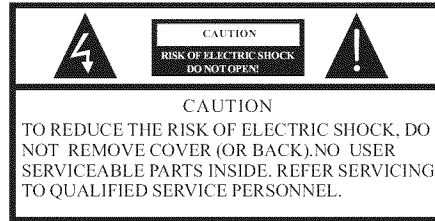

 The symbol indicates that dangerous voltages constituting a risk of electric shock are present within this unit.

 The symbol indicates that there are important operating and maintenance instructions in the literature accompanying this unit.

WARNING:

To prevent fire or shock hazard, do not expose this appliance to rain or moisture.

SAFETY AND WARNINGS

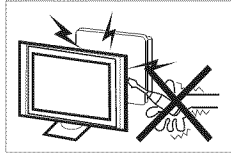

High voltages are used in the operation of this television receiver. Do not remove the cabinet back from your set. Refer servicing to qualified service personnel.

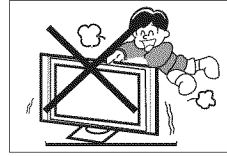

Never stand on, lean on, or suddenly push the television or its stand. You should pay special attention to children. Serious injury may result if it falls.

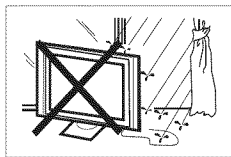

To prevent fire or electrical shock hazard, do not expose the television receiver to rain or moisture.

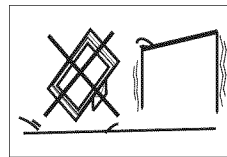

Do not place your television on an unstable cart, stand, shelf or table. Serious injury to an individual, and damage to the television, may result if it falls.



Do not drop or push objects into the television cabinet slots or openings. Never spill any kind of liquid on the television receiver.

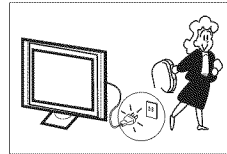

When the television receiver is not used for an extended period of time, it is advisable to disconnect the AC power cord from the AC outlet.



Do not block the ventilation holes in the back cover. Adequate ventilation is essential to prevent failure of electrical components.

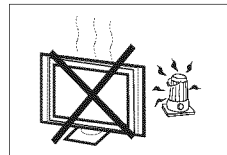

Avoid exposing the television receiver to direct sunlight and other sources of heat. Do not stand the television receiver directly on other products which give off heat, e.g. video cassette players and audio amplifiers. Do not place naked flame sources, such as lighted candles on the television.

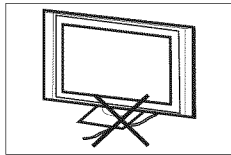

Do not trap the power supply cord under the television receiver.

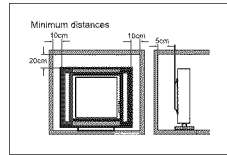

If the television is to be built into a compartment or similar enclosure, the minimum distances must be maintained. Heat build-up can reduce the service life of your television, and can also be dangerous.

SAFETY AND WARNINGS

Thank you very much for purchasing this TV. To enjoy your product from the very beginning, read this manual carefully and keep it handy for easy reference.



INSTALLATION

- Locate the TV in the room where light does not strike the screen directly.
- Total darkness or a reflection on the picture screen can cause eyestrain. Soft and indirect lighting is recommended for comfortable viewing.
- Allow enough space between the TV and the wall to permit ventilation.
- Avoid extremely warm locations to prevent possible damage to the cabinet or premature component failure.
- This TV can be connected to AC 100-240 Volts, 50/60 Hz. Never connect to a DC supply or any other power supply.
- Do not cover the ventilation openings when using the TV.

CAUTION

Never tamper with any components inside the TV, or any other adjustment controls not mentioned in this manual. All LCD-TV's are high voltage instruments. When you clean up dust or water drops on the LCD PANEL or CABINET, the power cord should be pulled out from the receptacle, then wipe the TV with a dry soft cloth. During thunder and lightning, unplug the power cord and antenna cord to prevent damage to your TV. All repairs to this TV should only be performed by qualified TV service personnel.

Earthing connection--- The apparatus shall be connected to MAINS socket outlet with a protective earthing connection. MAINS plug or appliance coupler of the apparatus is used as disconnect device, it should remain readily operable.

Warning: Change or modifications to this unit not expressly by the part responsible for compliance could void the user's authority to operate the Equipment.

NOTE:

This equipment has been tested and found to comply with the limits for a Class B digital device, pursuant to Part 15 of the FCC Rules. These limits are designed to provide reasonable protection against harmful interference in a residential installation. This equipment generates, uses, and can radiate radio frequency energy and, if not installed and used in accordance with the instructions, may cause harmful interference will not occur in a particular installation. If this equipment does cause harmful interference to radio or

television reception, which can be determined by turning the equipment off and on, the user is encouraged to try to correct the interference by one or more of the following measures:

- Reorient or relocate the receiving antenna.
- Increase the separation between the equipment and receiver.
- Connect the equipment into an outlet on a circuit different from that to which the receiver is connected.
- Consult the dealer or an experienced radio TV technician for help.

Shield cables must be used with this unit to ensure compliance with the Class B FCC limits.



This symbol indicates that this product incorporates double insulation between hazardous mains voltage and user accessible parts. When servicing use only identical replacement parts.
WARNING: To reduce the risk of fire or electric shock, do not expose this apparatus to rain or cords.

INTRODUCTION

Main features

- 1366 x 768 native resolution for HD performance
- Integrated ATSC TV tuner for HDTV broadcast reception
- High brightness provides a vivid and brilliant picture
- Deeper blacks and brighter whites with high contrast
- Wide Screen aspect ratio (16:9) for a complete home theater experience
- HDMI input for true digital connection
- VGA port for connection to PC
- Built-in stereo speaker system
- Full-function Remote Control

Accessories

AC Power Cord.....	1
Infrared Remote Control.....	1
User's Manual	1
Battery(AAA).....	2

Main parameter

Viewing Picture Size(diagonal)	32inch
Resolution:	1366x768
Aspect Ratio:	16:9
TV System:	ATSC Digital system and NTSC Analog system
Video Signal System:	NTSC/PAL/SECAM
Receiving Channel:	Cable :1-135/ Air: 2-69(ATV&DTV)
Power consumption:	170W
Input Power Voltage:	AC 100V-240V 50/60Hz
Audio Output Power(THD ≤ 7%):	2x8W
Rear High-Definition Multimedia Interface(HDMI) Input	x 2
Rear S-Video Input	x 1
Side HDMI Input	x 1
YCb(Pb)Cr(Pr) Input	x 1
Rear Analog Audio Output	x 1
Rear Coaxial SPDIF Output	x 1
Analog RGB(VGA) Input	x 1
Rear Composite Video Input	x 1
Rear Audio Input	x 3
Side Composite Video Input	x 1
Side HEAD PHONE Output	x 1
Rear Composite Video Output	x 1
Horizontal definition(TV line)	Composite Video Input ≥350 Video Input ≥400 YCb(Pb)Cr(Pr) ≥400

Front panel

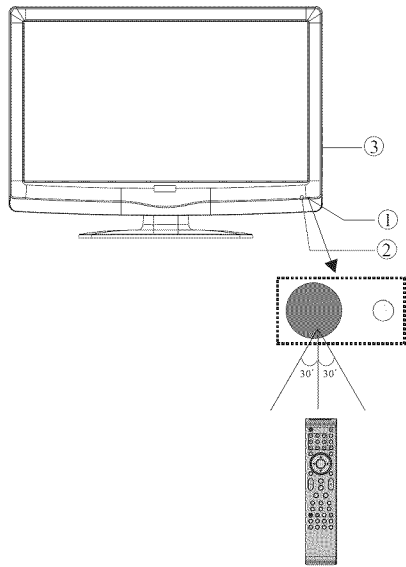

- 1: Remote control sensor.
- 2: Indicator LED: GREEN ● POWER ON.
RED ● STANDBY.
- 3: Key board

Side panel

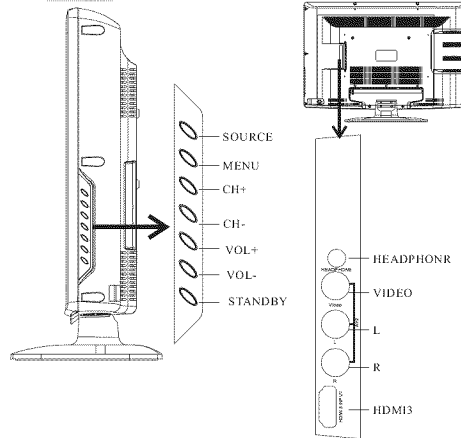

- 1. **SOURCE**: Display the input source menu.
- 2. **MENU**: Display main MENU.
- 3. **CH+/CH-**:In TV mode, press “CH+” or “CH-” to change the channel up and down.In MENU mode, press “CH+” or “CH-” to select items .In standby mode, press “CH+” or “CH-” to turn on the TV.
- 4. **VOL+/VOL-**:Adjust sound level.In MENU mode, press “VOL+” or “VOL-” to adjust the item that you selected.
- 5. **STANDBY** : Press this button to turn the unit ON from STANDBY mode. Press it again to turn the set back to STANDBY.
- 6.**HEADPHONE OUTPUT**
- 7.**VIDEO INPUT**
- 8.**AUDIO INPUT-L**
- 9.**AUDIO INPUT-R**
- 10.**HDMI3 INPUT**

REAR AV Connection

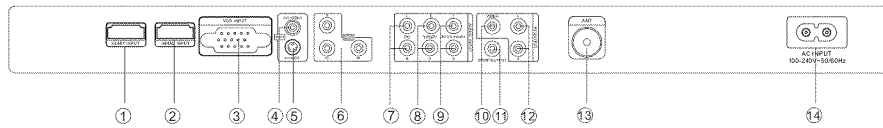

- 1. HDMI1 INPUT
- 2. HDMI2 INPUT
- 3. VGA INPUT
- 4. AV1 INPUT
- 5. S-VIDEO INPUT
- 6. YPbPr INPUT
- 7. PC AUDIO INPUT
- 8. YPbPr AUDIO INPUT
- 9. AV1/S-VIDEO AUDIO INPUT
- 10. VIDEO OUTPUT
- 11. SPDIF OUTPUT
- 12. AUDIO OUTPUT
- 13. ANT
- 14. AC POWER INPUT

Note:

- 1. AV1 and S-VIDEO share one audio channel.
 - 2. When HDMI1 port get DVI signal, the “PC Audio” channel will change to receive the audio from HDMI1 port
 - 3. When HDMI2 port get DVI signal, the “YPbPr Audio” channel will change to receive the audio from HDMI2 port.
 - 4. AV OUTPUT :
- When the source are AV1, AV2(side) S-VIDEO, ATV, the AV OUTPUT Channel reproduce the input signals accordingly



STEPS:

Be sure both the TV and computer are set to Power off.

1. Connect VGA and audio cable.
2. Connect the power cord.
3. Power on the TV, switch to VGA mode.
4. Power on the VGA.

This sequence is very important.

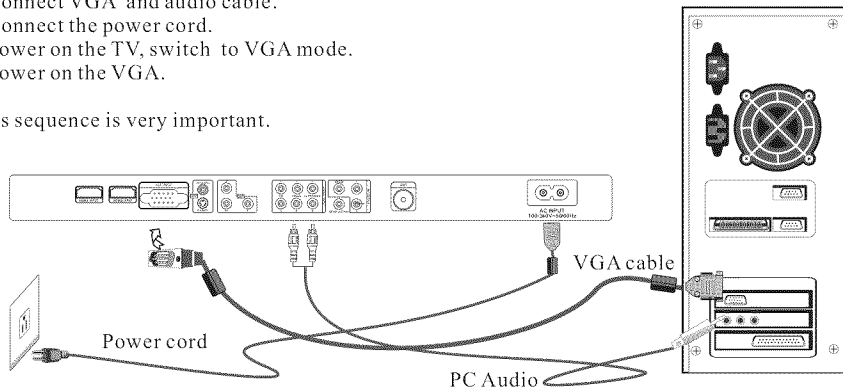

PRESET MODE

	RESOLUTION	V.Freq.(Hz)	H.Freq.(KHz)
1	720*400	70	31.47
2	640*480	60	31.47
3	640*480	72	37.86
4	640*480	75	37.50
5	800*600	56	35.156
6	800*600	60	37.88
7	800*600	72	48.08
8	800*600	75	46.88
9	1024*768	60	48.36
10	1024*768	70	56.48
11	1024*768	75	60.02
12	1280*1024	60	63.98
13	1280*1024	75	80.00

ANTENNA

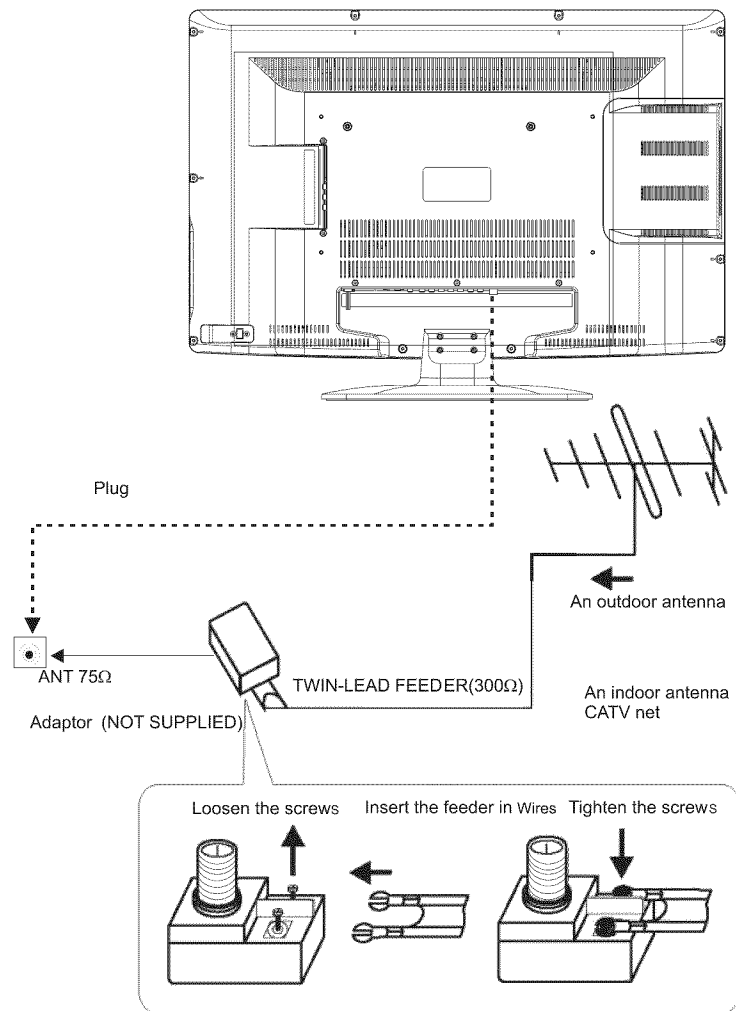

Note:
Aerial connections:IEC(female).
Input impedance:75 Ω unbalanced.

AV EQUIPMENT

This TV provides two groups of AV ,one S-Video,one group of YPbPr for convenient connection to VCR,DVD or other video equipment,three group of HDMI for HD signal input Please refer to the owner's manual of the equipment to be connected as well.

You can use the input terminals on TV set rear as follows.

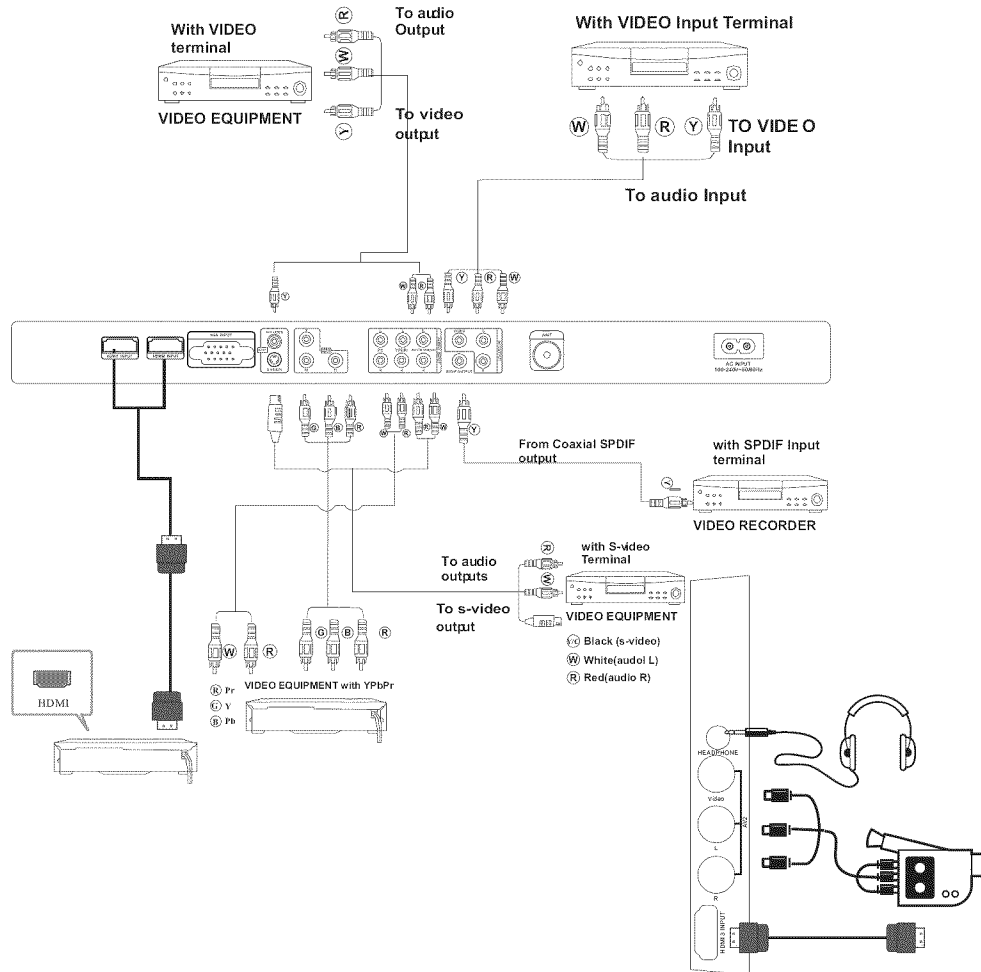

It can be connected to the following appliances: VCR, multi disc player, DVD, camcorder, video game or stereo system, etc....

YPbPr can support these video fomats:480i,576i,480p,576p,720p,1080i,1080p.

NOTE:

When HDMI3 port get DVI signal, the "AV2 Audio" channel will change to receive the audio from HDMI3 port.

REMOTE CONTROL

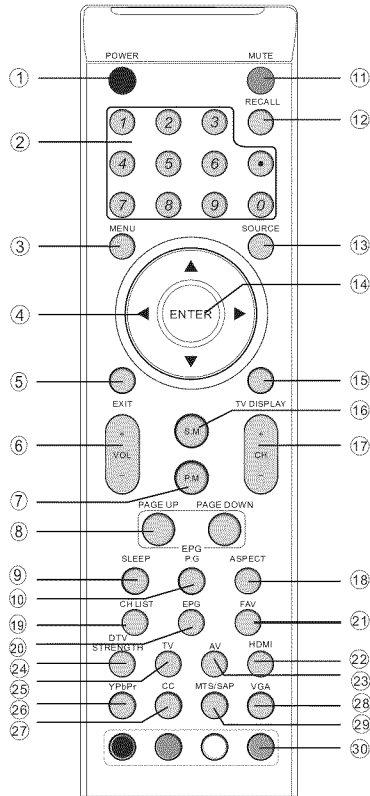

- 1: **POWER**
To set the TV standby or on.
- 2: **NUMBER KEY**
For direct access to program.
- 3: **MENU**
To display TV menu or to return to the previous menu.
- 4: **CURSOR**
To move within the menu.
- 5: **EXIT**
Used to exit menu.
- 6: **VOL +/-**
To adjust sound level.
- 7: **P.M**
To switch picture mode.
- 8: **PAGE DOWN/PAGE UP**
In EPG mode, use this key to page up/down the EPG information.
- 9: **SLEEP**
Set time to turn off the TV.
- 10: **P.G**
Setting the Parental Control level control.
- 11: **MUTE**
To disable or enable the sound.
- 12: **RECALL**
To access the previously viewed program.
- 13: **SOURCE**
To display or exit TV input source menu.
- 14: **ENTER**
Confirms selection.
- 15: **TV DISPLAY**
Displays/removes the program Information
- 16: **S.M**
To switch sound mode.
- 17: **CH +/-**
To access the next or previous Program.
- 18: **ASPECT**
To change picture aspect .
- 19: **CH LIST**
Used to display the channel list.
- 20: **EPG**
Display all the information of DTV programs.
- 21: **FAV**
Used to access your favourite channels in digital TV mode.
- 22: **HDMI**
Hot key directly go to HDMI source.
- 23: **AV**
Hot key directly go to AV source.
- 24: **DTV STRENGTH**
Used to display the DTV signal strength menu.
- 25: **TV**
Hot key directly go to TV source.
- 26: **YPbPr**
Hot key directly go to YPbPr source.
- 27: **CC**
Enable or disable the CC function.
- 28: **VGA**
Hot key directly go to VGA source.
- 29: **MTS/SAP**
Switch the sound stereo, SAP and mono.
- 30: **COLOR KEYS**
Reserved keys

Insert Batteries Into the Remote Control

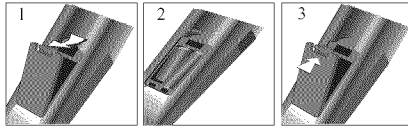

1. Remove the battery cover.
2. Inserting the 2 AAA 1.5V batteries making sure the polarity (+ or -) of the batteries matches the polarity marks inside the unit.
3. Mount the battery cover.
Replace with new batteries when the TV set begins to show the following symptoms:
Operation is unsteady or erratic. Sometimes the TV set does not function with Remote Control Unit.

Remark:

- 1) Alkaline Battery Recommended.
- 2) Remove batteries when they are exhausted or if the remote control is not to be used for long time.

1. PICTURE MENU

The first item of the MENU is PICTURE MENU.
You can adjust picture effect here, such as contrast, brightness, etc.
Press ▼▲ to select, press ◀▶ to adjust, press MENU to exit.

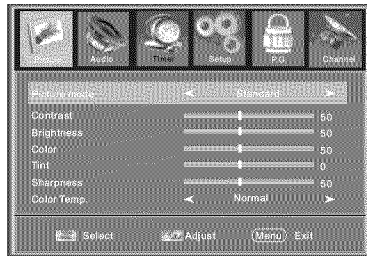

Note:
If you want to adjust contrast, brightness, color, and sharpness, the picture mode must return to "personal" status.

2. AUDIO menu

The second item of the MENU is AUDIO MENU.
You can adjust sound here.
Press ▼▲ to select, press ◀▶ to adjust, press MENU to exit.

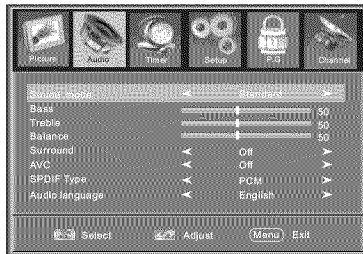

Note:
The item of Audio language is available in ATSC program.

3. TIMER MENU

The third item of the MENU is TIMER MENU.
You can adjust time here.
Press ▼▲ to select, press ◀▶ to adjust, press MENU to exit.

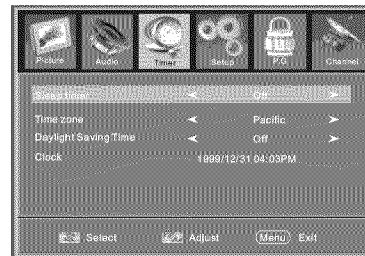

1). Sleep Timer: adjust this item, you can set the sleep timer.

Note:
The item of Time zone, the item of Daylight Saving Time and the item of Clock are available in ATSC program

4. SETUP MENU

The forth item of the MENU is SETUP MENU.
You can setup system here.
Press ▼▲ to select, press ◀▶ to adjust, press MENU to exit.

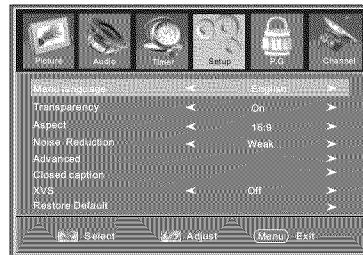

Note:
Restore Default: Reset all the settings to default value.

1). Advanced: In PC Mode is available.

Press ▼▲ button to select Advanced item , Press ► button, the screen will display as follow:

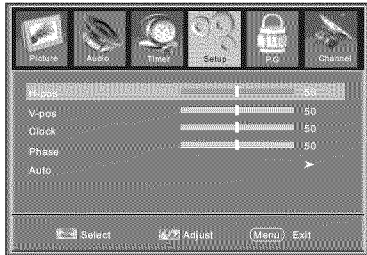

- (1).H-Pos:Adjust the horizontal position of the screen.
- (2).V-Pos:Adjust the vertical position of the screen.
- (3).Clock: Fine tune the screen width.
- (4).Phase: Fine tune the phase of the screen. Usually don't adjust this item.
- (5).Auto: Auto adjust to fit the screen.

2). Closed Caption: switch close caption mode.

Press ▼▲ button to select Closed Caption item, Press ► button, the screen will display as follow:



- (1):Advanced Selection: only ATSC program is available.
- (2):Option:Used to edit CC font.

Press ► button, the screen will display as follow:

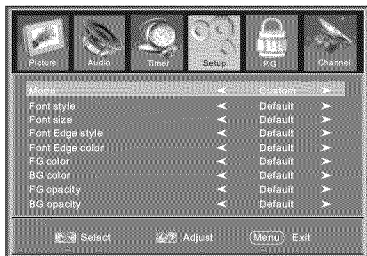

NOTE: Only ATSC program is available.

5. P.G MENU

The fifth item of the MENU is P.G MENU. You can setup Parental Control here.

Press ▼▲ to select, press ◀▶ to adjust, press MENU to exit.

Parent Control: input the password, it will go into Parental Control menu. Factory default password is 6666.

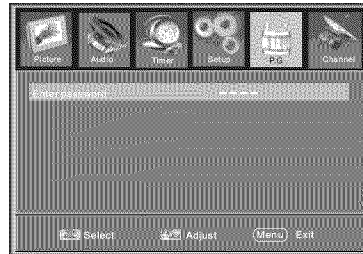

5.1 .Input the correct password ,the screen will display as follow:



1). Change Password: Press ► button, the screen will display as follow:



- 1).New Password: Input the new password
- 2).Confirm Password: Input the new password again

5.2 P.G switch:

When the Parental Control switch is ON, the below options can be adjusted.

5.3 US: Press ► button, the screen will display as follow:

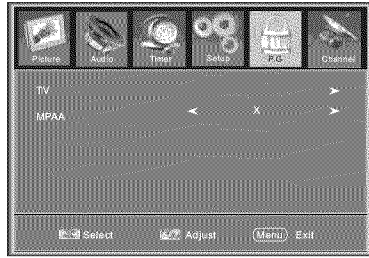

1):TV: Press ► button, the screen will display as follow:

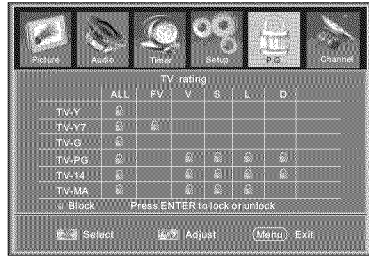

Rating	Content	Content				
		FV (Fantasy violence)	V (Violence)	S (Sexual situation)	L (Adult language)	D (Sexually suggestive dialog)
Suggested age	TV-Y (All children)					
	TV-Y7(Direct to order children)	X				
	TV-G(General audience)					
	TV-PG(Parental Guidance suggested)		X	X	X	X
	TV-14(Parents strongly cautioned)		X	X	X	X
TV-MA(Mature audience only)		X	X	X		

And use ENTER key to switch lock/ unlock Parental Control feature.

2).MPAA:switch the movie-rating control level: N/A, G, PG, PG-13,R,NC-17,X.

Rating	Description	
Age	G	General audiences, All Ages admitted
	PG	Parental Guidance suggested. Some material may not be Suitable for children.
	PG-13	Parents strongly cautioned. Some material may be Inappropriate for children under 13.
	R	Restrict. Under 17 requires accompanying parent or adult guardian(age varies in some jurisdictions)
	NC-17	No one 17 and under admitted.
X	X is an order rating that is unified with NC-17 but may be encoded in the data of order movies.	

5.4 Canada: Press ► button, the screen will be displayed as follow:



1): Canada English: switch the english rating control level:E,C,C8+,G,PG,14+,18+.

Rating	Description	
E	Exempt: Includes news, sports, documents and other information programming: talk shows, music videos, and variety programming.	
C	Children: Intended for younger children under the age of 8 years. Pays careful attention to themes that could threaten their sense of security and well-being.	
C8+	Children over 8 years old: Contains no portrayal of violence as the preferred, acceptable, or only way to resolve conflict; nor encourage children to imitate dangerous acts which they may see on the screen.	
Age	G	General: Considered acceptable for all age groups. Appropriate viewing for the entire family, contains very little violence, physical, verbal or emotional.
	PG	Parental Guidance: Intended for a general audience, but may not be suitable for younger children (under the age of 8) because it could contain controversial themes or issues.
	14+	Over 14 Years: Could contain themes where violence is one of the dominant elements of the storyline But it must be integral to the development of plot or character. Language usage could be profane and nudity, present within the context of theme.
18+	Adults: Intended for viewers 18 years and older and might contain depictions of violence, which while related to the development of plot, character or themes, are intended for adult viewing. Could contain graphic language and portrayals of secretary and nudity.	

2).Canada French: switch the French-rating control level: E, G,8ANS+,13 ANS+,16ANS+,18ANS+.

Rating	Description
E	Exempt programming
G	General :All ages and children, contains minimal direct violence, but may be integrated into the plot in a humorous or unrealistic manner .
8ans+	General but inadvisable for young children :May be viewed by a wide public audience, but could contain scenes disturbing to children under 8 who cannot distinguish between imaginary and real situations. Recommended for viewing with parent.
13ans+	Over 13 years: Could contain scenes of frequent violent scenes and in tense violence.
16ans+	Over 16 years: Could contain frequent violent scenes and violence.
18ans+	Over 18 years: Only for adult viewing. Could contain frequent violent scenes and extreme violence.

5.5 RRT Setting: in ATSC digital TV mode, it could be adjusted

5.6 Reset RRT: Press ► button, the screen will be displayed as follow:

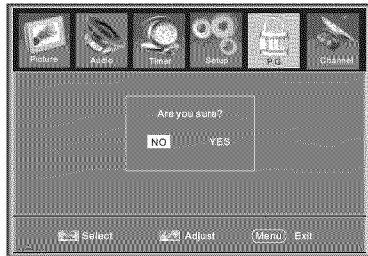

6. Channel MENU

The sixth item of the MENU is CHANNEL MENU. You can adjust digital and analog TV channel here . Press ▼▲ to move, press ◀▶ to adjust.



- 1). Air/Cable: select air TV signal or cable TV signal.
- 2). Auto Scan: If it's the first time using the TV, it should scan all the TV channels first, press the ► button to confirm, you will see below menu :

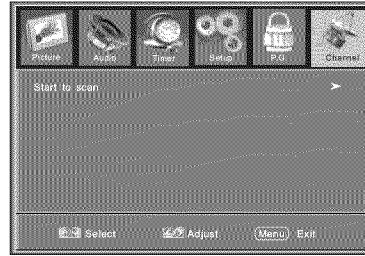



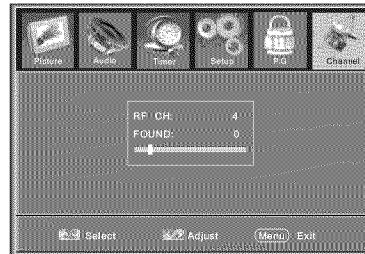













A: Start to Scan: press the ► button to confirm, you will see below menu which indicates auto search is in process.

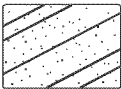

- 3). Favorite: Press ◀▶ button to choose/delete the favorite channel .
- 4). Show/Hide: Press ◀▶ button to display or hide currently channel.
- 5). Channel NO. :Display the currently channel number.
- 6). Channel Label: Press▲▼ button to edit currently channel name.
- 7). DTV Signal: Display DTV signal intension. It can't be selected and adjusted.

Trouble shooting

Trouble phenomenon Symptom		Inspection Check
Picture	Audio	
 Snow	 Noise	antenna position, direction or connection
 Ghost	 Normal audio	antenna position, direction or connection
 Interference	 Noise	electronic equipment, car/ motorcycle, fluorescent light
 Normal Picture	 Mute	Volume (check if mute is activated or if the audio system connections are not correct)
 No picture	 Mute	Power cord is not inserted Power switch is not opened Contrast and brightness/volume setup Press standby key on the remote control for inspecting
 No colour	 Normal audio	Colour control
 Picture breaking up	 Normal audio or weak	retune channel
 No colour	 Noise	TV system

The LCDTV panel is built with very high precision technology giving you fine picture details in vibrant color. Occasionally, a few non-active pixels may appear on the screen as a fixed point of red, green, blue, black or white. Please note this does not affect the performance of the product.

Viore, Inc.
7801 Hayvenhurst Avenue, Van Nuys, CA 91406

Printed in China