

VIORE™ TECHNOLOGY & INNOVATION

OPERATING INSTRUCTIONS

22" 1080p LCD Television *LC22VF59*

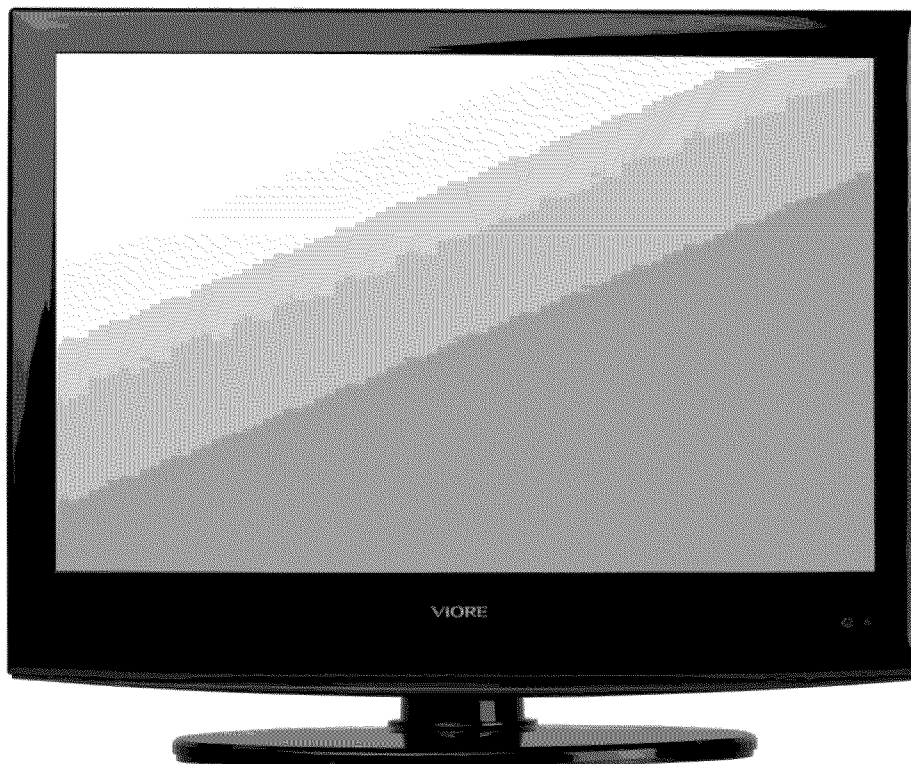

AIR (TV)/CABLE MODE SELECTION

The Air/CABLE menu option is set to the "CABLE" (Cable Television) mode at the factory. If you want to use an antenna for the built-in TV tuner, this menu option must be set to the "Air" mode. Please refer to page 19 of the owner's manual for the details of this menu.

FOR QUESTIONS OR TECHNICAL SUPPORT

Please call: 1-877-777-1428

Please do not return this TV to the store.

Contents

Caution	2
Safety Information	3
Unit and Accessories	4
Product Feature	4
Introduction	5-8
1. Front View	5
2. Rear View	6
3. Remote Control	7-8
Connection	9-11
Basic Operation	12-13
OSD Menu	14-20
1. Picture menu	14
2. Audio menu	15
3. Time menu	16
4. Setup menu	17
5. Lock menu	18
6. Channel menu	19-20
Simple Troubleshooting	21
Technical Specifications	22

Caution



The lightning flash with arrowhead symbol, within an equilateral triangle is intended to alert the user to the presence of un-insulated "dangerous voltage" within the products enclosure that may be of sufficient magnitude to constitute a risk of electric shock to the persons.



The exclamation point within an equilateral triangle is intend to alert the user to the presence of important operating and maintenance (servicing) instructions in the literature accompanying the appliance.



Correct disposal of this Product

(Waste Electrical & Electronic Equipment (WEEE))

Your product is designed and manufactured with high quality materials and components which can be recycled and reused.

This symbol means that electrical and electronic equipment, at their end-of-life should be disposed of separately from your household waste.

Please dispose of this equipment at your local community waste collection/ recycling centre.

In the USA there are separate collection systems for used electrical and electronic products. Please help us to conserve the environment we live in!

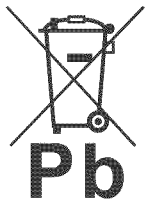

This unit complies with America Safety directives.

3124140
CONFORMS TO UL STD. 60065



This unit complies with FCC directives.

Safety Information

To ensure reliable and safe operation of this equipment, please read carefully all the instructions in this user guide, especially the safety information below.

Electrical safety

- The TV set should only be connected to a mains supply which matches that stated on the label on the mains adaptor
- To prevent overload, don't share the same mains supply socket with too many other items of equipment.
 - Do not place any connecting wires where they may be stepped on or tripped over.
 - Do not place heavy items on the leads, which may damage them.
 - Hold the Mains plug, not the wires, when removing from a socket.
 - During a thunderstorm or while leaving the TV for long periods, disconnect the aerial (if outdoor) and mains adaptor from the supply.
 - Do not allow water or moisture to enter the TV or mains adaptor. Do NOT use in wet or moist areas such as Bathrooms, steamy kitchens or near swimming pools.
- Pull the plug out immediately, and seek professional help if:
 - the mains plug or cable is damaged
 - liquid is spilt onto the set, or if it is accidentally exposed to water or moisture
 - anything accidentally penetrates the ventilation slots
 - the set does not work normally.
 - Do NOT remove the safety covers. There are no user serviceable parts inside. You may invalidate the warranty. Qualified personnel only are permitted to service this apparatus.
 - To avoid battery leakage, remove exhausted batteries from the remote control handset, or when not using for along period.
 - Do NOT break open or throw exhausted batteries on a fire.

Physical safety

- Do NOT block ventilation slots in the back cover. You may place the TV in a cabinet, but ensure at least 5cm (2") clearance all around the unit.
- Do NOT tap or shake the TV screen, you may damage the internal circuitry. Take good care of the remote control, do not drop it or allow it to come into contact with liquids.
- To clean the TV use a soft dry cloth. Do NOT use solvents or petrol based fluids. For stubborn stains, you may use a damp soft cloth with diluted detergent.

Unit and Accessories

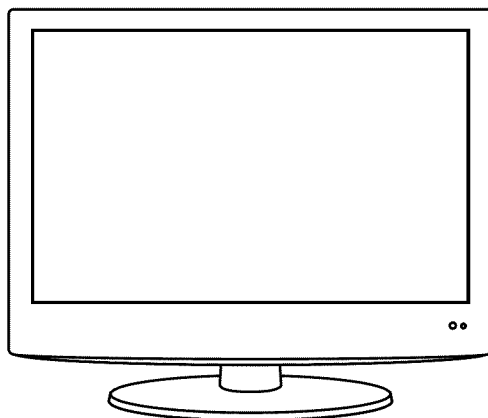

TV set

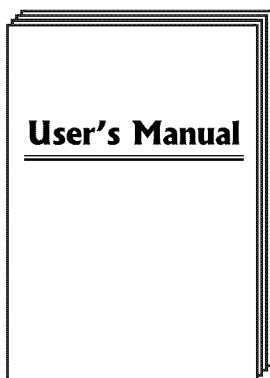

User's manual

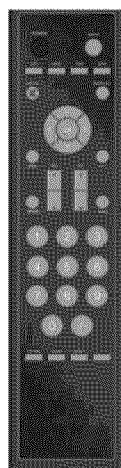

Remote control
Batteries: 2xAA

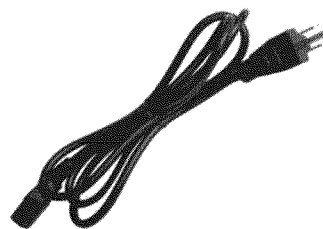

Mains Cable

Product Feature

- Inputs: RF, VIDEO, VGA, YPbPr, HDMI
- Audio Input: AV Audio R/L, PC Audio
- Support TV mode: NTSC-M, ATSC
- Search TV: Auto/Manual
- Auto-shutting down
- Program exchange and edit

Introduction

1. Front View

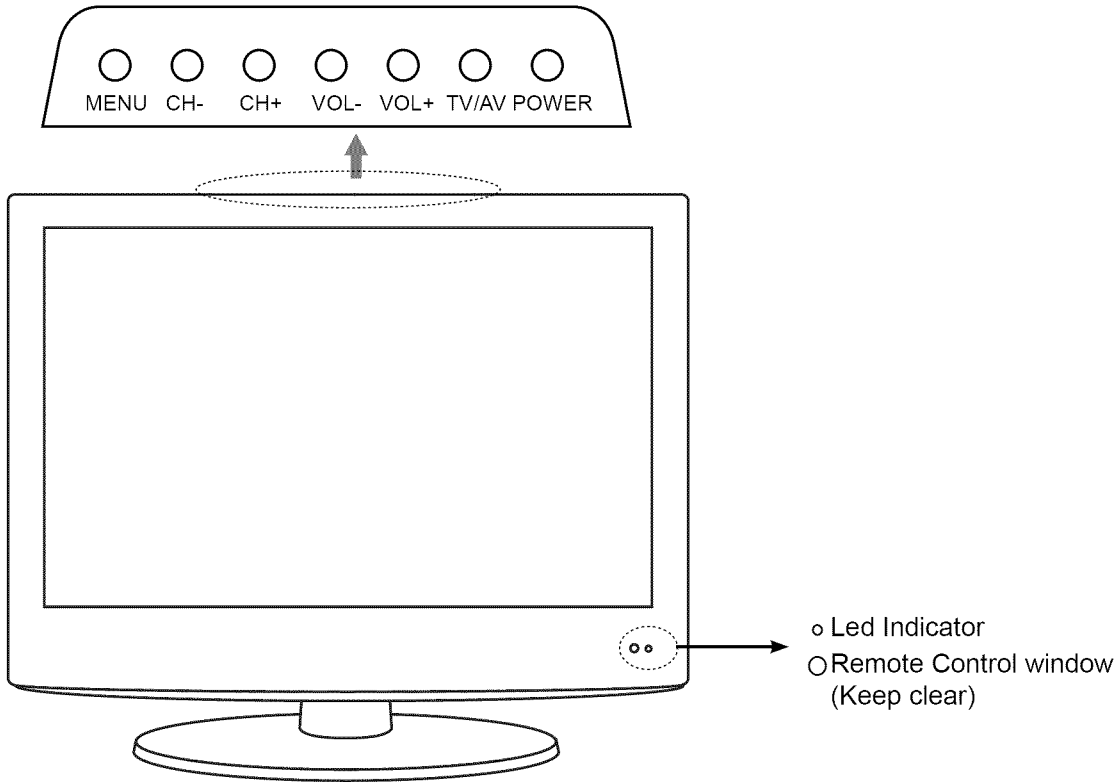

1. (IR) Infrared Receiver: Receives IR signals from the remote control.
(Power on/Standby)LED Indicator: Press **POWER** to turn on and off.

Indicator on(Red)	Standby mode
Indicator on(Green)	Power on mode

The effective receiving range for the signal is 5-8 metres from the front of the remote control window, and 30° to the left or right side and 20° above or below the remote control window.

2. The functions of the buttons:

TV/AV: Press to display the input source menu.
MENU: Press to display the OSD menu, press again to exit the menu.
CH+/-: Press to scan through channels.
VOL+/-: Press to adjust the volume.
POWER: Turn on/standby the TV set.

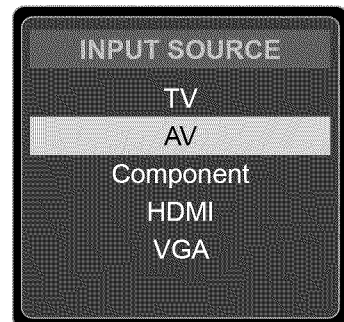



Press **TV/AV** button on the TV set or remote control to display the input source menu, and use **CH+/-** button on the TV set or **^ / v** button on remote control to select the input source, press **OK** button on the remote control to enter.

Note: Before you select the input source, make sure the connections are prepared.

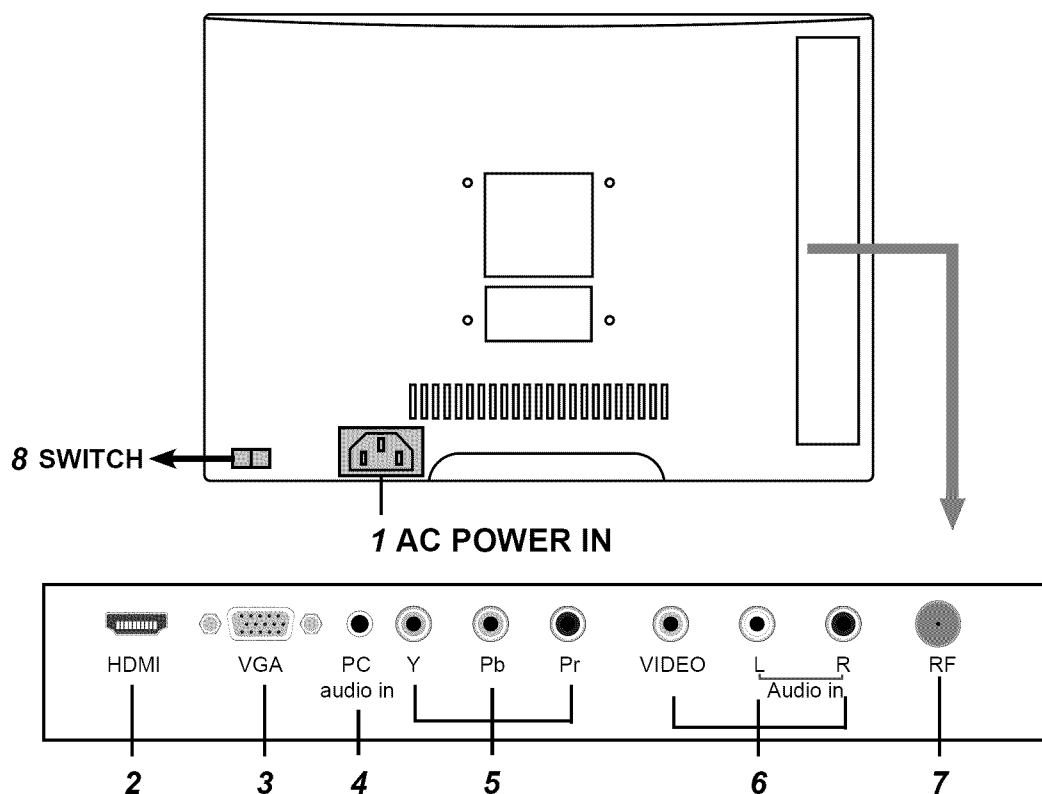
2. Rear View



1. **AC POWER IN:** Connect to an earth 100-240V,50-60Hz AC outlet with the Power Cable.
2. **HDMI:** Connect it to the HDMI of DVD or other equipment.
3. **VGA:** For PC display.Connect it to the D-Sub 15 pins analog output connector of the PC.
4. **PC AUDIO:** Connect it to the audio output terminal of PC.
5. **YPbPr:** Connect them to the YPbPr video output terminal of DVD.(used in YPbPr source)
6. **VIDEO:** Connect it to video output terminal of DVD.
L/R in: Connect them to the audio output terminal of DVD(shared with YPbPr)
7. **RF:** Connect antenna or cable 75 Ohm coaxial to receive TV signal.
8. **SWITCH:** Switch on or off the power suply.

- To turn on the LCD TV
Press  on the back of the LCD TV to  first.
- Be sure to turn off the power and unplug both units from the wall outlet before making any connections.

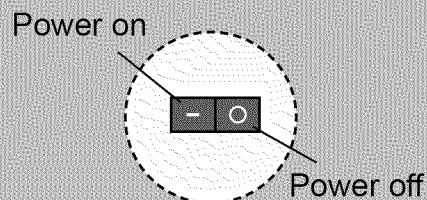

Wall Mounting

The TV is provided with mounting holes for a VESA approved wall mounting bracket(NOT SUPPLIED). Remove the Two Posi screws holding the base to the base bracket and lift the base away (do not remove the base mounting bracket). Mount the VESA bracket using 4 x M4 x10 Iso metric threaded screws (not supplied). Do not use screws longer than 10 mm, damage will occur to the internal parts. Fit the wall bracket securely following the manufacturers instructions.

3. Remote Control

The remote control is using Infra-Red(IR). Point it towards the front of the LCD TV. The remote control may not work correctly if it is operated out of range or out of angle.



POWER(red button): Turn the TV on/standby.
TV/AV: Press to display the input source menu.

CC: Press to display the closed caption.
MTS: Press to select the audio channels.
FAV: Press to add or remove favorite channel.
EPG: Press to enter the EPG menu directly.

MUTE: Press to mute the sound, press again or press VOL+ to unmute.
DISPLAY: Display the information of current mode.
Thumbstick(< > ^ \ v): Allows you to navigate the on-screen menus and adjust the system settings to your preference.
OK: CONFIRM button.
MENU: Press to display the OSD menu.
EXIT: Press to exit the OSD menu.
VOL+/-: Press to adjust the volume.
CH+/-: Press to scan through channels.
RETURN: Return to the previous channel viewed.
TIMER: Shutdown timer.

Number Buttons: Choose channel directly.
Select channel 5, Press button "5";
Select channel 62, Press button "6", then press button "2" in 2 seconds;
Select channel 151, Press button "1", and press button "5" in 2 seconds, and press button "1" in 2 seconds;
Select channel 5-1, Press button "5", and press button "- / - -" in 2 seconds, and press button "1" in 2 seconds;

PICTURE: Press repeatedly to cycle through the available video picture modes.
SOUND: Press to cycle through the different sound settings.
ASPECT: Press to change the screen display mode.

Installing Batteries

1. Open the battery compartment cover on the back of the remote control.
2. Insert two 1.5V AA size batteries observing the polarity markings inside the battery compartment. Don't mix different types or used batteries with new ones.
3. Close the cover.



Batteries shall not be exposed to excessive heat such as sunshine or fire.

- The remote control should be operated within 30 feet(7m) and 30° to the left and right of the IR receive at the front of the LCD TV.
- Used batteries should be disposed properly.

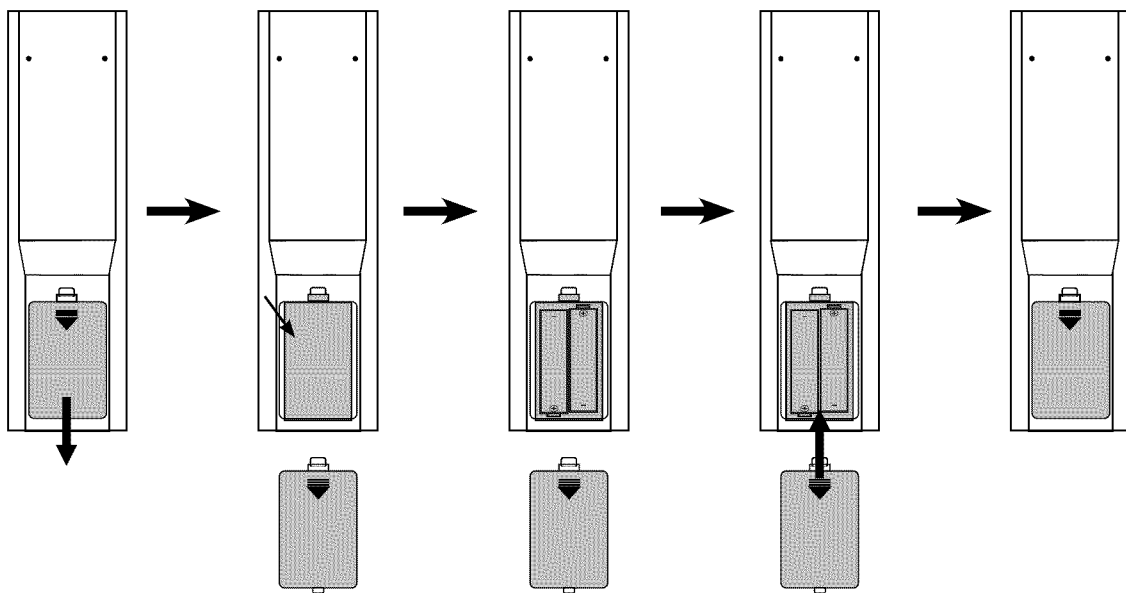

Connection

Power Cord Connection

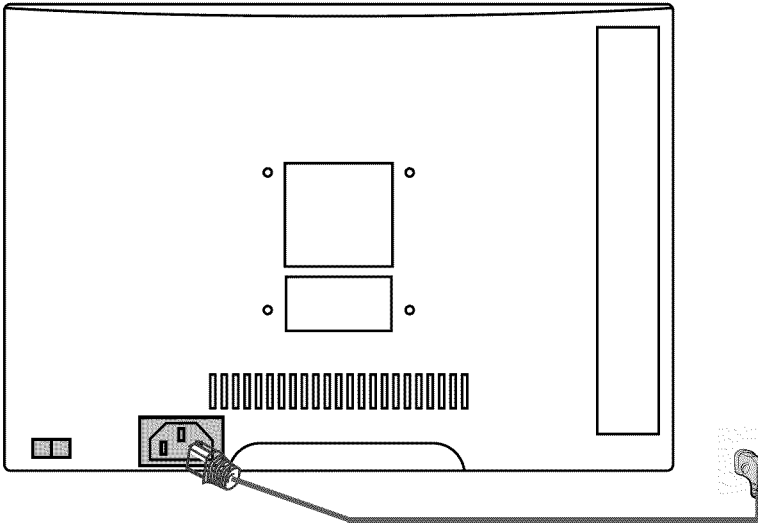

- Connect the power cord correctly as shown with the mains cable, and turn the switch (Page 6) on.
- When you connect the power, the TV set comes into standby mode and the LED indicator (Page 5) lights red.
- You could bring the TV out of standby mode by press the **POWER** button on TV set (page 5) or remote control(page 7), and the LED indicator lights green.

Antenna(RF) Connection

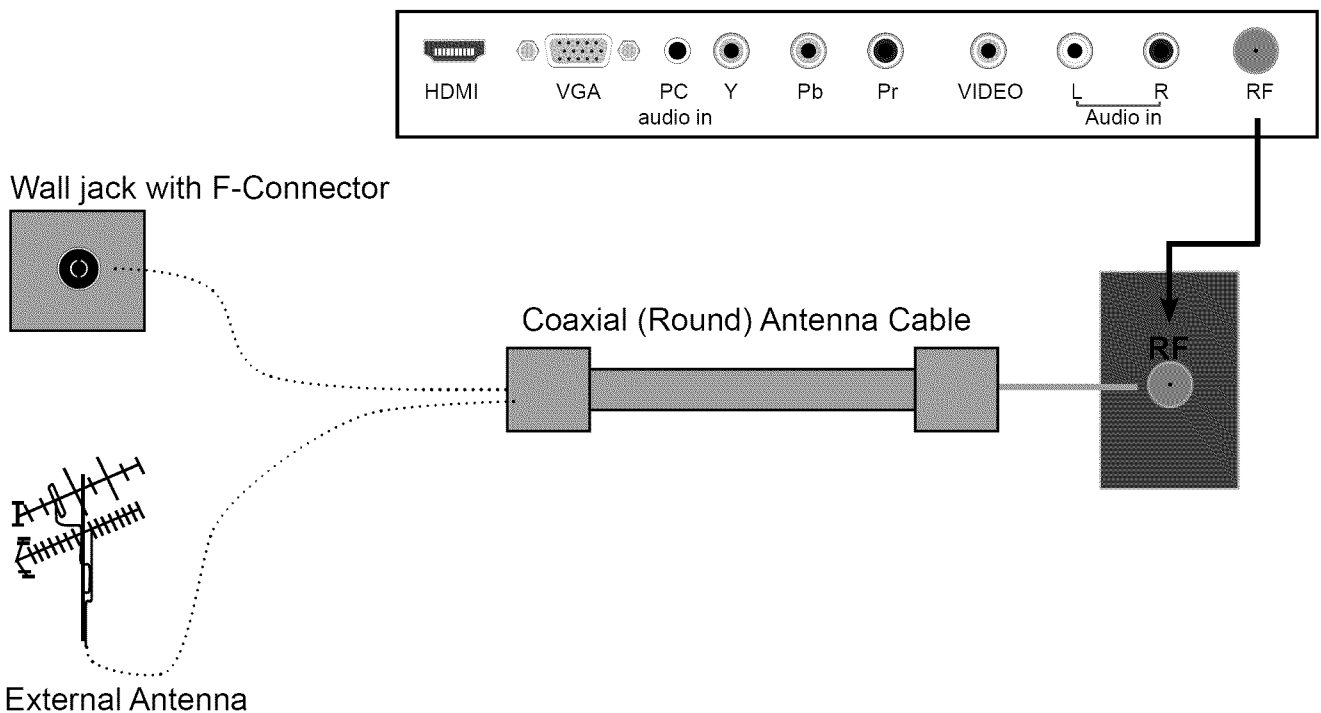

Press **TV/AV** button on the remote control to display the input source menu, press **^ / v** button to select **TV**, then press **OK** button to confirm, and you will receive the signal.

Connection

AV Input Connection

Note: All cables shown are not included with the TV.

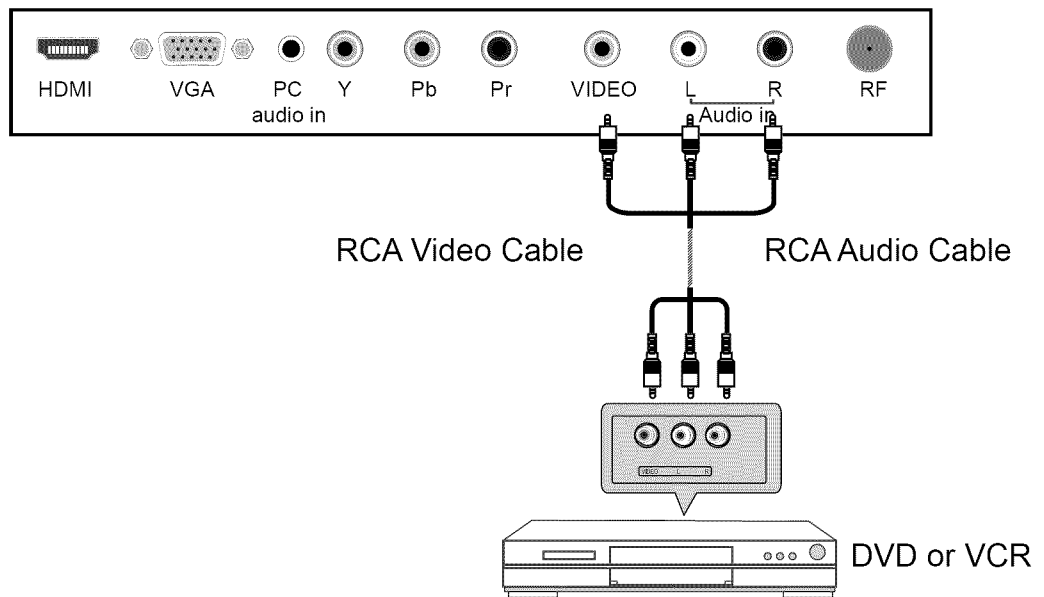

- Connect the VIDEO and AUDIO output jacks on the DVD or VCR to the AV IN jacks on the TV set with a RCA cable.
- Match the jacks colors: **Video=yellow, Audio left=White, Audio right=red.**
- Turn on the DVD/VCR, and select "AV" in the input source menu.

YPbPr Connection

Note: All cables shown are not included with the TV.

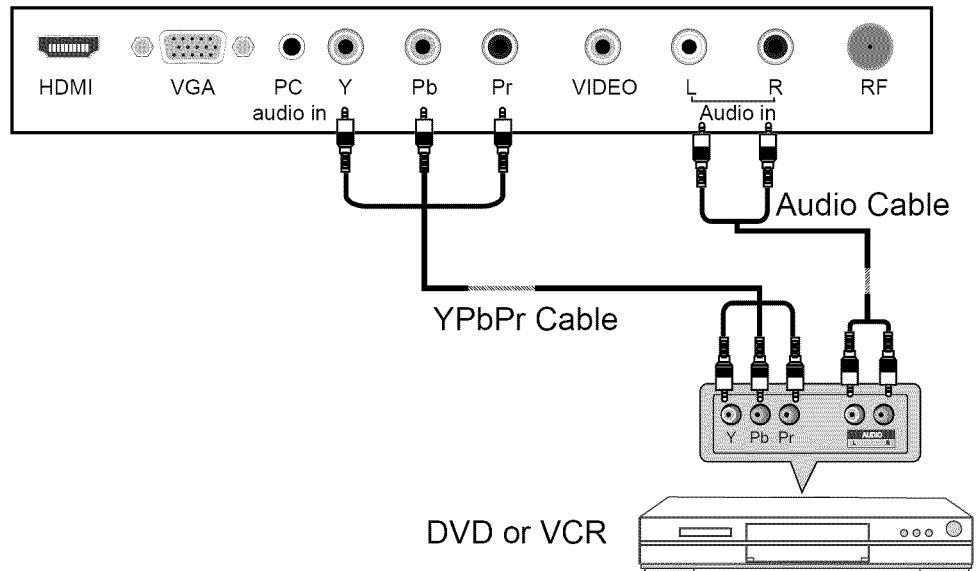

- Connect the YPbPr output jacks on the DVD or VCR to the YPbPr input jacks on the TV set with a YPbPr cable. The picture quality is improved compared to a regular VCR to the video input.
- Match the jacks colors: **Y=Green, Pb=Blue, Pr=red.**
- Connect the audio output jacks on the DVD or VCR to the audio input jacks on the set with an audio cable.
- Turn on the DVD/VCR, and select "YPbPr" in the input source menu.

Connection

HDMI Connection

Note: All cables shown are not included with the TV.

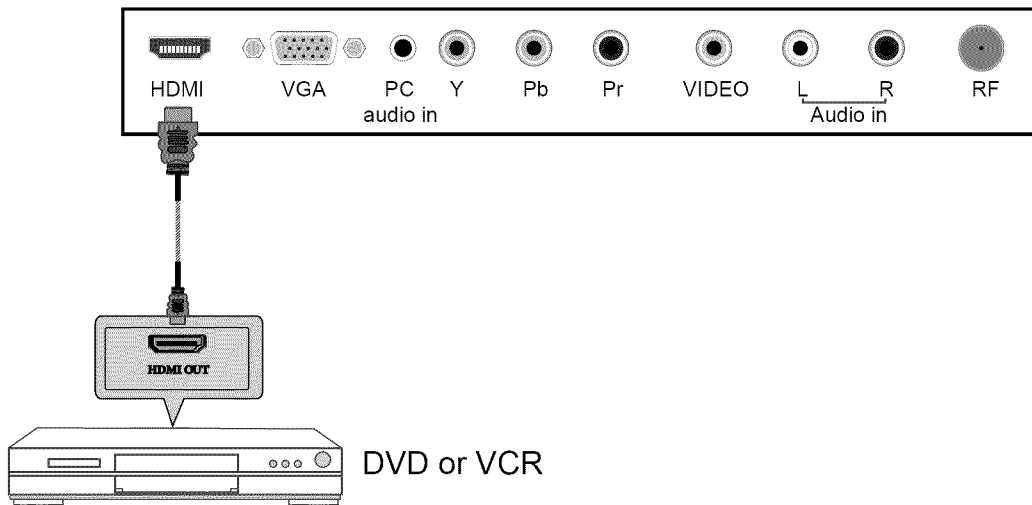

- Connect the HDMI jack on the DVD to the HDMI jack on the TV set with a HDMI cable.
- Turn on the DVD, and select "HDMI" in the input source menu.
- HDMI(High Definition Multimedia Interface) is the first all digital consumer electronics A/V interface that supports uncompressed standard. One jack supports both video and audio information.

PC Connection

Note: All cables shown are not included with the TV.

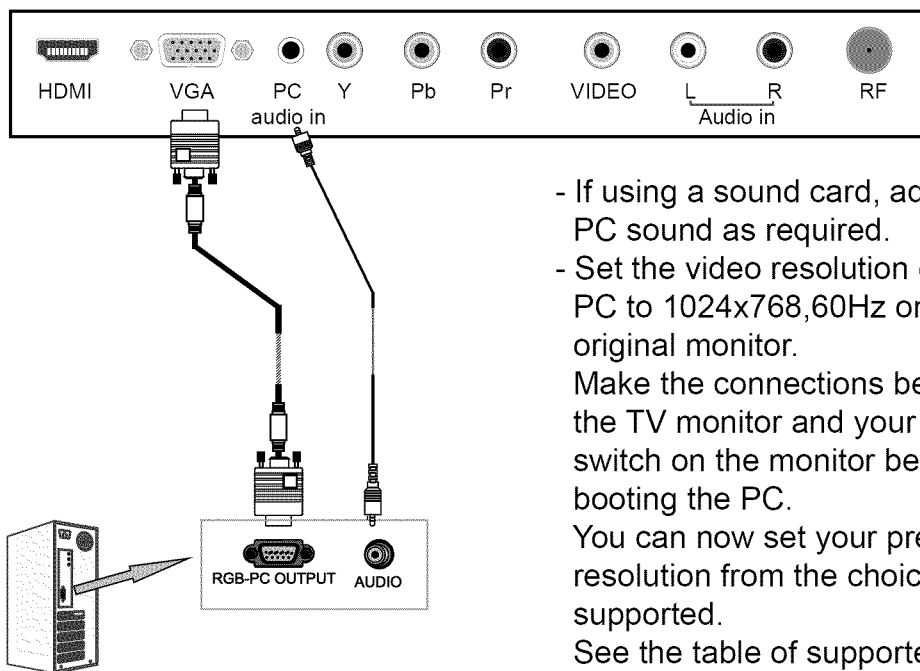

- If using a sound card, adjust the PC sound as required.
 - Set the video resolution of your PC to 1024x768,60Hz on its original monitor.
- Make the connections between the TV monitor and your PC, switch on the monitor before booting the PC. You can now set your preferred resolution from the choice supported. See the table of supported resolutions on the right.

Supported PC resolutions

640 x 480, 60 Hz
640 x 480, 72 Hz
640 x 480, 75 Hz

800 x 600, 75 Hz
800 x 600, 60 Hz
800 x 600, 72 Hz

1024 x 768, 60 Hz
1024 x 768, 70 Hz
1024 x 768, 75 Hz

1280 x 768, 60 Hz

1360 x 768, 60 Hz



- Connect the RGB jack on the PC to the VGA jack on the TV set with a VGA cable.
- Connect the audio output jack on the PC to the PC IN jack on the TV set with a stereo audio cable.
- Turn on the PC, and select "VGA" in the input source menu.

Basic Operation

Power on/off

1. Connect to the power with a power code, and turn on the switch(page9).
- 2.-To turn on the TV
Press **POWER** button on the TV or remote control.
- To turn off the TV
Press **POWER** button on the TV or remote control.

Input Source select

Press **TV/AV** button on the TV set or remote control to display the input source menu, and use **CH+/-** button on the TV set or **^ / v** button on remote control to select the input source, press **OK** button on the remote control to enter.

Note: Before you select the input source, make sure the connections are prepared.

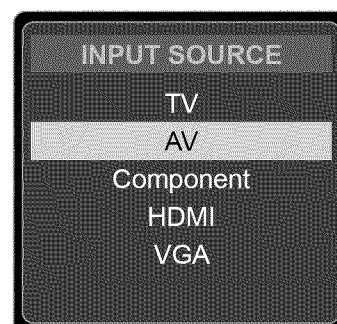

Basic buttons on the remote control

POWER(red button): Turn the TV on/standby.

TV/AV: Press to display the input source menu.

MUTE: Press to mute the sound, press again or press VOL+ to unmute.

DISPLAY: Display the information of current mode.

Thumbstick(< > ^ v): Allows you to navigate the on-screen menus and adjust the system settings to your preference.

OK: CONFIRM button.

MENU: Press to display the OSD menu.

EXIT: Press to exit the OSD menu.

VOL+/-: Press to adjust the volume.

CH+/-: Press to scan through channels.

RETURN: Return to the previous channel viewed.

TIMER: Shutdown timer.

Number Buttons: Choose channel directly.

Select channel 5, Press button "5";

Select channel 62, Press button "6", then press button "2" in 2 seconds;

Select channel 151, Press button "1", and press button "5" in 2 seconds, and press button "1" in 2 seconds;

Select channel 5-1, Press button "5", and press button "- / - -" in 2 seconds, and press button "1" in 2 seconds;

PICTURE: Press repeatedly to cycle through the available video picture modes.

SOUND: Press to cycle through the different sound settings.

ASPECT: Press to change the screen display mode.

Basic OSD Menu operation

Press **MENU** button to display the OSD menu as below:

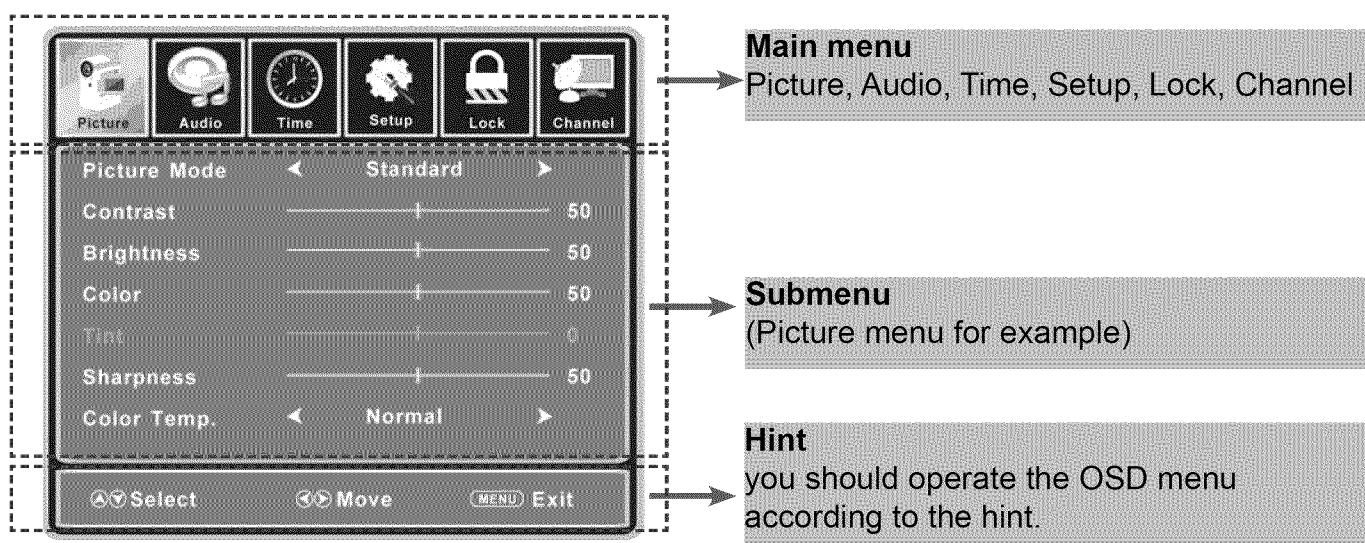

Use < / > button to select the main menu, and press √ button to enter the submenu.

In the submenu, use ^ / v button to select the function item, and you could:

adjust ("Contrast" item in **Picture** menu for example) with < / > button;

select ("Picture Mode" item in **Picture** menu for example) with < / > button;

enter the submenu ("Close Caption" item in **Setup** menu for example) with > button.

* (Press MENU button to return to the upper menu.)

* (Press EXIT button to exit the menu display.)

Note1: Only when you input the suitable signal, the relevant items can be activated

Note2: Please operating the OSD menu according to hint on the bottom of the banner.

OSD Menu

1. Picture menu

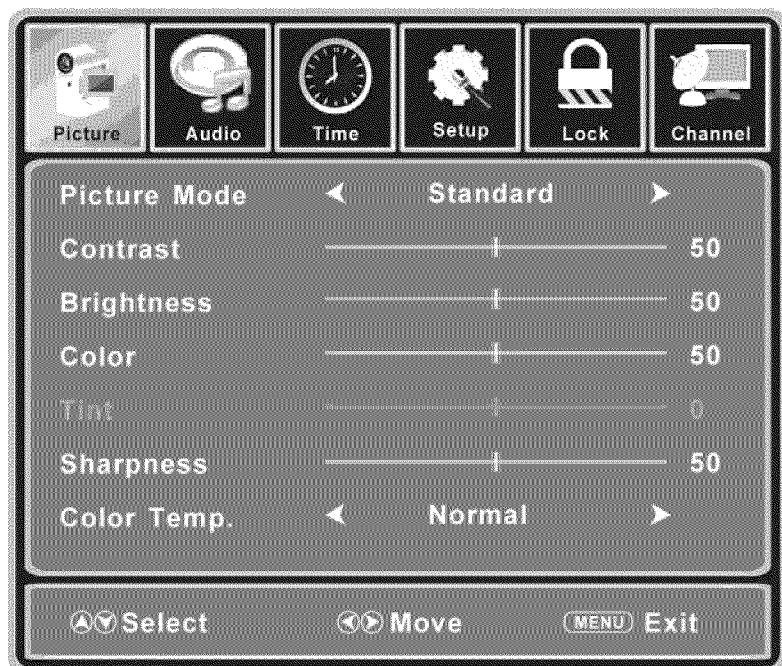

Description

Picture mode: Select between Standard, Dynamic, Mild, Sports and User.

You may select the picture mode directly by pressing the **PICTURE** button on the remote control.

Contrast: Control the difference between the bright and dark regions of the screen picture.

Brightness: Adjust brightness of the picture.

Color: Adjust color of the picture.

Tint: Control the fresh tones to make them appear natural.

Sharpness: Set the amount of fine detail in the picture.

Color Temp.: select between Normal, Cool and Warm.

2. Audio menu

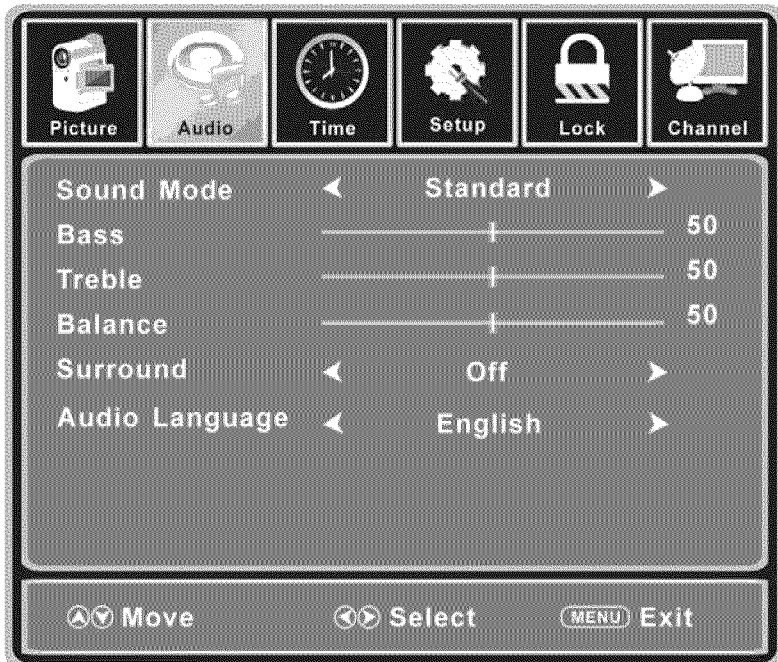

Description

Sound Mode: Select your desired picture mode as follow: Flat, Music, Movie, Sports and User
You may select the sound mode directly by pressing the **SOUND** button on the remote control.

Bass: Low frequencies intensity.

Treble: High frequencies intensity.

Balance: Left and right stereo audio channels balance.

Surround: Activate or deactivate the Surround function.

Audio Language: Select audio language.

3. Time menu



Description

Sleep timer: You may set the automatic shutdown timer choosing from 5 to 240 minutes, or deactivate this function.

Time zone: Select between Pacific, Alaska, Hawaii, Eastern, Central and Mountain.

Daylight Saving Time: Select between On and Off.

Clock: Modify date and time.

4. Setup menu

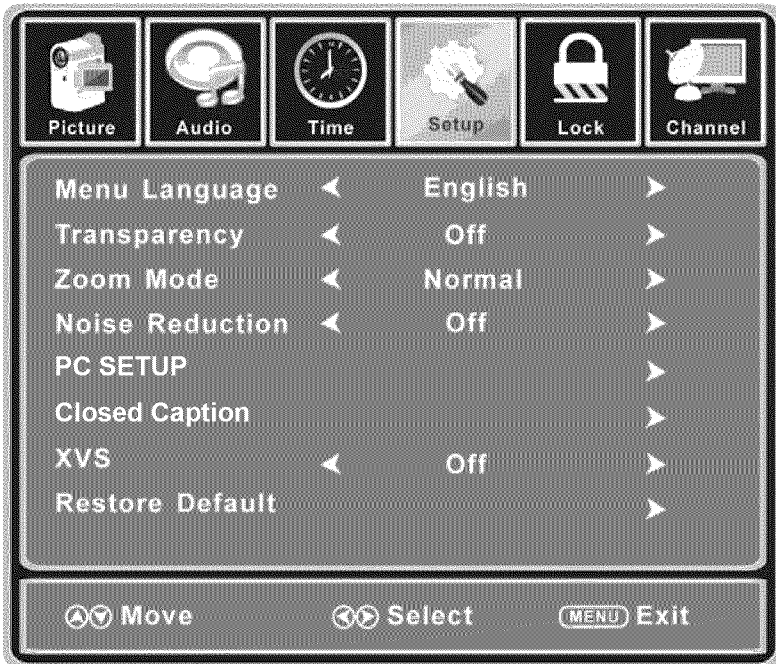

Description

Menu Language: Select OSD menu language.

Transparency: Turn on or off the transparency menu function.

Zoom Mode: Select the zoom mode between 16:9, 16:9 zoom, 4:3, 4:3 zoom.

Noise reduction: Select the noise reduction mode between Strong, Off, Weak and Middle.

PC SETUP: If the video input signal comes from your PC, you may adjust the V-Position, H-Position, Frequency, Phase or even perform an Auto adjustment.

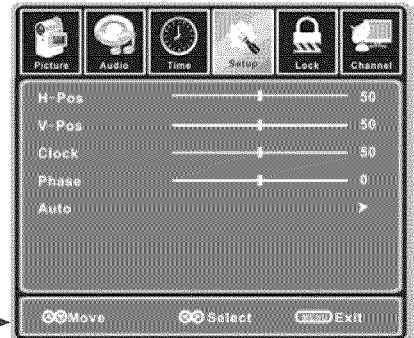

Closed Caption:

CC Mode: Allow you to select the CC Mode among: On, Off and CC on Mute.

Basic Selection: Allow you to select the basic selection among: CC1, CC2, CC3, CC4, Text1, Text2, Text3 and Text4.

Advanced Selection: Allow you to select the advanced selection among: Service1, Service2, Service3, Service4, Service 5 and Service 6.

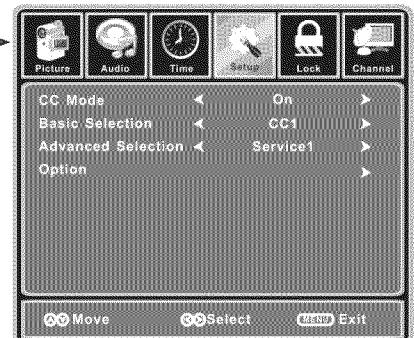

Option: Use thumbstick buttons to operating in option menu as your desire.

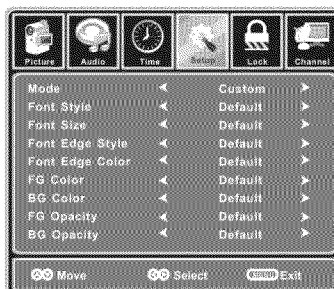

XVS: Activate / deactivate the automatic dynamic brightness function.

Restore Default: Restore all settings in SETUP menu to factory settings.

5. Lock menu

You must enter the password to gain access to the Lock menu. The default password is 0000. You may modify the following options:

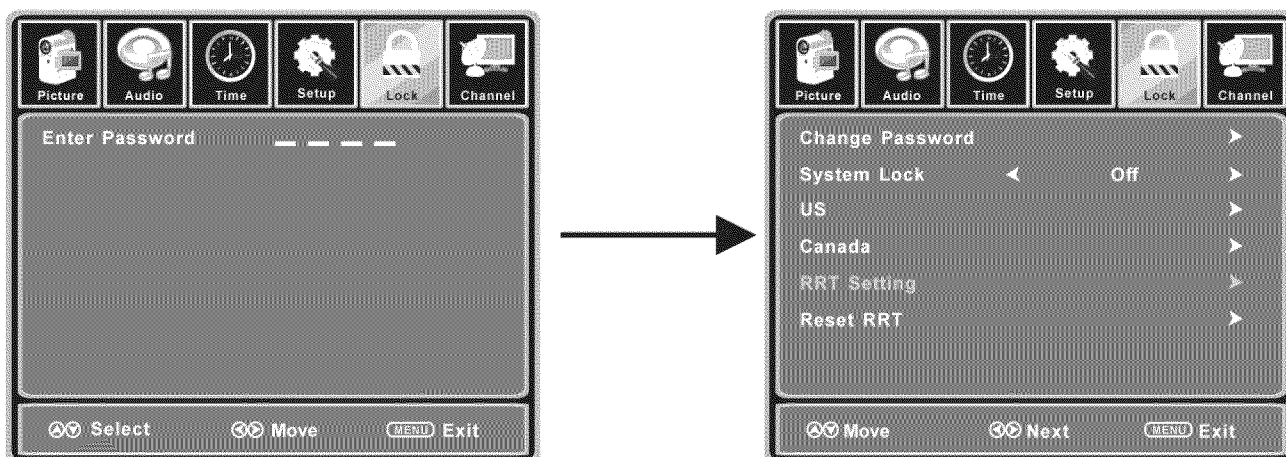

Description

Change password: Change the password, you must enter the new password twice to confirm it. Note: Do not forget the password.

Lock: Allow you to turn on or off the system lock. If deactivated, the functions described below don't work.

This option menu allows you to lock any TV channel or adjust the Movie rating filter.

US: →

TV: Use \wedge / \vee buttons to select the desired rating and press \gt button to block or unblock rating.

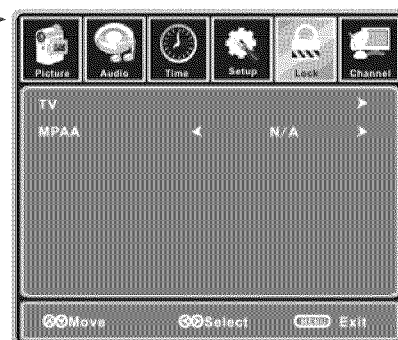
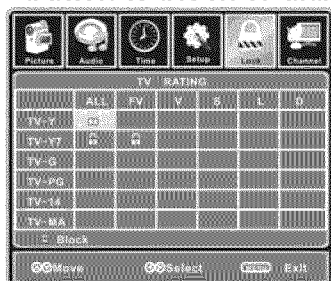

MPAA: The Movie rating (MPAA) is used for original movies rated by the Motion Picture Association of America (MPAA) as broadcasted on cable TV and not edited for television.

Use \wedge / \vee button to select N/A, G, PG, PG-13, R, NC-17 or X.

RATING	DESCRIPTION
G	General Audiences. Movie is appropriate for all ages.
PG	Parental Guidance Suggested. May contain material not suited for younger viewers.
PG-13	Contains content that may not be appropriate for viewers under the age of 13.
R	Restricted. Contains adult content, no one under 17 admitted without parent.
NC-17	No one 17 and under admitted.
X	Adults only.

Canada: →

Canada English: Select among: E, C, C8+, G, PG, 14+ and 18+.

Canada French: Select among: E, G, 8ans+, 13ans+, 16ans+ and 18ans+.

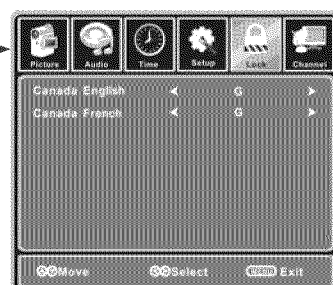

Reset RRT: Allow you to reset the RRT setting.

6. Channel menu

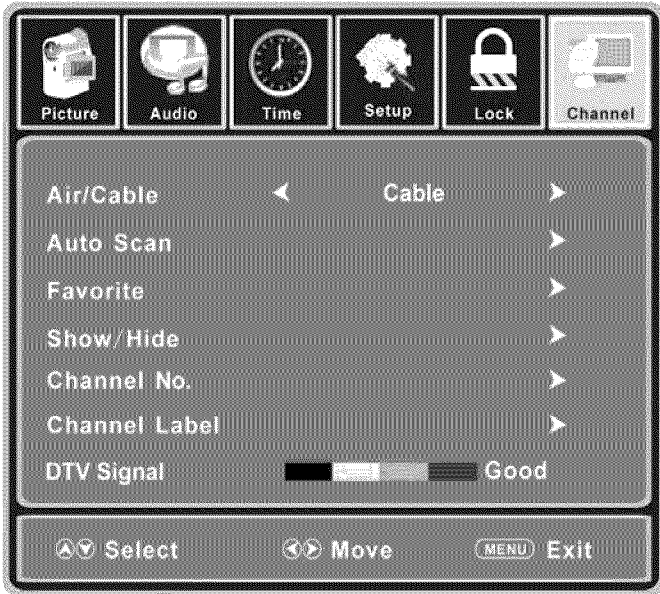

COLOR TV BROADCASTING SYSTEM

Country	Color System	Sound System
AZORES(PORTUGAL)	PAL	B/G
BALKANS(KOSOVO, BOSNIA)	PAL	B/G
BELGIUM/GERMANY/ITALY	PAL	B/G
IRAQ	SECAM	B
AFGHANISTAN	PAL	B
NETHERLANDS/NORWAY	PAL	B/G
SAUDI ARABIA	SECAM	B
	PAL	B
KUWAIT/TURKEY/JORDAN	PAL	B/G
UNITED KINGDOM	PAL	I
CZECH/HUNGARY/POLAND	PAL	D/K
RUSSIA	SECAM	D/K
U.S.A./JAPAN/KOREA/GUAM	NTSC	M

Description

Air/Cable: Allow you to select antenna between Air and Cable.

If you select "Cable", the following items(Favorite, Show/Hide, Channel NO, Channel Label and DTV Signal) are unable to use.

Auto Scan: Enter the Auto Scan menu to start auto scan.



- ★ If you select "Cable" as input signal in Antenna item, allows you to select Cable System among: Auto, STD, IRC and HRC. Use ∇ button to highlight the "Start to Scan", then press \gt button to search the channels automatically. The receivable channels will be stored automatically. When searching channels, press **MENU** to stop.

- ★ If you select "Air" as input signal in Antenna item, you can press \gt button to search the channels automatically. The receivable channels will be stored automatically. When searching channels, press **MENU** to stop. NOTE: It will take a while to auto scan in NTSC or ATSC mode, please wait patiently.

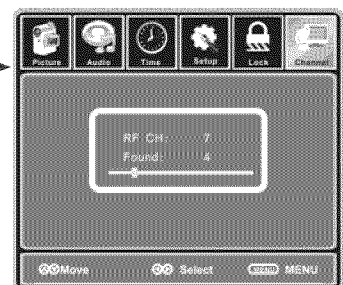

Favorite: Allow you to add these channels which you desired as the favorite channels.

Use \wedge / ∇ button to highlight the desired item, then press **OK** button to add or remove the highlighted channel as favorite.

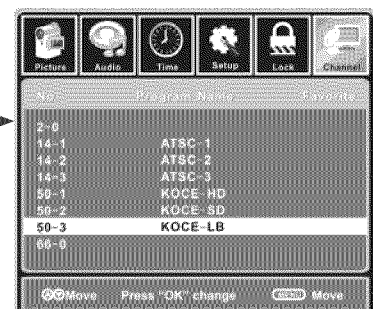

OSD Menu

Show/Hide: Allow you to show or hide the channels.

Use \wedge / \vee button to highlight the desired item, then press **OK** button to show or hide the highlighted channel.

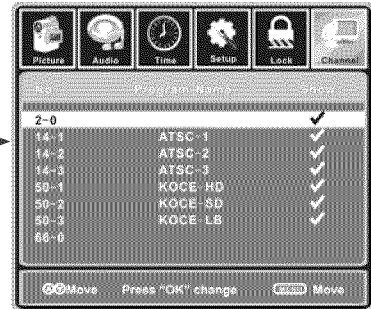

Channel No.: Show and select the channel.

Channel Label: Allow you to setup a label for the channel.

Press $<$ / $>$ button to select the position of the table, and press \wedge / \vee button to select the words.

DTV Signal: Show the quality of digital signal: good, Normal, Bad.

Simple Troubleshooting

If the display fails or performance dramatically deteriorates check the Display in accordance with the following instructions. Remember to check the peripherals to pinpoint the source of the failure.

If the display still fails to perform as expected, connect your helpline for assistance.

No power

- Check all connections to the TV.
- Press either the power button or the Standby button on the Remote control.

No picture or sound

- Ensure that the TV is plugged in and the power is on.
- Ensure that the aerial is connected.
- Try a different programme.

Poor picture quality

- Check the aerial connections.
- Check that the channel is tuned in properly.
- Adjust the picture settings: brightness, colour, sharpness, contrast, hue.
- Make sure that the TV is not located close to electrical appliances that may emit radio frequency interference.

No colour

- Adjust the colour setting.
- Check that the programme is broadcast in colour.
- Check that the channel is tuned properly.

TV does not respond to remote control

- Check that there are no obstructions between the remote control and the unit.
- Check that the remote control is within range of the unit.
- Check that the batteries in the remote control are not weak or exhausted.

This LCD TV is for household use and registered as harmless on electromagnetic waves. Therefore, you can use it in every location as well as residential areas.

Technical Specifications

LCD Panel	Panel Size	21.6 inch(diagonal)
	Brightness	300 cd/m ²
	Contrast	1000:1
	Resolution	1920x1080
Input Connector	Video	1
	Audio(L/R)	1
	VGA	1
	PC Audio	1
	HDMI	1
	YPbPr	1
	RF	1
Power Source	AC100-240V 50/60Hz	
Power Consumption	60W	

The cabinet design and electronics specifications will be modified without prior notice for improving the performance.

VIORE™ LIMITED WARRANTY

FLAT PANEL TELEVISION

This **VIORE** brand Product, as supplied and distributed by **VIORE** and delivered new in the original carton to the original purchaser is warranted by **VIORE** against manufacturing defects in materials and workmanship for a limited warranty period of one (1) year on parts and labor. However, there will be only a 90 day parts and labor limited warranty for commercial use.

This Limited Warranty does not apply to store display products and product sold as a "marked down" special, in "as is" condition, "open box", products missing accessories, no fault found or damaged at time of delivery to Viore.

Proof of purchase within one year from date of purchase in the form of a Bill of Sale, Receipt or Receipted Invoice is evidence the Product is within the limited warranty period. The Bill of Sale, Receipt or Receipted Invoice must be presented as a pre-condition to obtaining the limited warranty service.

This limited warranty begins on the original date of purchase, and is valid only on Products purchased through **VIORE** authorized dealers and used in the United States by the original purchaser. To receive warranty service, the purchaser must contact **VIORE** for problem determination and service procedures. Warranty service may only be performed by a duly authorized **VIORE** service center. The original dated bill of sale, receipt or receipted invoice must be presented upon request as proof of purchase to **VIORE** or **VIORE's** authorized service center.

VIORE will repair or if repairs cannot be made, **VIORE** will replace this Product at no charge if the Product is defective as specified in this limited warranty during the limited warranty period. **VIORE** may use new, or remanufactured parts or products to repair or replace the Product at its sole discretion. All replaced parts and Products become the property of **VIORE** and must be returned to **VIORE**. Replacement parts and Products assume the remaining original limited warranty, or ninety (90) days, whichever is longer.

Product freight needs to be prepaid by original purchaser and shipped in either its original packaging or packaging affording an equal degree of protection. **VIORE** shall not be responsible for or obligated to replace damaged goods. If you reside in California and you cannot transport the television due to the size, weight, and method of attachment, **VIORE** will provide transportation for the television to the repair facility. If you reside in a state other than California, you are responsible for the costs of transporting the television to a repair facility.

If the product is received damaged by **VIORE**, it is the responsibility of the consumer to file a claim against the carrier. **VIORE** will only store the damaged product for 30 days and reserves the right, in its sole discretion, to dispose of the damaged product or ship it back to the consumer at consumer's expense after 30 days.

This limited warranty covers manufacturing defects in materials and workmanship encountered in normal, and except to the extent otherwise expressly provided for in this statement, noncommercial use of this product, and shall not apply to the following, including, but not limited to: damage which occurs in shipment; delivery and installation; applications and uses for which this product was not intended; altered product or serial numbers; cosmetic damage or exterior finish; accidents, abuse, neglect, fire, water, lightning or other acts of nature; use of products, equipment, systems, utilities, services, parts, supplies, accessories, applications, installations, repairs, external wiring or connectors not supplied or authorized by **VIORE** which damage this product or result in service problems; incorrect electrical line voltage, fluctuations and surges; customer adjustments and failure to follow operating instructions, cleaning, maintenance and environmental instructions that are covered and prescribed in the instruction book; reception problems and distortion related to noise, echo, interference or other signal transmission and delivery problems; burned-in images. **VIORE** does not warrant uninterrupted or error-free operation of the product.

THERE ARE NO EXPRESS WARRANTIES OTHER THAN THOSE LISTED AND DESCRIBED ABOVE, AND NO WARRANTIES WHETHER EXPRESS OR IMPLIED, INCLUDING, BUT NOT LIMITED TO, ANY IMPLIED WARRANTIES OF MERCHANTABILITY OR FITNESS FOR A PARTICULAR PURPOSE, SHALL APPLY AFTER THE EXPRESS WARRANTY PERIODS STATED ABOVE, AND NO OTHER EXPRESS WARRANTY OR GUARANTY GIVEN BY ANY PERSON, FIRM OR CORPORATION WITH RESPECT TO THIS PRODUCT SHALL BE BINDING ON VIORE. REPAIR OR REPLACEMENT AS PROVIDED UNDER THIS LIMITED WARRANTY IS THE EXCLUSIVE REMEDY OF THE CONSUMER. VIORE SHALL NOT BE LIABLE FOR ANY INCIDENTAL, OR CONSEQUENTIAL DAMAGES FOR BREACH OF ANY EXPRESS OR IMPLIED WARRANTY ON THIS PRODUCT; EXCEPT TO THE EXTENT PROHIBITED BY APPLICABLE LAW, ANY IMPLIED WARRANTY OF MERCHANTABILITY OR FITNESS FOR A PARTICULAR PURPOSE ON THIS PRODUCT IS LIMITED IN DURATION TO THE DURATION OF THIS LIMITED WARRANTY. THIS LIMITED WARRANTY SHALL NOT EXTEND TO ANYONE OTHER THAN THE ORIGINAL PURCHASER OF THIS PRODUCT, IS NONTRANSFERABLE AND STATES YOUR EXCLUSIVE REMEDY.

Some states do not allow limitations on how long an implied warranty lasts, or the exclusion or limitation of incidental or consequential damages, so the above limitations or exclusions may not apply to you. This warranty gives you specific legal rights, and you may also have other rights which vary from state to state. Any provision contained herein which is found contrary to state or local laws shall be deemed null and void and the remaining provisions shall continue in full force and effect.

To obtain warranty service, please contact **VIORE** at:

Phone: 877-777-1428
www.viore.com