

VIORE™ TECHNOLOGY & INNOVATION

OPERATING INSTRUCTIONS

47" 1080p LCD Television *LC47VXF60PB*



AIR (TV)/CABLE MODE SELECTION

The Air/CABLE menu option is set to the "CABLE" (Cable Television) mode at the factory. If you want to use an antenna for the built-in TV tuner, this menu option must be set to the "Air" mode. Please refer to page 25 of the owner's manual for the details of this menu.

FOR QUESTIONS OR TECHNICAL SUPPORT

Please call: 1-877-777-1428

Please do not return this TV to the store.

CONTENTS

Safety Precautions

- Caution 1
- Safety Information 2

User Guidance Information

- Names of each part(Front View) / Accessories 3
- Names of each part(Back View) 4
- Mounting on a Desktop / Installation Precautions 5
- Installing an Antenna 6
- Remote control 7~8
- Precautions / How to use remote control 9

Connection

- VCR Connections / Watching Video Tape 10
- Satellite/Cable TV Set-Top Box Connections / Watching Cable TV 11
- DVD Connections / Playing the DVD 12
- PC Connections / How to use as PC 13
- Audio Amplifier and Monitor Connections / Digital Amplifier Connection 14

Basic Use

- Powering the LCD TV / Selecting input source 15

Application

- Operating the Menu 16
- Customizing the PICTURE Settings 17
- Customizing the SOUND Settings 18
- Customizing the TIMER Settings 19
- Customizing the SETUP Settings 20~21
- Customizing the LOCK Settings 22~24
- Customizing the CHANNEL Settings 25~26
- Support mode 27

Maintenance and Service

- Trouble shooting 28
- Specifications 29

Caution



The lightning flash with arrowhead symbol, within an equilateral triangle is intended to alert the user to the presence of un-insulated "dangerous voltage" within the products enclosure that may be of sufficient magnitude to constitute a risk of electric shock to the persons.



The exclamation point within an equilateral triangle is intend to alert the user to the presence of important operating and maintenance (servicing) instructions in the literature accompanying the appliance.



Correct disposal of this Product

Waste Electrical & Electronic Equipment (WEEE)

Your product is designed and manufactured with high quality materials and components which can be recycled and reused.

This symbol means that electrical and electronic equipment, at their end-of-life, should be disposed of separately from your household waste.

Please dispose of this equipment at your local community waste collection/recycling centre.

In the European Union there are separate collection systems for used electrical and electronic products. Please help us to conserve the environment we live in!

Safety Information

To ensure reliable and safe operation of this equipment, please read carefully all the instructions in this user guide, especially the safety information below.

Electrical safety

- The TV set should only be connected to a mains supply which matches that stated on the label.
- To prevent overload, don't share the same mains supply socket with too many other items of equipment.
- Do not place any connecting wires where: they may be stepped on or tripped over.
- Do not place heavy items on them, which may damage the leads.
- Hold the main plug, not the wires, when removing from a socket.
- During a thunderstorm or while leaving the TV for long periods, set the switch off.
- Do not allow water or moisture to enter the TV or mains adaptor. Do NOT use in wet or moist areas, such as Bathrooms, steamy kitchens or near swimming pools.
- Pull the plug out immediately, and seek professional help if: the mains plug or cable is damaged, liquid is spilt onto the set, or if it is accidentally exposed to water or moisture, anything accidentally penetrates the ventilation slots, the set doesn't work normally.
- Do not remove the safety covers. There are no user serviceable parts inside. You may invalidate the warranty. This apparatus must only be serviced by qualified personnel.
- To avoid battery leakage, remove exhausted batteries from the remote control, or when not using for a long period.
- Do not break open or throw exhausted batteries on a fire.

Physical safety

- Do not block ventilation slots in the back cover. You may place the TV in a cabinet, but ensure at least 5cm (2") clearance all around.
- Do not tap or shake the TV screen, or you may damage the internal circuits. Take good care of the remote control.
- To clean the TV use a soft dry cloth. Do not use solvents or petrol based fluids.
- Do not install near any heat sources such as radiators, heat registers stoves or other apparatus (including amplifiers) that produce heat.
- Do not defeat the safety purpose of the polarized or grounding-type plug. A polarized plug has two blades with one wider than the other. A grounding type plug has two blades and a third grounding prong, the wide blade or the third prong is provided for your safety. If the provided plug does not fit into your outlet, consult an electrician for replacement of the obsolete outlet.
- Protect the power cord from being walked on or pinched particularly at plugs.
- Use only attachments/accessories specified by the manufacturer.
- Unplug this apparatus during lightning storms or when unused for long periods of time.
- Refer all servicing to qualified service personnel. Servicing is required when the apparatus has been damaged in any way, such as power-supply cord or plug is damaged, liquid has been spilled or objects have fallen into the apparatus, has been exposed to rain or moisture, does not operate normally or has been dropped.
- Please always connect an apparatus with Class I structure to a main socket with protective earthing connection.
- Please make sure both main plug and appliance coupler work properly.

Names of each part

Front View

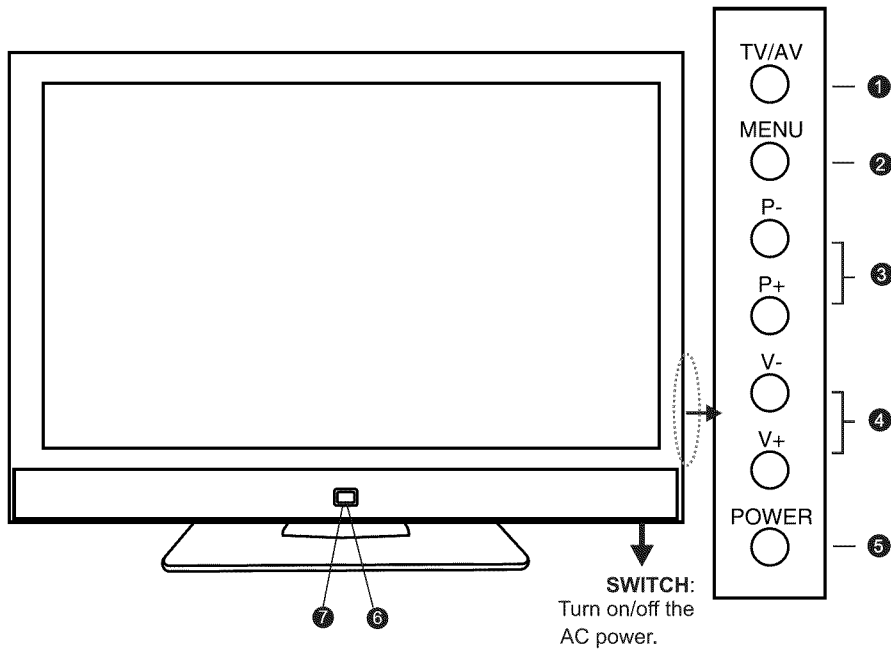

- ① TV/AV button - Input Source Select Button
- ② MENU button - OSD Menu Display Button
- ③ P+/- button - Channel/Program +,- Button
- ④ V+/- button - Volume +,- Button
- ⑤ POWER button
- ⑥ LED Indicator
- ⑦ Remote Control Window

Accessories

- The configuration of the components may look different from the following illustration.

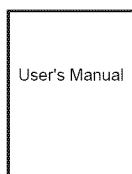

User's Guide



Power Cord



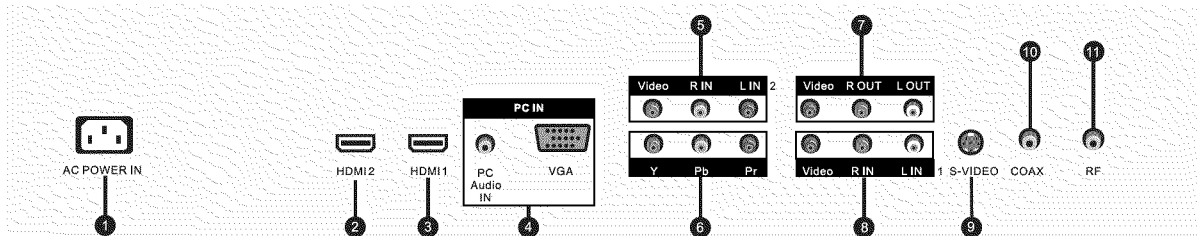

Remote Control

Names of each part



- | | | |
|-------------------------------|-------------------------------|-------------------------------|
| ① AC input jack | ⑥ Y,Pb,Pr jack(component) | ⑩ COAX/AL (Digital Audio out) |
| ② HDMI2 jack | ⑦ AV OUT VIDEO and AUDIO(R/L) | ⑪ RF |
| ③ HDMI1 jack | ⑧ AV1 IN VIDEO and AUDIO(R/L) | |
| ④ PC and AUDIO jack | ⑨ S-VIDEO | |
| ⑤ AV2 IN VIDEO and AUDIO(R/L) | | |

- To turn on the LCD TV

Press  on the bottom of the LCD TV to  first.

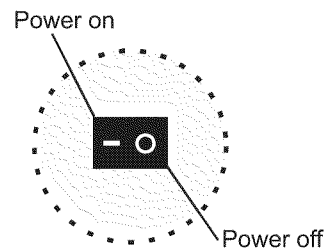

- Be sure to turn off the power and unplug both units from the wall outlet before making any connections.

Mounting on a Desktop

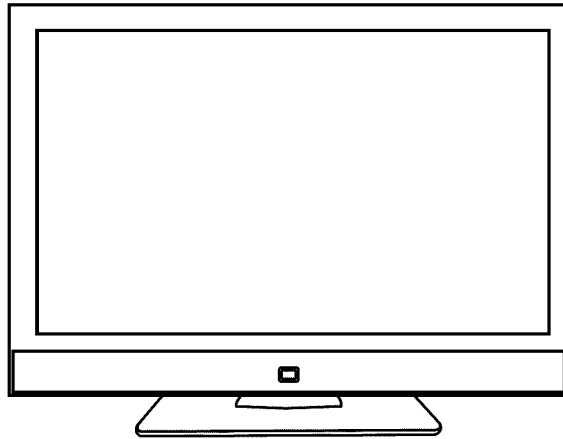

- Your LCD TV can be mounted on a Desktop as shown in the figure above.
- This is not floor-standing unit.

Installation Precautions

Wall Mounting

- Please secure enough space for safe use. (Please refer to A and B.)
- Installation of the LCD TV in an improperly ventilated location can cause a fire or damage to the LCD TV due to increased temperature.

A →
(Mounting on a wall)

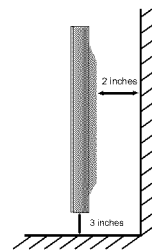
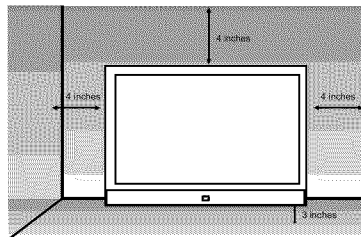

※ Contact your dealer to purchase the "Adjustable-angle wall mount" required for wall-mounted installation.

Using the Stand

- Do not install on an unstable location with support area smaller than the LCD TV.
- Please refer to the desktop stand user's manual for details of installation.

B →
(Using the Stand)

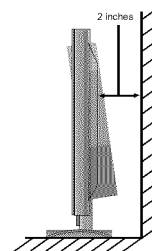
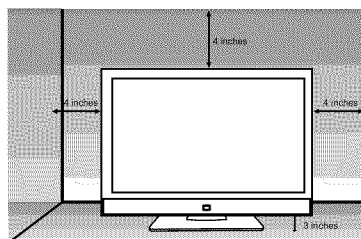

Installing an Antenna

- For connecting to ATSC or NTSC broadcasts

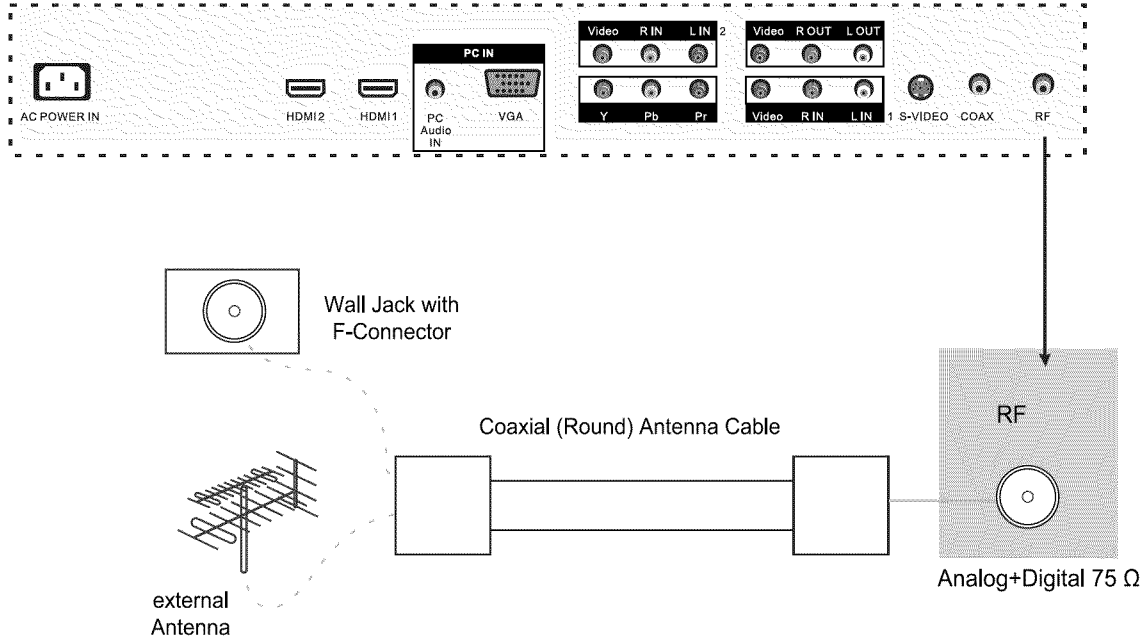

Press TV/AV button on the remote control to select TV, then press OK button to confirm.
Then you can receive the ATSC/NTSC signal.

Remote Control

● Functions of remote control buttons

The remote control is using Infra-Red (IR). Point it towards the front of the LCD TV. The remote control may not work correctly if it is operated out of range or out of angle.

POWER
Press to turn the TV on/standby

MUTE
Press to mute the sound.
Press again or press VOL+ to unmute.

CH+/-
Channel/Program +/-
VOL+/-
Volume +/-

PICTURE
Press repeatedly to cycle through the available video picture modes.

SOUND
Press to cycle through the different sound settings.

ASPECT
Press to cycle through the different screen display mode.

FREEZE
Press to catch the current picture.



TV/AV
Press to display the input source menu

CC
Press to display the closed caption.

MTS
Press to select the audio channels.

FAV
Press to display the favorite channels list.

EPG
Press to enter the EPG menu directly.

DISPLAY
Press to enter the EPG menu directly.

NUMBER BUTTONS
To select the program directly.
e.g.:
Select channel 5,
press "5" button.
Select channel 62
press "6" button, and press "2"
button in 2 seconds.
Select channel 152
press "1" button, and press "5"
button, then press "2" button
in 2 seconds.
select channel "5-1",
press "5" then "-/_" and "1".

Remote Control

THUMBSTICK (▲/▼/◀/▶/OK)

Allows you to navigate the on-screen menus and adjust the system settings to your preference.

MENU

Press to display the OSD menu.

RETURN

Press to Return to the previous channel viewed.



EXIT

Press to exit from the OSD menu.

TIMER

Press to setup the sleep time among: 5min, 10min, 15min, 30min, 45min, 60min, 90min, 120min, 180min, 240min and off.

Avoiding Remote Control Problems

1. Check the polarity (+,-) of the batteries in the remote control.
2. Check that the batteries have power.
3. Check that the LCD TV is powered and that it is properly plugged in.
4. Check if any three-wavelength lamp, special fluorescent or neon sign is turned on near the LCD TV.

Inserting Batteries in the Remote Control

1. Open the cover completely.
2. Insert the two supplied batteries (AA , 1.5V). Ensure that the polarities (+ and -) of the batteries are aligned correctly.
3. Slide back the cover.

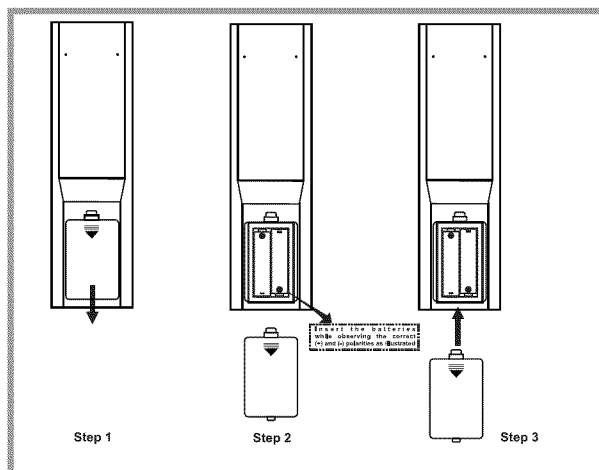

⚠ CAUTION : Risk of explosion if battery is replaced by an incorrect type.

Dispose of used batteries according to the national code (Recycling program).

How to use remote control

- The remote control should be operated within 30feet(7m) and 30 ° to the left and the right of the IR receiver at the front of the LCD TV.
- Used batteries should be disposed properly.

VCR Connections

- Connecting to the Composite terminal

※ Connection terminals of other equipments differ by manufacturer and model.

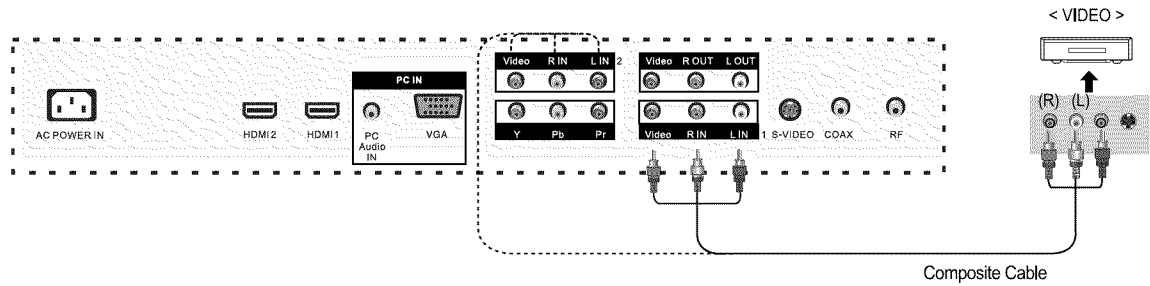

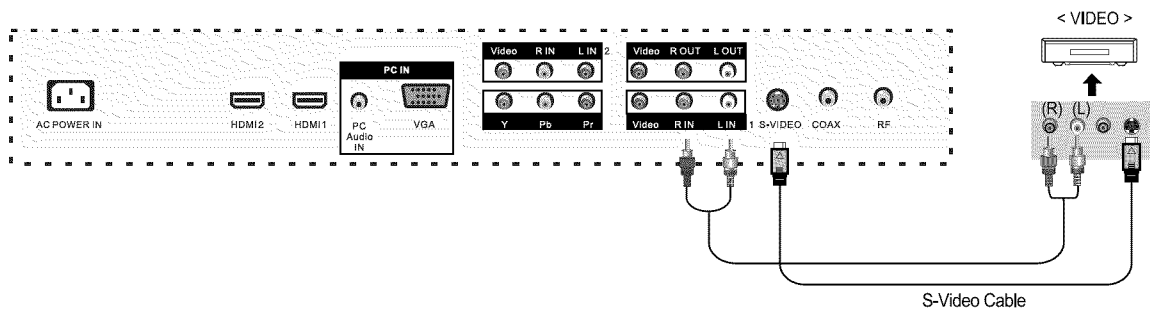

- Connect the LCD TV's Composite In terminal to the VCR's Composite Out terminal using the Composite cable. (Make sure the color of the terminals and the color of the cable are the same)

- Connecting to the S-Video terminal



※ Use the S-Video cable for higher picture quality.

Watching Video Tape

1. Turn on the LCD TV and press  on the remote control.
2. Use  to move to "AV 1 or 2", press OK button to confirm.
 - If S-Video has been connected, select "S-Video".
3. Turn on the VCR, insert the tape and press play button.

Satellite/ Cable TV Set-Top Box Connections

● Connecting to the Composite terminal

- ※ In order to watch Cable TV, Subscribe to your local Cable TV company and install a separate receiver(Set-Top-Box)
- ※ Connection terminals of other equipments differ by manufacturer and model.

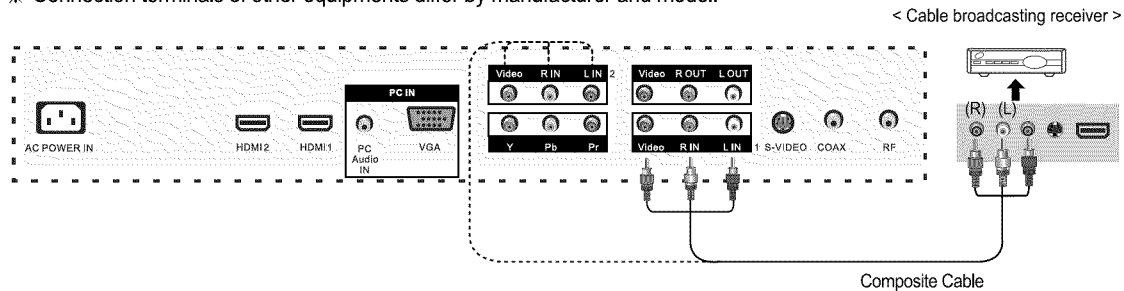

Connect the LCD TV's Composite In terminal to the cable broadcasting receiver Composite Out terminal using the Composite cable. (Make sure the color of the terminals and the color of cable are the same)

● Connecting to S-Video terminal

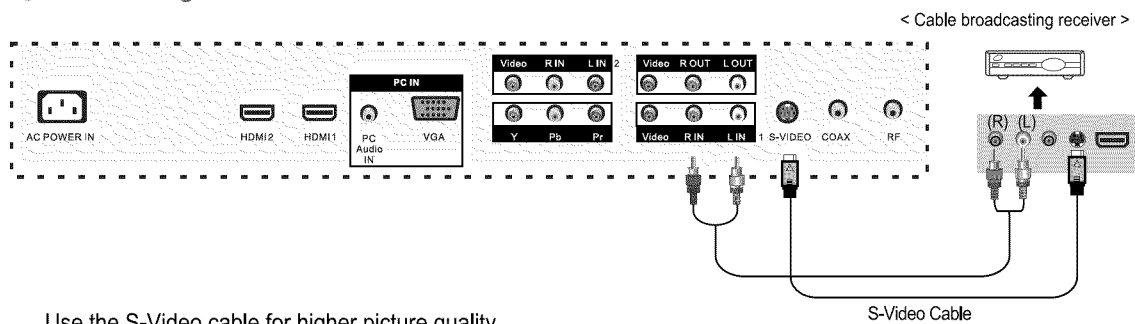

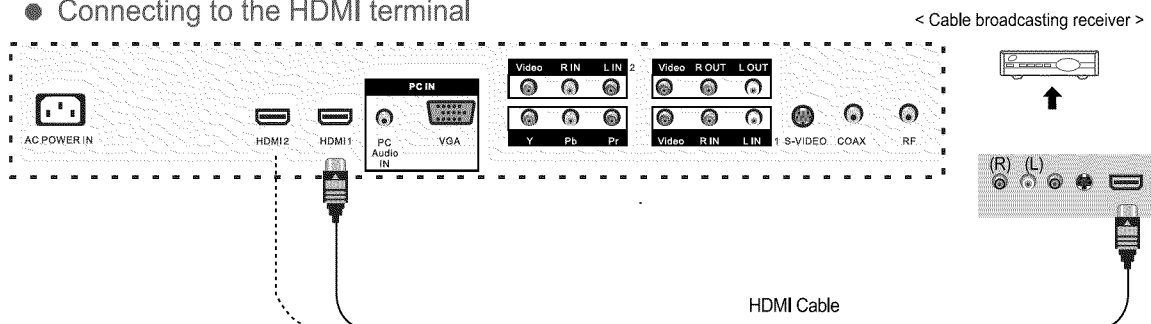

Use the S-Video cable for higher picture quality.

● Connecting to the HDMI terminal



Watching Cable TV

1. Turn on the LCD TV and press  on the remote control.
2. Use  to move to "AV 1 or 2", press OK button to confirm.
 - If S-Video has been connected, select "S-Video".
 - If HDMI has been connected, select "HDMI".
3. Turn on the cable broadcasting receiver and select the channel you wish to view.

DVD Connections

● Connecting to the component terminal

※ Connection terminals of other equipments differ by manufacturer and model.

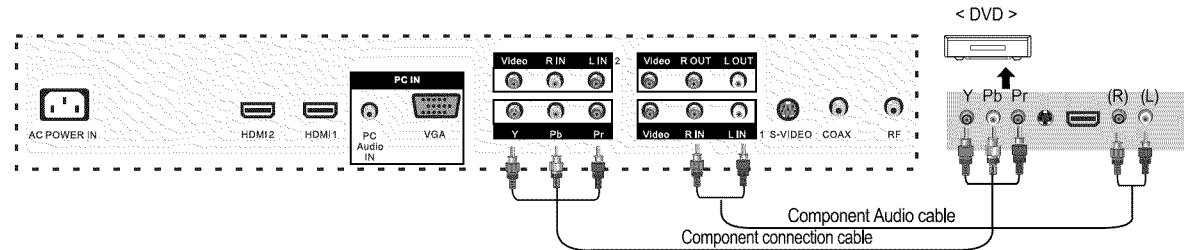

1. Connect LCD TV's Y, Pb, Pr terminal to DVD's Video Out terminal using the external cable.
2. Connect LCD TV's Audio terminals (left & right) in AV 1 to DVD's Audio Out terminal using the Audio cable.
3. It must match the component connection cable Y, Pb, Pr between the LCD TV and DVD Player.

● Connecting to the S-Video terminal

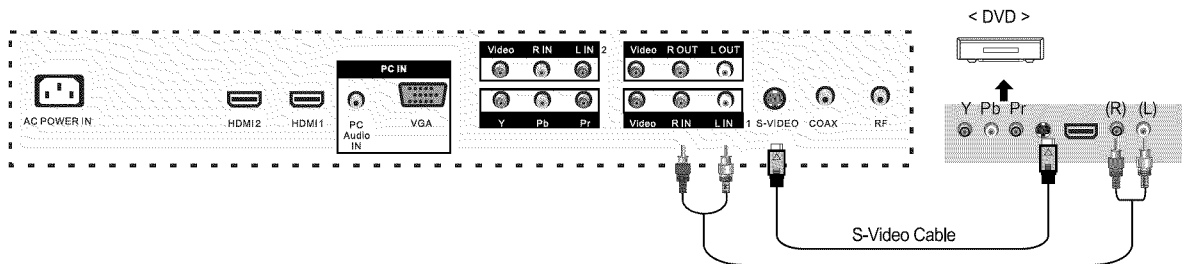

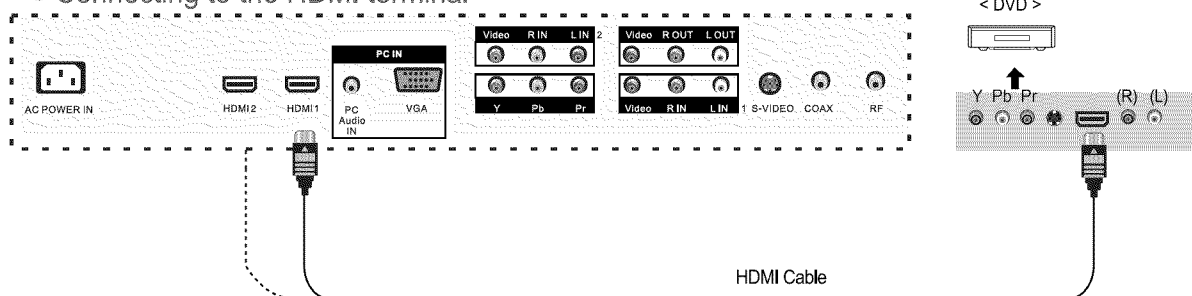

※ S-Video cable can be used if there is an S-Video terminal.

● Connecting to the HDMI terminal



· Connecting from HDMI terminal to HDMI terminal.

Playing the DVD

1. Turn on the LCD TV and press  on the remote control.
2. Use   to move to "YPbPr", press OK button to confirm.
 - If S-Video has been connected, select "S-Video".
 - If HDMI has been connected, select "HDMI".
3. Turn on the DVD, insert the DVD disc and press Play button.

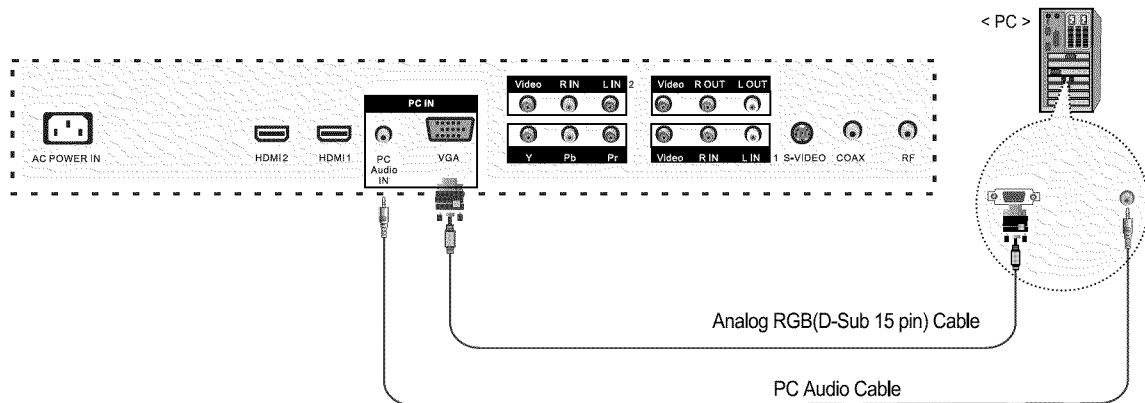

PC Connections

※ Connection terminals of other equipments differ by manufacturer and model.



- Connect LCD TV's PC Input terminal to PC's RGB terminal using the D-Sub cable.
- Connect LCD TV's PC Audio terminal to PC's Audio terminal using the Audio cable.
(Only for PC's with Audio terminal)

How to Use as PC monitor

1. Turn on the LCD TV and press  on the remote control.
2. Use  to move to "VGA", press OK button to confirm.

Audio Amplifier and Monitor Connections

- Connecting to the Audio Amplifier and Monitor
- ※ Connection terminals of other equipments differ by manufacturer and model.

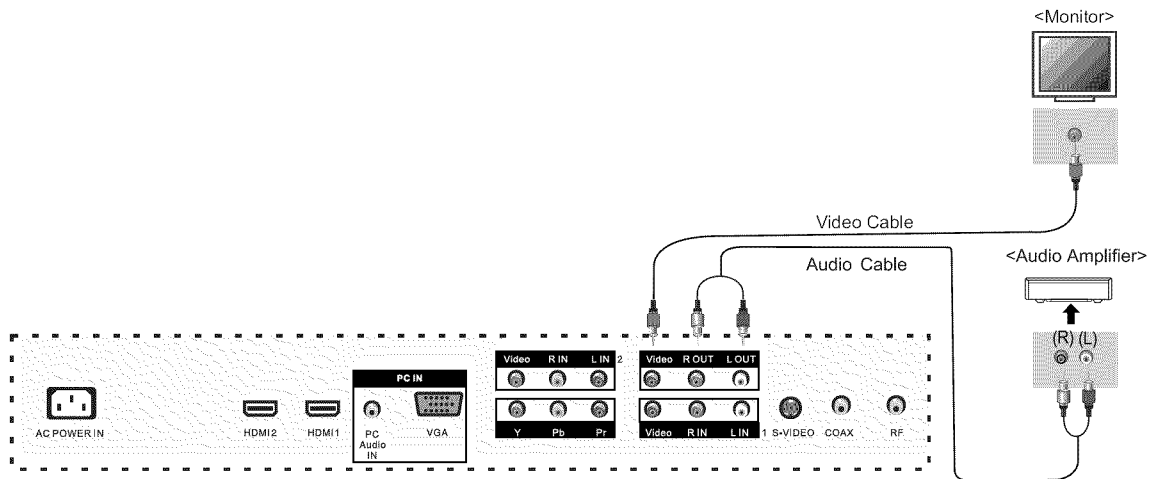

- Connect LCD TV's AUDIO(L/R) output terminal to Audio Amplifier using an audio patch cable.
Note: The speakers of LCD TV still have output audio signal at this time.
- You can use the Volume +/- buttons to adjust the output audio signal.

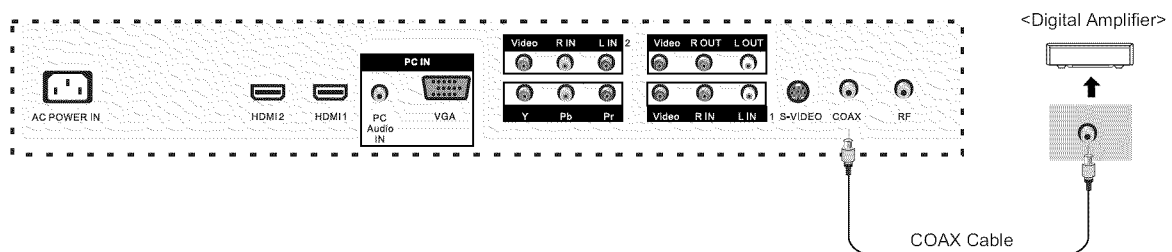

Digital Amplifier Connections

- Connecting to the Digital Amplifier
- ※ Connection terminals of other equipments differ by manufacturer and model.



Powering the LCD TV

- Power on/ off

Press  on the bottom of the LCD TV to  first.

- To turn the LCD TV on :
Press "POWER" button on the LCD TV.

- To turn the LCD TV off :
Press "POWER" button on the LCD TV.

- To turn on/off by remote control :

Press the  button of remote control.

Selecting Input Source

- You can select between the TV signal and the input signal of other equipments connected to the TV.
- Use this function to switch to the input source you wish to view.

Press  button on the remote control.

Use  to move to the desired input source.

Press  to select.

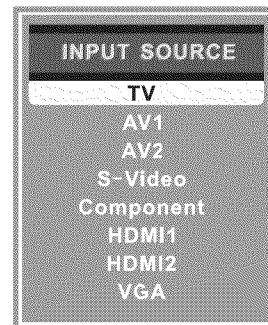

Operating the Menu

1. After you turn on the TV and select the input source, you should setup the on-screen menu.
2. Press MENU button to display the on-screen menu.
3. Press ◀/▶ button to select the main menu: PICTURE, AUDIO, TIMER, SETUP, LOCK, CHANNEL.
4. Press ▼ button to enter the main menu.

PICTURE MENU:

Allows you to make adjustments to your picture settings.
(select TV source for example)

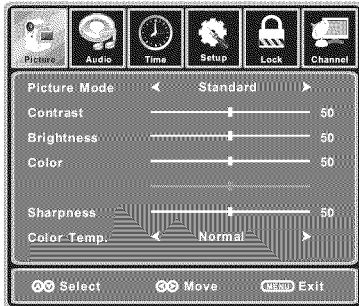

AUDIO MENU:

Allows you to customize the sound options and effects.
(Select TV source for example)

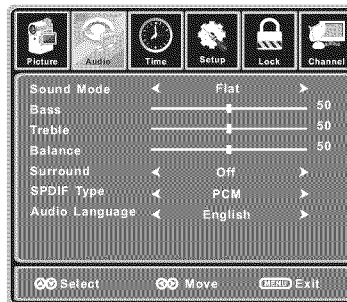

TIME MENU:

Allows you to set up a variety of timer options.
(Select TV source)



SETUP MENU:

Allows you to set up a variety of setup options.
(Select TV source)

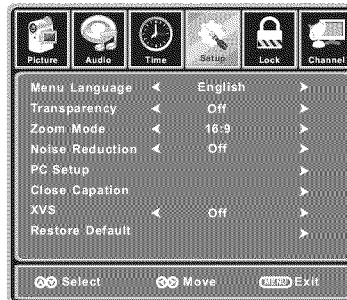

LOCK MENU:

Allows you to set up a variety of lock options.
(Select TV source)

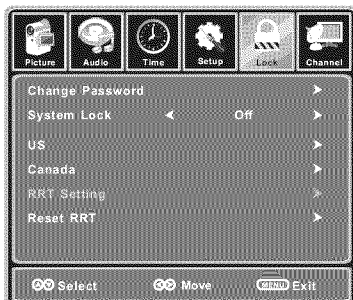

CHANNEL MENU:

Allows you to search channels and set up a variety of channel options.
(Select TV source)

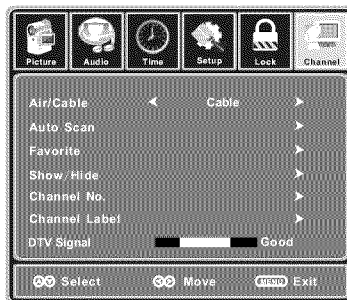

5. Press ▼/▲ button to select the item in the main menu.
6. Press ◀/▶ button to adjust or select;
Press ▶ button to enter the submenu.
7. Press EXIT button to exit the menu or press MENU button to go back to the previous menu.

Note:

1. Only when you input the suitable signal, the relevant items can be activated.
2. You should according to the hints on the bottom of menu.

Customizing the PICTURE Settings

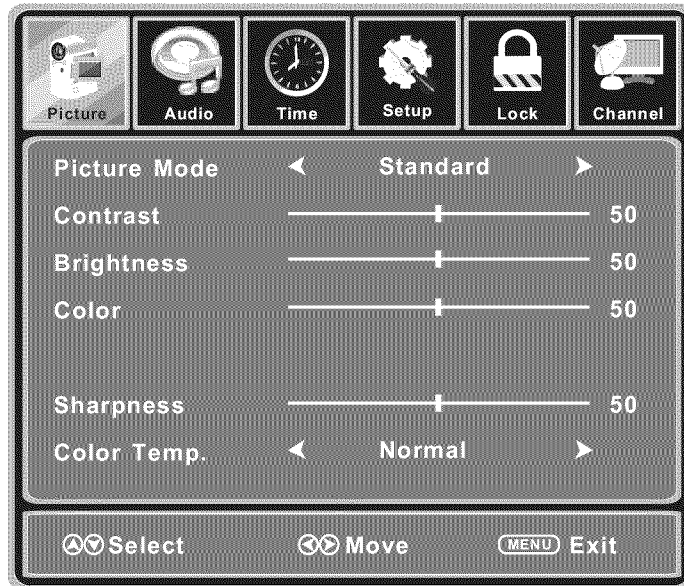

The PICTURE menu includes the following options :

Picture Mode	Cycles among picture display modes: Standard, Dynamic, Mild, Sports, User.
Contrast	Controls the difference between the brightest and darkest regions of the picture.
Brightness	Controls the overall brightness of the picture
Color	Controls the color.
Tint	Controls the fresh tones so they appear natural.
Sharpness	Control the amount of fine detail in the picture.
Color Temp.	Cycles among color modes: Normal, Cool, Warm.

Customizing the SOUND Settings

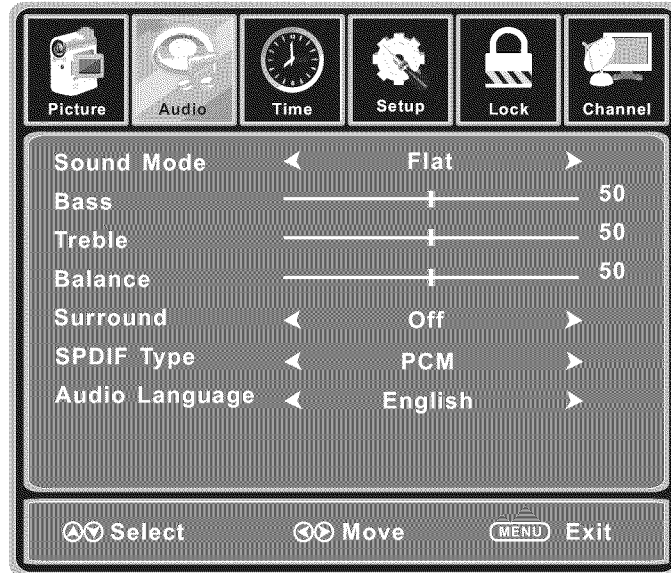

The SOUND menu includes the following options :

Sound Mode	Allows you to select among: Flat, Music, Movie, Sports and User.
Bass	Controls the relative intensity of lower pitched sounds.
Treble	Controls the relative intensity of higher pitched sounds
Balance	To adjust the balance of the left and right sound track, or turn off the volume of the left and right sound track.
Surround	To turn on or off the Surround function.
SPDIF Type	Allows you to select between PCM and RAW.
Audio Language	Allows you to select audio languages among.

Customizing the TIMER Settings



The TIMER menu includes the following options :

Sleep Timer	Allows you to set up the sleep timer among: 5min, 10min, 15min, 30min, 45min, 60min, 90min, 120min, 180min, 240min and off.
Time Zone	Allows you to set up the sleep timer among: Pacific, Alaska, Hawaii, Eastern, Central and Mountain.
Daylight Saving Time	Allows you to turn on or off the daylight saving time.

Customizing the SETUP Settings



The SETUP menu includes the following options:

Menu Language	Allows you to select menu language among: English, Français, Español and Deutsch.
Transparency	Allows you to turn on or off the transparency function.
Zoom Mode	Allows you to select the zoom mode among: 16:9, 16:9 zoom, 4:3, 4:3 zoom.
Noise Reduction	Allows you to select the noise reduction mode among: Strong, Off, Weak, Middle.
PC Setup	Input PC signal first, then press TV/AV button to select VGA mode, press OK button to confirm.

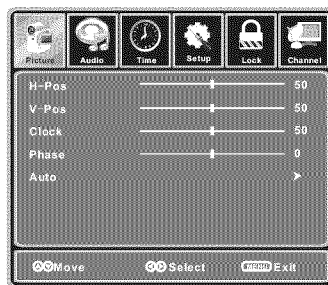

- H-Position Allow you to use ◀ and ▶ button to adjust the H Position.
- V-Position Allow you to use ◀ and ▶ button to adjust the V Position.
- Clock Allow you to prolong the image.
- Phase Allow you to adjust the definition.
- Auto Select "Auto" and press ▶ button, the unit will automatically adjust all items to achieve a best effect.

Customizing the SETUP Settings

Close Caption

Use ▼ button to highlight the Close Caption item, then press ► button to enter into the following menu.

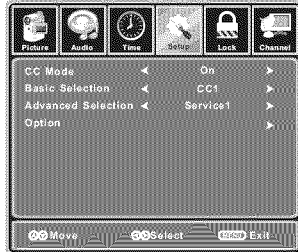

CC Mode Allows you to select the CC Mode among: On, Off and CC on Mute.

Basic Selection Allows you to select the basic selection among: CC1, CC2, CC3, CC4, Text1, Text2, Text3 and Text4.

Advanced Selection Allows you to select the advanced selection among: Service1, Service2, Service3, Service4, Service 5 and Service 6.

Option Use ▼ button to highlight the “Option” item, then press ► button to enter into the following menu.

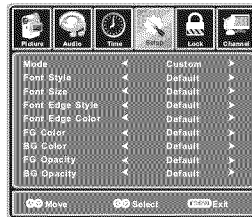

Use ▲ and ▼ buttons to highlight the desired item, and use ◀ and ▶ buttons to select.

XVS Turn on/off the function to adjust the dynamic brightness automatically.

Restore Default Restores all settings in SETUP menu to factory settings.

Customizing the LOCK Settings

You should enter the password to enter the Lock menu.
NOTE: the factory password is 0000.

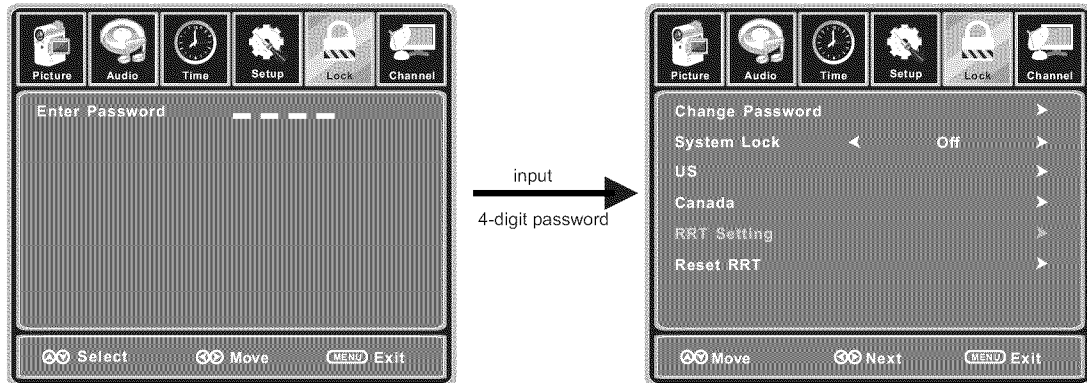

The LOCK menu includes the following options :

Change Password

Use ▼ button to select the “Change Password” item, then press ► button to enter into the following menu.

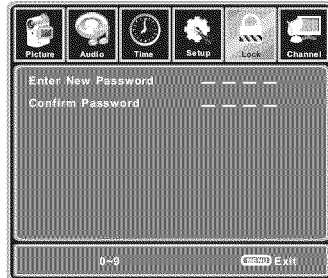

Input the new 4digit password and input it again to confirm.

System Lock

Allows you to turn on or off the system lock.
If you turn off the system lock, then the following items(US, Canada, RRT Setting and Reset RRT) will unable to use.

Customizing the LOCK Settings

US

Use ▼ button to highlight the “US” item, then press ► button to enter into the following menu.

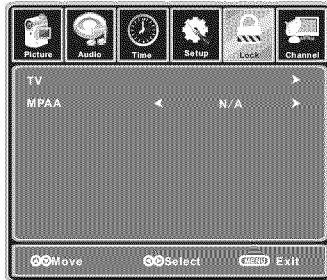

TV

Use ▼ button to highlight the “TV” item, then press ► button to enter into the following menu.

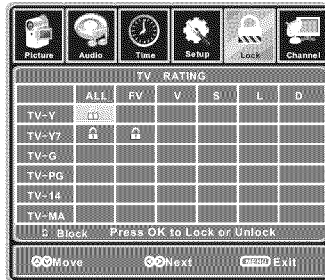

Use ▼ and ▲ buttons to select the desired rating and press ► button to block or unblock rating.

MPAA

The Movie rating (MPAA) is used for original movies rated by the Motion Picture Association of America (MPAA) as broadcasted on cable TV and not edited for television.

Use UP or DOWN button to select N/A, G, PG, PG-13, R, NC-17 or X.

RATING	DESCRIPTION
G	General Audiences. Movie is appropriate for all ages.
PG	Parental Guidance Suggested. May contain material not suited for younger viewers.
PG-13	Contains content that may not be appropriate for viewers under the age of 13.
R	Restricted. Contains adult content, no one under 17 admitted without parent.
NC-17	No one 17 and under admitted.
X	Adults only.

Customizing the LOCK Settings

Canada

Use Down button to highlight the “Canada” item, then press RIGHT button to enter into the following menu.

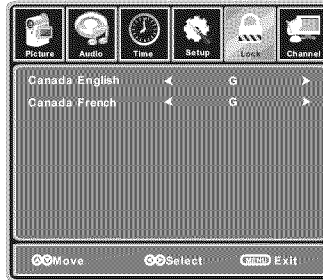

Canada English Use LEFT and RIGHT buttons to select among: E, C, C8+, G, PG, 14+ and 18+

Canada French Use LEFT and RIGHT buttons to select among: E, G, 8ans+, 13ans+, 16ans+ and 18ans+

RRT Setting

Reset RRT

Allows you to reset the RRT setting.

Customizing the CHANNEL Settings

The Channel menu could only be operated in TV source.



COLOR TV BROADCASTING SYSTEM

Country	Color System	Sound System
AZORES(PORTUGAL)	PAL	B/G
BALKANS(KOSOVO, BOSNIA)	PAL	B/G
BELGIUM/GERMANY/ITALY	PAL	B/G
IRAQ	SECAM	B
AFGHANISTAN	PAL	B
NETHERLANDS/NORWAY	PAL	B/G
SAUDI ARABIA	SECAM	B
	PAL	B
KUWAIT/TURKEY/JORDAN	PAL	B/G
UNITED KINGDOM	PAL	I
CZECH/HUNGARY/POLAND	PAL	D/K
RUSSIA	SECAM	D/K
U.S.A./JAPAN/KOREA/GUAM	NTSC	M

The CHANNEL menu includes the following options :

Air/Cable

Allows you to select antenna between Air and Cable.
If you select "Cable", the following items(Favorite, Show/Hide, Channel NO., Channel Label and DTV Signal) are unable to use.

Auto Scan

Use ▼ button to highlight the "Auto Scan" item, then press ► button to enter into the following menu.

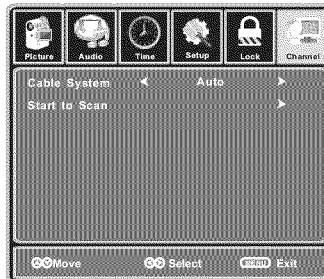

If you select "Air" as input signal in Antenna item, you can press ► button to search the channels automatically.

The receivable channels will be stored automatically.
When searching channels, press MENU to stop.

NOTE: It will take a while (about 10 minutes) to auto scan in NTSC or ATSC mode, please wait patiently.

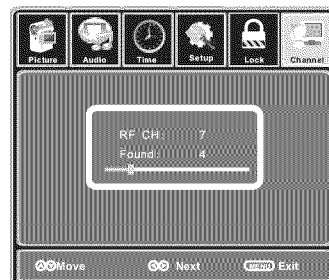

Customizing the CHANNEL Settings

If you select "Cable" as input signal in Antenna item, allows you to select Cable System among: Auto, STD, IRC and HRC.
 Use ▼ button to highlight the "Start to Scan", then press ► button to search the channels automatically.
 The receivable channels will be stored automatically.
 When searching channels, press MENU to stop.

Favorite

Allows you to add these channels which you desired as the favorite channels.
 Use ▼ or ▲ button to highlight the "Favorite" item, then press ► button to enter into the following menu.

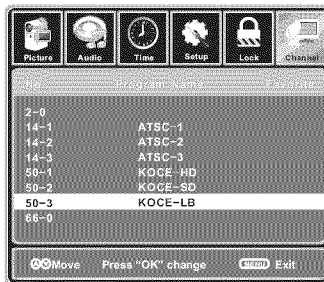

Use ▼ and ▲ button to highlight the desired item, then press OK button to add or remove the highlighted channel as favorite.

Show / Hide

Allows you to show or hide the channels.
 Use ▼ or ▲ button to highlight the "Show / Hide" item, then press ► button to enter into the following menu.

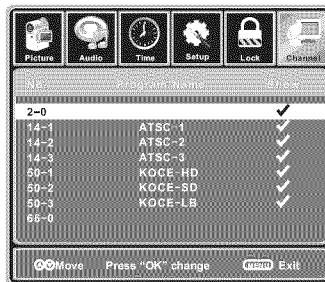

Use ▼ and ▲ button to highlight the desired item, then press OK button to show or hide the highlighted channel.

Channel No.

Press ► button to Show and select the channel.

Channel Label

Allows you to setup a label for the channel.
 Press ► button to select the position of the table, and press ▼ and ▲ button to select the words.

DTV Signal

Show the quality of digital signal: good, Normal, Bad.

Component video(YPbPr) input

MODE	RESOLUTION
480i	720X480
480p	720X480
576i	720X576
576p	720X576
720p	1280X720
1080i	1920X1080
1080p	1920X1080

PC-RGB input

MODE	RESOLUTION	HORIZONTAL FREQUENCY(KHz)	VERTICAL FREQUENCY(Hz)
DOS	720X400	31.50	70.00
VGA	640X 480	31.50/37.90/37.50	60.00/72.00/75.00
SVGA	800X 600	37.90/47.20/46.90	60.00/72.00/75.00
XGA	1024X 768	48.40/56.50/60.00	60.00/70.00/75.00

HDMI input

MODE	RESOLUTION
480i	720X480
480p	720X480
576i	720X576
576p	720X576
720p	1280X720
1080i	1920X1080
1080p	1920X1080

- Do not use other functions that are not mentioned in this user's manual.
- In case a problem occurs with your LCD TV, please take the following steps first.
- If you still have the problem, turn the power off and contact your dealer or an authorized service center.

Problem	Action
The screen does not appear.	Is the power plug pulled out? Insert the power plug. Press the power button of the remote control.
The screen appears too slowly after the power is turned on.	This problem occurs for a brief time in the process of image elimination processing in order to hide temporary screen noise that occurs when the power is turned on. But if the screen does not come after 1 minute contact your dealer or an authorized service center.
Screen is too bright or too dark.	Perform brightness adjustment or Contrast adjustment.
Screen is too large or too small.	Adjust the screen size.
Stripes appear on the screen and it shakes.	Stop using wireless telephones, hair driers and electric drills.
Screen appears, Voice is not heard	<ol style="list-style-type: none"> 1. Press the "MUTE" button. 2. Increase the sound level by pressing volume adjustment button. 3. Check if sound terminal of external input is connected properly. 4. Check if audio cables are connected properly. 5. Select and check the other input. <p>If the sound still does not work and the other channels are the same after you have done as the above, contact your dealer or an authorized service center.</p>
Remote control does not work	<ol style="list-style-type: none"> 1. Check if main power is On. 2. Check that the batteries of the remote controller were loaded properly. 3. Check to see if any obstacle exists between the LCD TV and the remote control, then remove it, if any. 4. If the batteries have no power, replace them with two new batteries.

- This LCD TV is for household use and registered as harmless on electromagnetic waves.
- Therefore, you can use it in every location as well as residential areas.

Specifications

LCD Panel	Panel Size	47" TFT LCD
	Brightness	500cd/m2
	Contrast Ratio	1000:1
BROADCAST SIGNAL SYSTEM		NTSC M + ATSC, PAL, SECAM, DK/BG/I
ANTENNA INPUT IMPEDANCE		x1
SOUND OUTPUT		10W x2
Max. Resolution		1920 x 1080
Input Connector	VIDEO	2
	S-VIDEO	1
	YPbPr	1
	AUDIO (L/R)	2
	PC/AUDIO(L/R)	1
	HDMI	2
	RF	1
Output Connector	VIDEO	1
	AUDIO (L/R)	1
	SPDIF	1
Power Source	AC 100-240V, 50/60HZ	
Power Consumption	300W	

- The cabinet design and electronics specifications will be modified without prior notice for improving the performance.
- Weight and dimensions are approximate

VIORE™ LIMITED WARRANTY

FLAT PANEL TELEVISION

This **VIORE** brand Product, as supplied and distributed by **VIORE** and delivered new in the original carton to the original purchaser is warranted by **VIORE** against manufacturing defects in materials and workmanship for a limited warranty period of one (1) year on parts and labor. However, there will be only a 90 day parts and labor limited warranty for commercial use.

This Limited Warranty does not apply to store display products and product sold as a "marked down" special, in "as is" condition, "open box", products missing accessories, no fault found or damaged at time of delivery to Viore.

Proof of purchase within one year from date of purchase in the form of a Bill of Sale, Receipt or Receipted Invoice is evidence the Product is within the limited warranty period. The Bill of Sale, Receipt or Receipted Invoice must be presented as a pre-condition to obtaining the limited warranty service.

This limited warranty begins on the original date of purchase, and is valid only on Products purchased through **VIORE** authorized dealers and used in the United States by the original purchaser. To receive warranty service, the purchaser must contact **VIORE** for problem determination and service procedures. Warranty service may only be performed by a duly authorized **VIORE** service center. The original dated bill of sale, receipt or receipted invoice must be presented upon request as proof of purchase to **VIORE** or **VIORE's** authorized service center.

VIORE will repair or if repairs cannot be made, **VIORE** will replace this Product at no charge if the Product is defective as specified in this limited warranty during the limited warranty period. **VIORE** may use new, or remanufactured parts or products to repair or replace the Product at its sole discretion. All replaced parts and Products become the property of **VIORE** and must be returned to **VIORE**. Replacement parts and Products assume the remaining original limited warranty, or ninety (90) days, whichever is longer.

Product freight needs to be prepaid by original purchaser and shipped in either its original packaging or packaging affording an equal degree of protection. **VIORE** shall not be responsible for or obligated to replace damaged goods. If you reside in California and you cannot transport the television due to the size, weight, and method of attachment, **VIORE** will provide transportation for the television to the repair facility. If you reside in a state other than California, you are responsible for the costs of transporting the television to a repair facility.

If the product is received damaged by **VIORE**, it is the responsibility of the consumer to file a claim against the carrier. **VIORE** will only store the damaged product for 30 days and reserves the right, in its sole discretion, to dispose of the damaged product or ship it back to the consumer at consumer's expense after 30 days.

This limited warranty covers manufacturing defects in materials and workmanship encountered in normal, and except to the extent otherwise expressly provided for in this statement, noncommercial use of this product, and shall not apply to the following, including, but not limited to: damage which occurs in shipment; delivery and installation; applications and uses for which this product was not intended; altered product or serial numbers; cosmetic damage or exterior finish; accidents, abuse, neglect, fire, water, lightning or other acts of nature; use of products, equipment, systems, utilities, services, parts, supplies, accessories, applications, installations, repairs, external wiring or connectors not supplied or authorized by **VIORE** which damage this product or result in service problems; incorrect electrical line voltage, fluctuations and surges; customer adjustments and failure to follow operating instructions, cleaning, maintenance and environmental instructions that are covered and prescribed in the instruction book; reception problems and distortion related to noise, echo, interference or other signal transmission and delivery problems; burned-in images. **VIORE** does not warrant uninterrupted or error-free operation of the product.

THERE ARE NO EXPRESS WARRANTIES OTHER THAN THOSE LISTED AND DESCRIBED ABOVE, AND NO WARRANTIES WHETHER EXPRESS OR IMPLIED, INCLUDING, BUT NOT LIMITED TO, ANY IMPLIED WARRANTIES OF MERCHANTABILITY OR FITNESS FOR A PARTICULAR PURPOSE, SHALL APPLY AFTER THE EXPRESS WARRANTY PERIODS STATED ABOVE, AND NO OTHER EXPRESS WARRANTY OR GUARANTY GIVEN BY ANY PERSON, FIRM OR CORPORATION WITH RESPECT TO THIS PRODUCT SHALL BE BINDING ON VIORE. REPAIR OR REPLACEMENT AS PROVIDED UNDER THIS LIMITED WARRANTY IS THE EXCLUSIVE REMEDY OF THE CONSUMER. VIORE SHALL NOT BE LIABLE FOR ANY INCIDENTAL, OR CONSEQUENTIAL DAMAGES FOR BREACH OF ANY EXPRESS OR IMPLIED WARRANTY ON THIS PRODUCT; EXCEPT TO THE EXTENT PROHIBITED BY APPLICABLE LAW, ANY IMPLIED WARRANTY OF MERCHANTABILITY OR FITNESS FOR A PARTICULAR PURPOSE ON THIS PRODUCT IS LIMITED IN DURATION TO THE DURATION OF THIS LIMITED WARRANTY. THIS LIMITED WARRANTY SHALL NOT EXTEND TO ANYONE OTHER THAN THE ORIGINAL PURCHASER OF THIS PRODUCT, IS NONTRANSFERABLE AND STATES YOUR EXCLUSIVE REMEDY.

Some states do not allow limitations on how long an implied warranty lasts, or the exclusion or limitation of incidental or consequential damages, so the above limitations or exclusions may not apply to you. This warranty gives you specific legal rights, and you may also have other rights which vary from state to state. Any provision contained herein which is found contrary to state or local laws shall be deemed null and void and the remaining provisions shall continue in full force and effect.

To obtain warranty service, please contact **VIORE** at:

Phone: 877-777-1428
www.viore.com