

VIORETM TECHNOLOGY & INNOVATION

OPERATING INSTRUCTIONS

26" HD LCD Television with Built-in DVD Player LCD26VH59

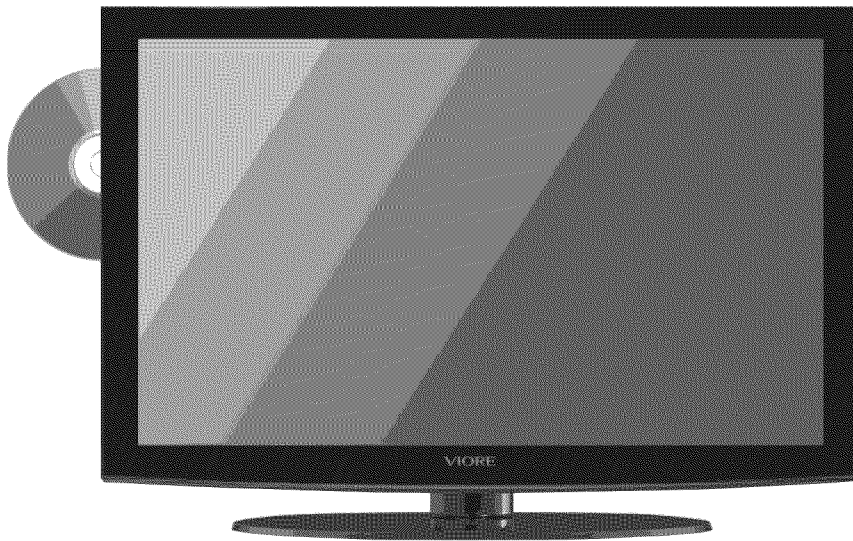

AIR (TV)/CABLE MODE SELECTION

The Air/CABLE menu option is set to the "CABLE" (Cable Television) mode at the factory. If you want to use an antenna for the built-in TV tuner, this menu option must be set to the "Air" mode. Please refer to page 17 of the owner's manual for the details of this menu.



CONTENTS

Safety Precautions

- Caution 1
- Safety Information 2

User Guidance Information

- Names of each part(Front View) / Accessories 3
- Names of each part(Back View) 4
- Mounting on a Desktop / Installation Precautions 5
- Installing an Antenna 6
- Remote control 7-8
- Precautions / How to use remote control 9

Basic Use

- Powering the LCD TV / Selecting input source 10

Application

- Operating the Menu 11
- Customizing the PICTURE Settings 12
- Customizing the SOUND Settings 13
- Customizing the TIMER Settings 14
- Customizing the SETUP Settings 15
- Customizing the LOCK Settings 16
- Customizing the CHANNEL Settings 17
- DVD Operation 19-25

Maintenance and Service

- Trouble shooting 26
- Specifications 27

Caution



The lightening flash with arrowhead symbol, within an equilateral triangle is intended to alert the user to the presence of un-insulated "dangerous voltage" within the products enclosure that may be of sufficient magnitude to constitute a risk of electric shock to the persons.



The exclamation point within an equilateral triangle is intend to alert the user to the presence of important operating and maintenance (servicing) instructions in the literature accompanying the appliance.



Correct disposal of this Product

Waste Electrical & Electronic Equipment (WEEE)

Your product is designed and manufactured with high quality materials and components which can be recycled and reused.

This symbol means that electrical and electronic equipment, at their end-of-life, should be disposed of separately from your household waste.

Please dispose of this equipment at your local community waste collection/recycling centre.

In the European Union there are separate collection systems for used electrical and electronic products. Please help us to conserve the environment we live in!

Safety Information

To ensure reliable and safe operation of this equipment, please read carefully all the instructions in this user guide, especially the safety information below.

Electrical safety

- The TV set should only be connected to a mains supply which matches that stated on the label.
- To prevent overload, don't share the same mains supply socket with too many other items of equipment.
- Do not place any connecting wires where: they may be stepped on or tripped over.
- Do not place heavy items on them, which may damage the leads.
- Hold the main plug, not the wires, when removing from a socket.
- During a thunderstorm or while leaving the TV for long periods, set the switch off.
- Do not allow water or moisture to enter the TV or mains adaptor. Do NOT use in wet or moist areas, such as Bathrooms, steamy kitchens or near swimming pools.
- Pull the plug out immediately, and seek professional help if: the mains plug or cable is damaged, liquid is spilt onto the set, or if it is accidentally exposed to water or moisture, anything accidentally penetrates the ventilation slots, the set doesn't work normally.
- Do not remove the safety covers. There are no user serviceable parts inside. You may invalidate the warranty. This apparatus must only be serviced by qualified personnel.
- To avoid battery leakage, remove exhausted batteries from the remote control, or when not using for a long period.
- Do not break open or throw exhausted batteries on a fire.

Physical safety

- Do not block ventilation slots in the back cover. You may place the TV in a cabinet, but ensure at least 5cm (2") clearance all around.
- Do not tap or shake the TV screen, or you may damage the internal circuits. Take good care of the remote control.
- To clean the TV use a soft dry cloth. Do not use solvents or petrol based fluids.
- Do not install near any heat sources such as radiators, heat registers stoves or other apparatus (including amplifiers) that produce heat.
- Do not defeat the safety purpose of the polarized or grounding-type plug. A polarized plug has two blades with one wider than the other. A grounding type plug has two blades and a third grounding prong, the wide blade or the third prong is provided for your safety. If the provided plug does not fit into your outlet, consult an electrician for replacement of the obsolete outlet.
- Protect the power cord from being walked on or pinched particularly at plugs.
- Use only attachments/accessories specified by the manufacturer.
- Unplug this apparatus during lightning storms or when unused for long periods of time.
- Refer all servicing to qualified service personnel. Servicing is required when the apparatus has been damaged in any way, such as power-supply cord or plug is damaged, liquid has been spilled or objects have fallen into the apparatus, has been exposed to rain or moisture, does not operate normally or has been dropped.
- Please always connect an apparatus with Class I structure to a main socket with protective earthing connection.
- Please make sure both main plug and appliance coupler work properly.

Names of each part

Front View

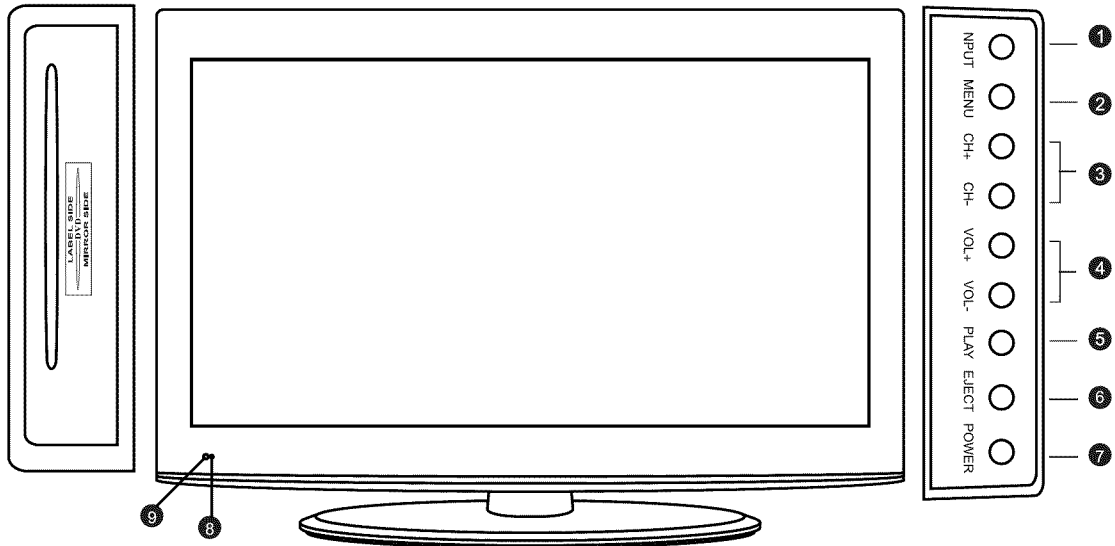

- | | |
|---------------------------------------------|-------------------------|
| ① INPUT button - Input Source Select Button | ⑥ EJECT- DVD eject. |
| ② MENU button - OSD Menu Display Button | ⑦ POWER button |
| ③ CH+/- button - Channel/Program +,- Button | ⑧ LED Indicator |
| ④ VOL+/- button - Volume +,- Button | ⑨ Remote Control Window |
| ⑤ PLAY- Play/Pause DVD program. | |

Accessories

- The configuration of the components may look different from the following illustration.

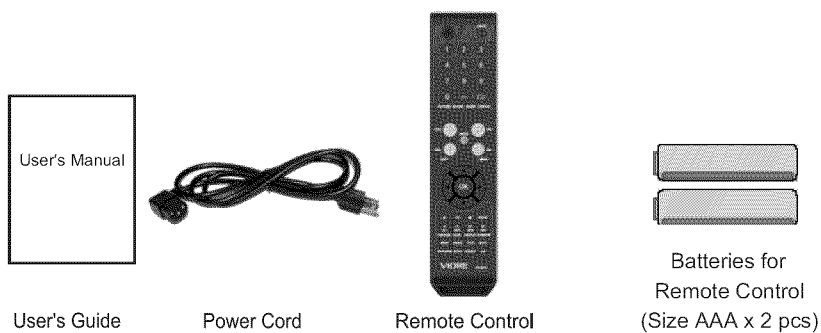

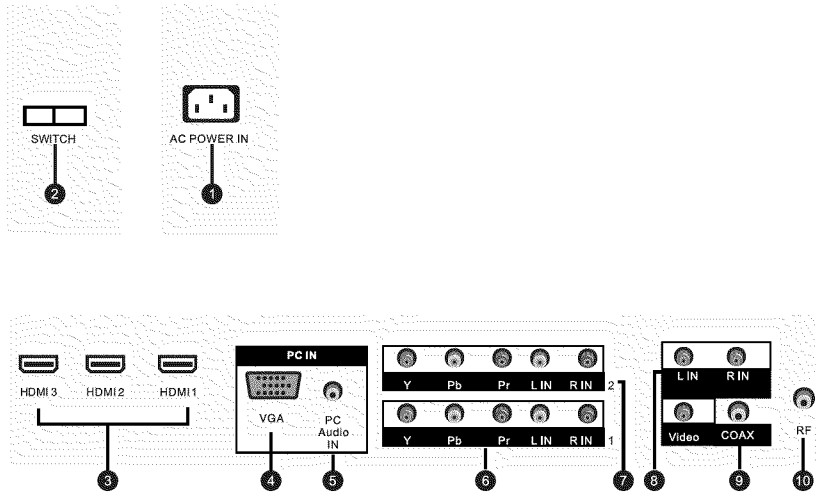

Names of each part



1. **AC POWER IN:** Connect to an earth 100-240V, 50/60Hz AC outlet with the Power Cable.
2. **SWITCH:** Switch on or off the power supply.
3. **HDMI1/2/3:** Connect them to the video output terminal of DVD.(used in HDTV1 mode)
4. **VGA:** For PC display. Connect it to the D-Sub 15 pins analog output connector of the PC.
5. **PC AUDIO IN:** Connect it to the audio output terminal of PC.
6. **YPbPr 1:** Connect them to the video output terminal of DVD.(used in HDTV1 mode).
L/R in 1: Connect them to the audio output terminal of DVD(with YPbPr 1)
7. **YPbPr 2:** Connect them to the video output terminal of DVD.(used in HDTV2 mode).
L/R in 1: Connect them to the audio output terminal of DVD(with YPbPr 2).
8. **VIDEO:** Connect it to video output terminal of DVD.
L/R in: Connect them to audio output terminal of DVD.
9. **COAX:** Digital coaxial output.
10. **RF:** Connect antenna or cable 75 Ohm coaxial to receive TV signal.

- To turn on the LCD TV

Press  on the LCD TV to  first.

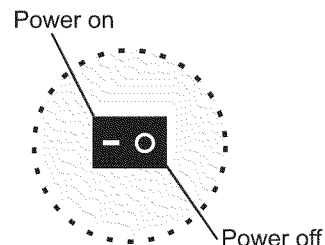

- Be sure to turn off the power and unplug both units from the wall outlet before making any connections.

Mounting on a Desktop

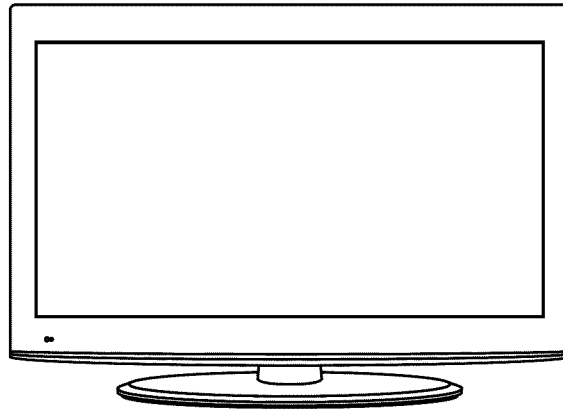

- Your LCD TV can be mounted on a Desktop as shown in the figure above.
- This is not floor-standing unit.

Installation Precautions

Wall Mounting

- Please secure enough space for safe use. (Please refer to A and B.)
- Installation of the LCD TV in an improperly ventilated location can cause a fire or damage to the LCD TV due to increased temperature.

A →
(Mounting on a wall)

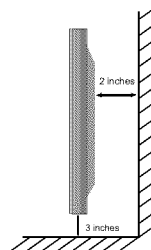
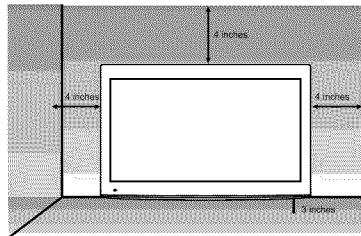

※ Contact your dealer to purchase the "Adjustable-angle wall mount" required for wall-mounted installation.

Using the Stand

- Do not install on an unstable location with support area smaller than the LCD TV.
- Please refer to the desktop stand user's manual for details of installation.

B →
(Using the Stand)

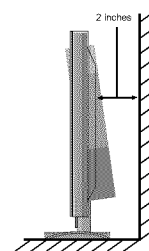
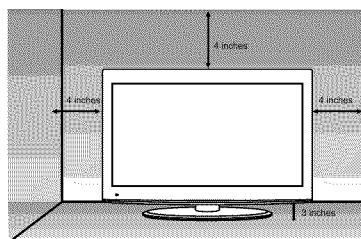

Installing an Antenna

- For connecting to ATSC or NTSC broadcasts

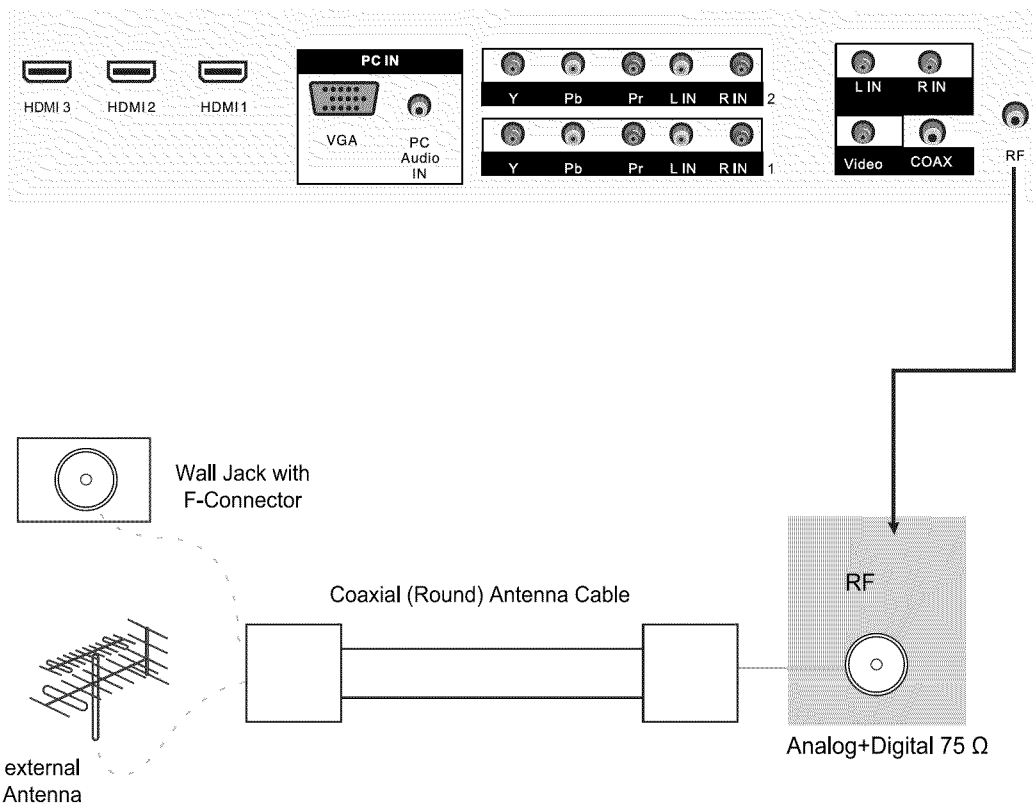

Press TV/AV button on the remote control to select TV, then press OK button to confirm.
Then you can receive the ATSC/NTSC signal.

Remote Control

● Functions of remote control buttons

The remote control is using Infra-Red (IR). Point it towards the front of the LCD TV. The remote control may not work correctly if it is operated out of range or out of angle.

POWER

Press to turn the TV on/standby

PICTURE

Press repeatedly to cycle through the available video picture modes.

SOUND

Press to cycle through the different sound settings.

SLEEP

Press to setup the sleep time

DISPLAY

Press to enter the EPG menu directly.

CH+/-

Channel/Program +/-

VOL+/-

Volume +/-

MENU

Press to display the OSD menu.

EXIT

Press to exit from the OSD menu.

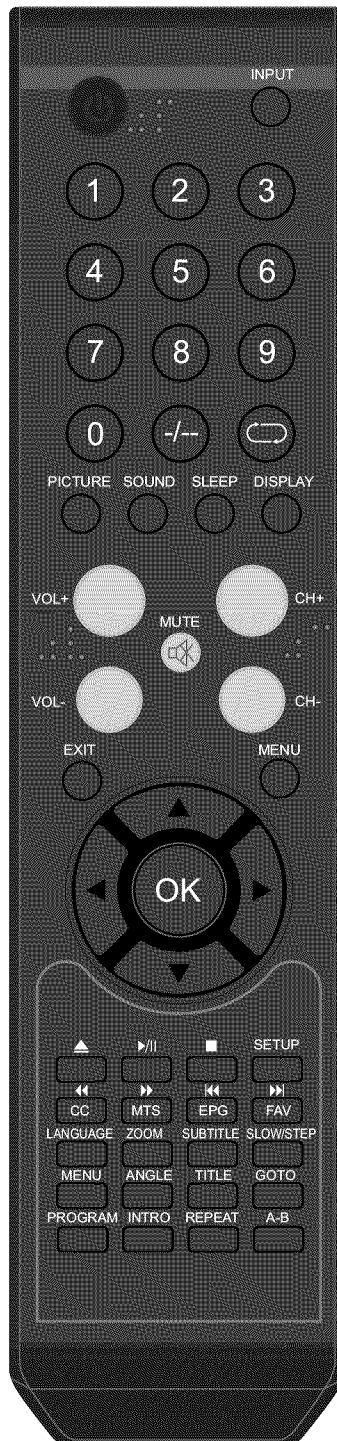

INPUT

Press to display the input source menu

NUMBER BUTTONS

To select the program directly. e.g.:

Select channel 5, press "5" button.

Select channel 62

press "6" button, and press "2" button in 2 seconds.

Select channel 152

press "1" button, and press "5" button, then press "2" button in 2 seconds.

select channel "5-1",

press "5" then "-/—" and "1".



Return to the previous channel viewed.

MUTE

Press to mute the sound.

Press again or press VOL+ to unmute.

THUMBSTICK (▲/▼/◀/▶/OK)

Allows you to navigate the on-screen menus and adjust the system settings to your preference.

CC

Press to display the closed caption.

MTS

Press to select the audio channels.

EPG

Press to enter the EPG menu directly.

FAV

Press to display the favorite channels list.

Remote Control

- ▲ DVD eject.
- ▶/|| Play/Pause DVD program.
- Stop DVD program.
- SETUP**
DVD system setup.
- ◀◀ DVD fast reverse.
- ▶▶ DVD fast forward.
- ◀◀◀ DVD previous chapter.
- ▶▶▶ DVD next chapter.

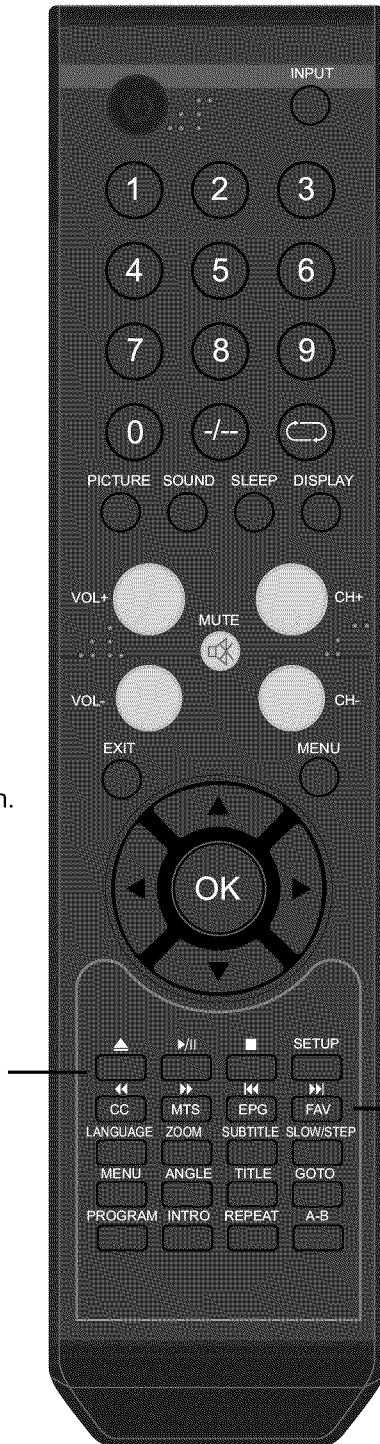

LANGUAGE

Select DVD disc language.

ZOOM

Adjust picture size in DVD mode.

SUBTITLE

Select DVD disc subtitle.

SLOW/STEP

Play DVD programs at slow speed.

MENU

DVD play list/Disc menu

ANGLE

Select DVD picture angle.

TITLE

DVD title.

GOTO

Play your favorite title/chapter/track.

PROGRAM

Select DVD picture angle.

INTRO

If you play CD, it will scan program with 3S.

REPEAT

Repeat playing the title or chapter.

A-B

Select and play the preferable paragraph of DVD program by pressing this key twice at the beginning and end of it.

Precautions

Avoiding Remote Control Problems

1. Check the polarity (+,-) of the batteries in the remote control.
2. Check that the batteries have power.
3. Check that the LCD TV is powered and that it is properly plugged in.
4. Check if any three-wavelength lamp, special fluorescent or neon sign is turned on near the LCD TV.

Inserting Batteries in the Remote Control

1. Open the cover completely.
2. Insert the two supplied batteries. Ensure that the polarities (+ and -) of the batteries are aligned correctly.
3. Slide back the cover.

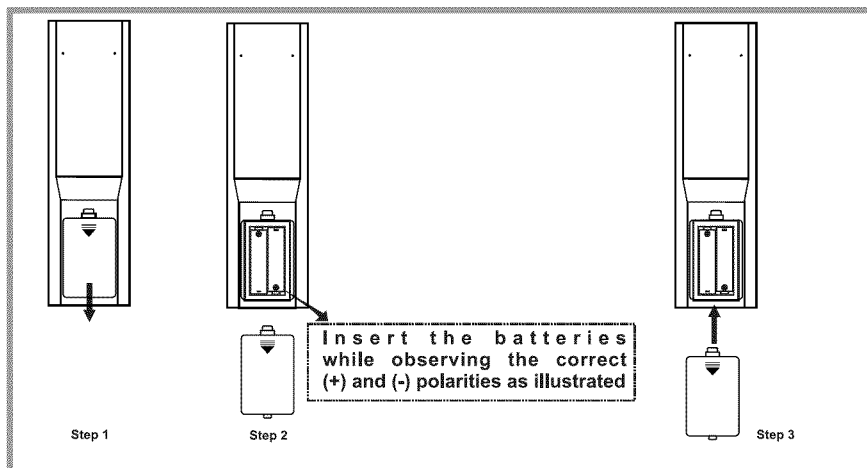



⚠ CAUTION : Risk of explosion if battery is replaced by an incorrect type.
Dispose of used batteries according to the national code (Recycling program).

How to use remote control

- The remote control should be operated within 30feet(7m) and 30° to the left and the right of the IR receiver at the front of the LCD TV.
- Used batteries should be disposed properly.

Powering the LCD TV

- Power on/ off

Press  on the bottom of the LCD TV to  first.

· To turn the LCD TV on :

Press "POWER" button on the LCD TV.

· To turn the LCD TV off :

Press "POWER" button on the LCD TV.

· To turn on/off by remote control :

Press the  button of remote control.

Selecting Input Source

- You can select between the TV signal and the input signal of other equipments connected to the TV.
- Use this function to switch to the input source you wish to view.

Press  button on the remote control.

Use  to move to the desired input source.

Press  to select.

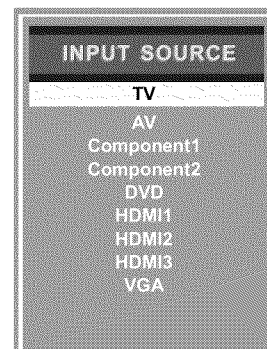

Basic OSD Menu operation

Press **MENU** button to display the OSD menu as below:

The screenshot shows the OSD menu interface. At the top, there are six main menu items: Picture, Audio, Time, Setup, Lock, and Channel. The 'Picture' menu is selected, showing a sub-menu with the following items: Picture Mode (Standard), Contrast (50), Brightness (50), Color (50), Tint (0), Sharpness (50), and Color Temp. (Normal). At the bottom of the menu, there are three control buttons: Select, Move, and Exit (with a MENU button icon).

Main menu
Picture, Audio, Time, Setup, Lock, Channel

Submenu
(Picture menu for example)

Hint
you should operate the OSD menu according to the hint.

Use < / > button to select the main menu, and press √ button to enter the submenu.

In the submenu, use ^ / v button to select the function item, and you could:

adjust ("Contrast" item in **Picture** menu for example) with < / > button;

select ("Picture Mode" item in **Picture** menu for example) with < / > button;

enter the submenu ("Close Caption" item in **Setup** menu for example) with > button.

* (Press MENU button to return to the upper menu.)

* (Press EXIT button to exit the menu display.)

Note1: Only when you input the suitable signal, the relevant items can be activated

Note2: Please operating the OSD menu according to hint on the bottom of the banner.

OSD Menu

1. Picture menu

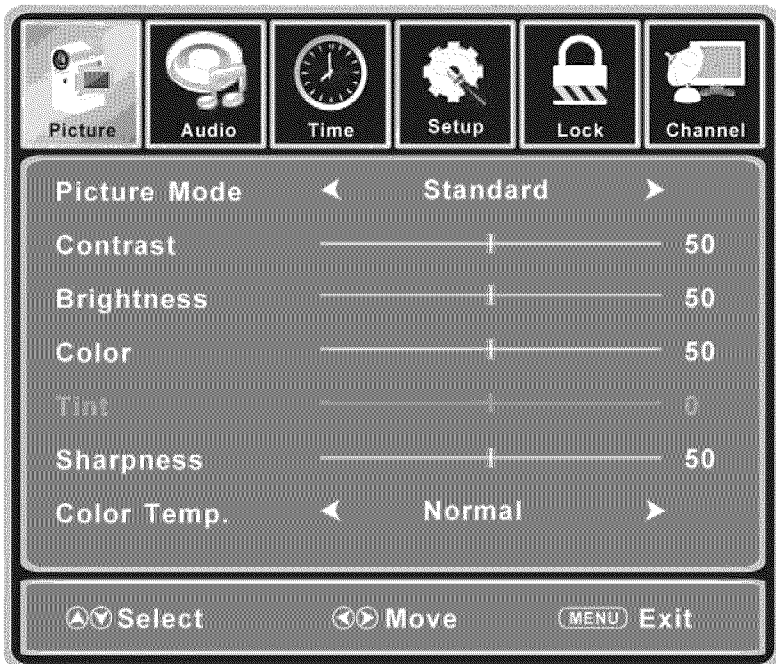

Description

Picture mode: Select between Standard, Dynamic, Mild, Sports and User.

You may select the picture mode directly by pressing the **PICTURE** button on the remote control.

Contrast: Control the difference between the bright and dark regions of the screen picture.

Brightness: Adjust brightness of the picture.

Color: Adjust color of the picture.

Tint: Control the fresh tones to make them appear natural.

Sharpness: Set the amount of fine detail in the picture.

Color Temp.: select between Normal, Cool and Warm.

2. Audio menu

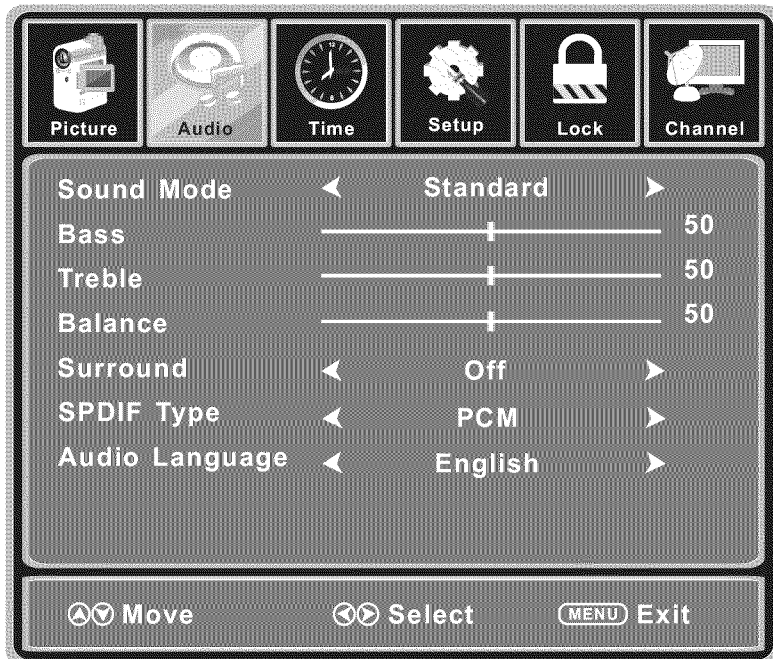

Description

Sound Mode: Select your desired picture mode as follow: Flat, Music, Movie, Sports and User
You may select the sound mode directly by pressing the **SOUND** button on the remote control.

Bass: Low frequencies intensity.

Treble: High frequencies intensity.

Balance: Left and right stereo audio channels balance.

Surround: Activate or deactivate the Surround function.

SPDIF Type: Allows you to select between PCM and RAW.

Audio Language: Select audio language.

3. Time menu



Description

Sleep timer: You may set the automatic shutdown timer choosing from 5 to 240 minutes, or deactivate this function.

Time zone: Select between Pacific, Alaska, Hawaii, Eastern, Central and Mountain.

Daylight Saving Time: Select between On and Off.

Clock: Modify date and time.

4. Setup menu

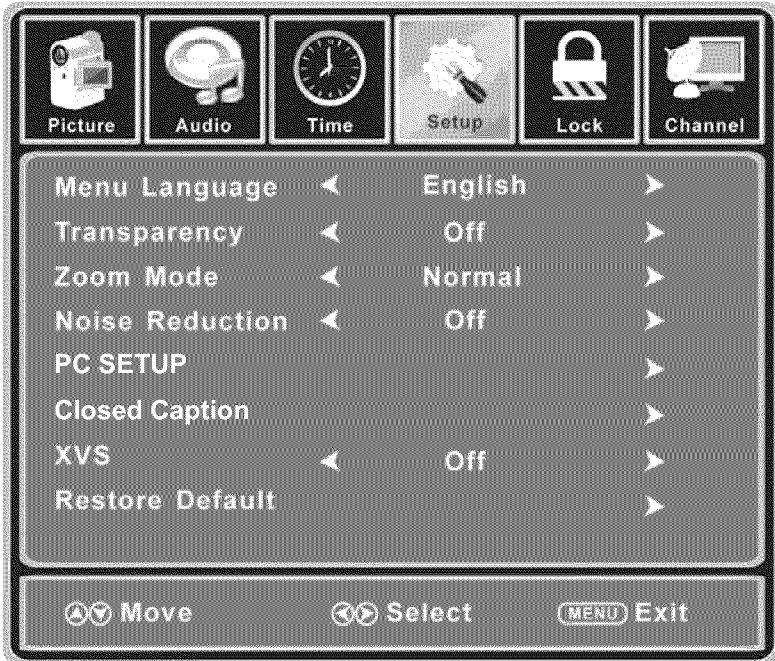

Description

Menu Language: Select OSD menu language.

Transparency: Turn on or off the transparency menu function.

Zoom Mode: Select the zoom mode between 16:9, 16:9 zoom, 4:3, 4:3 zoom.

Noise reduction: Select the noise reduction mode between Strong, Off, Weak and Middle.

PC SETUP: If the video input signal comes from your PC, you may adjust the V-Position, H-Position, Frequency, Phase or even perform an Auto adjustment.

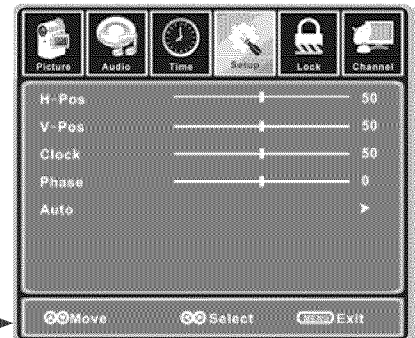

Closed Caption:

CC Mode: Allow you to select the CC Mode among: On, Off and CC on Mute.

Basic Selection: Allow you to select the basic selection among: CC1, CC2, CC3, CC4, Text1, Text2, Text3 and Text4.

Advanced Selection: Allow you to select the advanced selection among: Service1, Service2, Service3 Service4, Service 5 and Service 6.

Option: Use thumbstick buttons to operating in option menu as your desire.

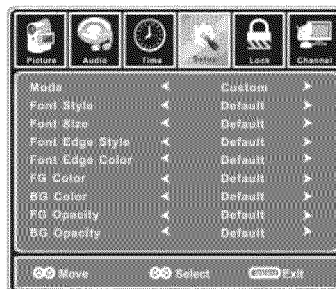

XVS: Activate / deactivate the automatic dynamic brightness function.

Restore Default: Restore all settings in SETUP menu to factory settings.

5. Lock menu

You must enter the password to gain access to the Lock menu. The default password is 0000. You may modify the following options:

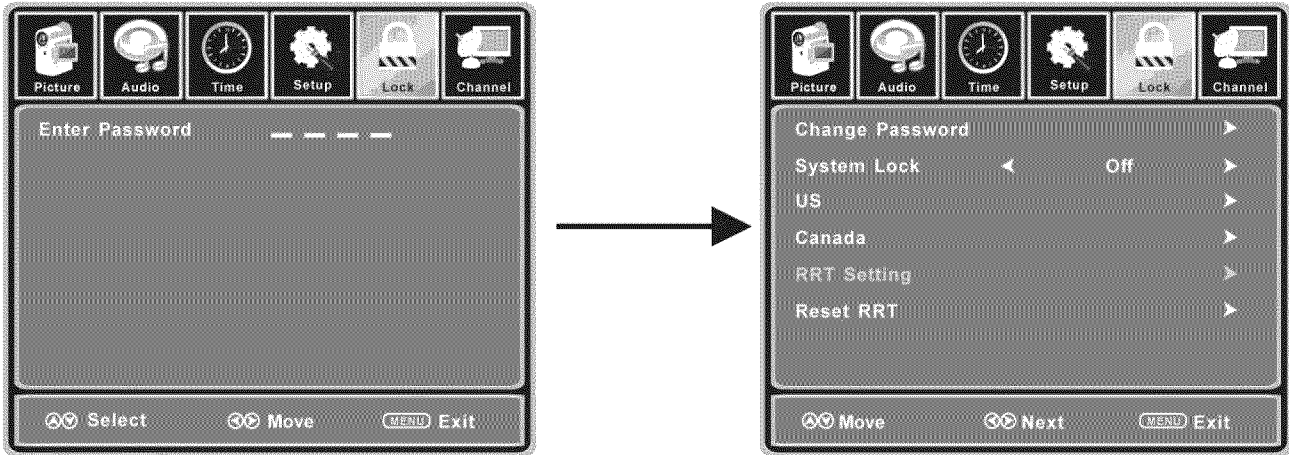

Description

Change password: Change the password, you must enter the new password twice to confirm it. Note: Do not forget the password.

Lock: Allow you to turn on or off the system lock. If deactivated, the functions described below don't work.

This option menu allows you to lock any TV channel or adjust the Movie rating filter.

US: _____ →

TV: Use \wedge / \vee buttons to select the desired rating and press $\>$ button to block or unblock rating.

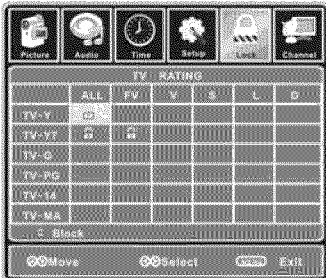

MPAA: The Movie rating (MPAA) is used for original movies rated by the Motion Picture Association of America (MPAA) as broadcasted on cable TV and not edited for television.

Use \wedge / \vee button to select N/A, G, PG, PG-13, R, NC-17 or X.

RATING	DESCRIPTION
G	General Audiences. Movie is appropriate for all ages.
PG	Parental Guidance Suggested. May contain material not suited for younger viewers.
PG-13	Contains content that may not be appropriate for viewers under the age of 13.
R	Restricted. Contains adult content, no one under 17 admitted without parent.
NC-17	No one 17 and under admitted.
X	Adults only.

Canada: _____ →

Canada English: Select among: E, C, C8+, G, PG, 14+ and 18+.

Canada French: Select among: E, G, 8ans+, 13ans+, 16ans+ and 18ans+.



Reset RRT: Allow you to reset the RRT setting.

6. Channel menu

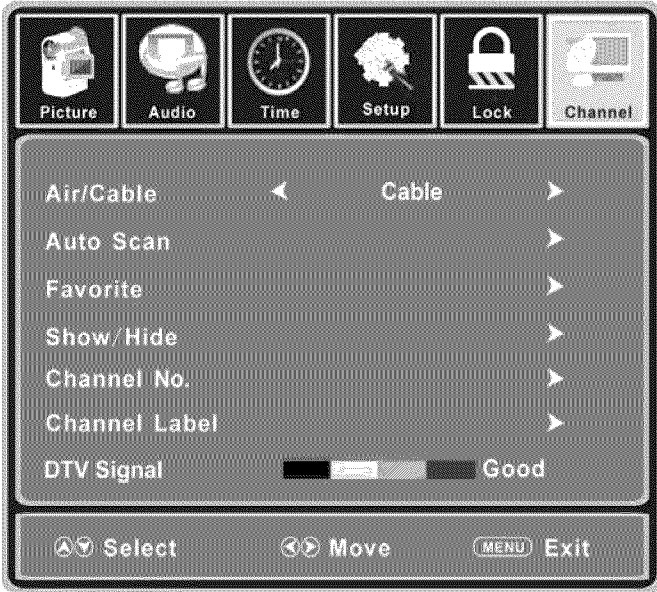

COLOR TV BROADCASTING SYSTEM

Country	Color System	Sound System
AZORES(PORTUGAL)	PAL	B/G
BALKANS(KOSOVO, BOSNIA)	PAL	B/G
BELGIUM/GERMANY/ITALY	PAL	B/G
IRAQ	SECAM	B
AFGHANISTAN	PAL	B
NETHERLANDS/NORWAY	PAL	B/G
SAUDI ARABIA	SECAM	B
	PAL	B
KUWAIT/TURKEY/JORDAN	PAL	B/G
UNITED KINGDOM	PAL	I
CZECH/HUNGARY/POLAND	PAL	D/K
RUSSIA	SECAM	D/K
U.S.A./JAPAN/KOREA/GUAM	NTSC	M

Description

Air/Cable: Allow you to select antenna between Air and Cable.

If you select "Cable", the following items(Favorite, Show/Hide, Channel NO, Channel Label and DTV Signal) are unable to use.

Auto Scan: Enter the Auto Scan menu to start auto scan.

- ★ If you select "Cable" as input signal in Antenna item, allows you to select Cable System among: Auto, STD, IRC and HRC. Use ∇ button to highlight the "Start to Scan", then press \rightarrow button to search the channels automatically. The receivable channels will be stored automatically. When searching channels, press **MENU** to stop.

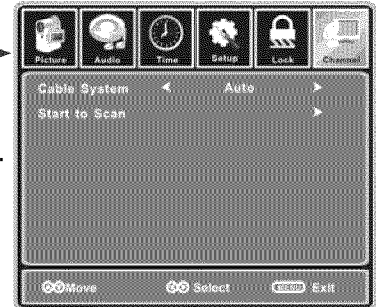

- ★ If you select "Air" as input signal in Antenna item, you can press \rightarrow button to search the channels automatically. The receivable channels will be stored automatically. When searching channels, press **MENU** to stop. NOTE: It will take a while to auto scan in NTSC or ATSC mode, please wait patiently.

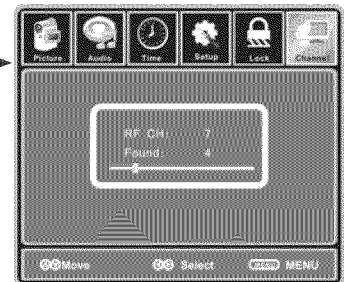

Favorite: Allow you to add these channels which you desired as the favorite channels.

Use \wedge / ∇ button to highlight the desired item, then press **OK** button to add or remove the highlighted channel as favorite.

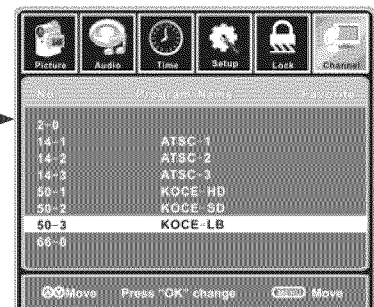

Show/Hide: Allow you to show or hide the channels.

Use \wedge / \vee button to highlight the desired item, then press **OK** button to show or hide the highlighted channel.

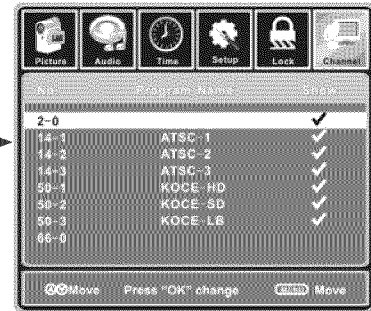

Channel No.: Show and select the channel.

Channel Label: Allow you to setup a label for the channel.

Press $<$ / $>$ button to select the position of the table, and press \wedge / \vee button to select the words.

DTV Signal: Show the quality of digital signal: good, Normal, Bad.

DVD Operation

Press the Power button on the TV or the remote control, then press the INPUT button to select DVD mode. If there is no disc in the DVD player the screen will show "NO DISC".

Place a disc

Insert Disc according to picture next to disc slot.

Do not touch the shining surface.

Hold the disc around the outside with your fingers and place the disc into the slot. The player will automatically draw the disc into the player.

To "Eject" the disc, press the **▲** button on the TV or the "**▲**" button on the remote control.

Play

The contents of each disc are vary, as to how the disc was authored and what features are included. Some discs start playing as soon as they have been read, some need "Play" selecting in the Menu. Different play modes are offered, such as Menu Play, Sequence Play and other modes.

Menu Play

1. Compatible with DVD, SVCD or VCD2.0.
2. If the disc is a DVD, ROOT MENU will appear on the screen. If it is SVCD or VCD 2.0, please press the Menu button to see the menu.
3. When a DVD disc is loaded, press the Arrows buttons to highlight the menu item you want to choose. With SVCD or VCD 2.0, press the numeric buttons to select a track to play.
4. Press OK or Play to start when highlighted.
5. Return to Menu when Playing: When playing a DVD disc press the Menu button to return to the "ROOT" menu. When playing a SVCD or VCD, and PBC is "on" press the Menu or Return button to return to the disc menu.

Title Play

1. Compatible with DVD discs only.
2. During DVD playback, press Title button to display the DVD title content.
3. Press the Arrow buttons to highlight the title you want to choose, and press OK; also you can press numeric buttons to choose.
4. The DVD player begins with the chapter 1 of the chosen title.

Sequence Play

1. Compatible with DVD, SVCD, VCD, CD, HD-CD, WMA, Digital Audio disc /JPEG discs.
2. When a SVCD or VCD disc is loaded and PCB is "on", press the MENU button once switches the PBC "off". The player can now playback in sequence mode. To turn the PBC back on press the MENU button again.
3. Except for SVCD or VCD discs, when in stop state, press the Play button, the player will play in the "Sequence" mode. This is for all compatible discs.

Program Play

1. Compatible with DVD, SVCD, VCD, CD, HD-CD, WMA, Digital Audio disc /JPEG discs.
2. The Program Playback option allows you to enter the order in which you want chapters or tracks to play, maximum to 16.
3. Program Menu: If PBC is on, this operation will turn PBC off while the chapters / tracks play in programmed order.
4. According to the highlight, use the Numeric buttons to enter the chapters / tracks in the order you want them to play. Then press Play or use Arrow buttons to highlight the "PLAY" item and press OK. The chapters /tracks will play in the programmed order. You can program maximum 16 titles / chapters / tracks.

DVD Operation

5. According to the Direction Indicator on the menu, you can press Arrow buttons to highlight where you want to enter.
6. During Program Playback, if program button is repressed, the program order and the contents will be displayed on the screen, and the Program Playback will be stopped; also you can press Stop and Play to resume normal playback.
7. Notes:
 - To clear the program order, use Arrow buttons to highlight the "CLEAR" item, then press OK.
 - To modify the program order, use Arrow buttons to highlight the item you are changing and enter the new chapter / track you want to program directly.
8. The program indicator in the screen and the playing chapter / track illuminate.

Additional operation

Selecting Tracks

1. Compatible with DVD, SVCD, VCD, CD, HD-CD, WMA, Digital Audio disc /JPEG discs.
2. When playing a DVD disc, press Numeric buttons on the menu or title page to select tracks; During DVD playback, you can input desired title numbers directly.
3. During sequence playback of a SVCD or VCD disk, press the numeric buttons to select tracks. (During Program Playback and when the PBC is on, you can only press Prev / Next button to select)
4. As for CD, HD-CD, discs, press Numeric buttons directly to select tracks.
5. When playing WMA, Digital Audio disc/JPEG discs, press Numeric buttons to select different tracks on current track list.

Skipping Tracks

1. Compatible with DVD, SVCD, VCD, CD, HD-CD, WMA, Digital Audio disc /JPEG discs.
2. To skip forward to the beginning of the next title / chapter / track on a disc, press Next on the remote or the right side of the player.
3. To skip backward to the beginning of the preceding title / chapter/track on a disc, press Prev on the remote or the right side of the player.

Multispeed Fast/Slow Motion Play

1. Compatible with DVD, SVCD, VCD, CD, HD-CD, WMA, Digital Audio disc /JPEG discs.
2. Press the Multispeed Fast/Slow button on the remote during play to search through a disc. Multispeed Fast/Slow has four speeds: x2, x4, x8, x20.
With each consecutive press of the button, the search speed increases. If you press the button five times, Fast Multispeed Fast/Slow cycles back to normal play.
3. During DVD play, when Multispeed Fast/Slow gets to the beginning of the next title / chapter, it resumes normal play; During SVCD or VCD play with PBC on, when Fast Forward Play gets to the beginning of the next track, it resumes normal play.

Multiphase Slow Motion Play

1. Compatible with DVD, SVCD, VCD, CD, HD-CD, WMA, Digital Audio disc/JPEG discs.
2. Multiphase Slow has six speeds: 1/2, 1/3, 1/4, 1/5, 1/6, 1/7 of the normal Speed play when pressing the "Slow" button consecutively when playing discs.
3. When you press Play or the "Slow" button 7 times the player returns to normal play.

Freeze Frame

1. Compatible with DVD, SVCD, VCD, CD, HD-CD, WMA, Digital Audio disc/JPEG discs.
2. During CD, HD-CD, WMA or Digital Audio disc / JPEG playback, press Pause once to freeze playback; Press Play button to resume normal playback.

Using the Repeat Feature

1. Compatible with DVD, SVCD, VCD, CD, HD-CD, WMA, Digital Audio disc /JPEG discs.

DVD Operation

2. While a disc is playing, press Repeat button once and the repeat banner appears to show current repeat mode.
 - a) In SVCD, VCD, CD, HD-CD, WMA or Digital Audio disc/JPEG sequence playback mode. Press Repeat button again to turn on repeat mode. Press the button again on the remote to turn to the next repeat mode. There are three repeat options: Off, Track Repeat and Disc Repeat. With each consecutive press of the button, the repeat mode switches. If you press the button four times, repeat mode cycles back to Off.
 - b) In DVD playback, press Repeat button again to turn on repeat mode. There are three repeat options: Off, Chapter Repeat and Title Repeat. With each consecutive press of the button, the repeat mode switches. If you press the button four times, repeat mode cycles back to Off.
 - c) In WMA, Digital Audio disc /JPEG playback, press Repeat button again to turn on repeat mode. There are four repeat options: Off, Track Repeat, Directory Repeat, and Disc Repeat. With each consecutive press of the button, the repeat mode switches. If you press the button five times, repeat mode cycles back to Off.

Using the Display Feature

1. Compatible with DVD, SVCD, VCD, CD, HD-CD, WMA, Digital Audio disc discs.
2. Loading and playing DVDs (two pages)
 - Press DISPLAY button once to show the first page:
 - "Disc Type, Title * / * (the playing title / total titles), Chapter * / * (the playing chapter / total chapters), Elapsed Time of the Disc".
 - Press the button again to show the second page:
 - "Language */* (the serial number of playing language / the amount of optional languages) or Off, Language Type, Audio Type, Subtitle * / * (the serial number of playing subtitle /the amount of optional subtitles) or Off, Angle * / * (the serial number of playing angle / the amount of optional angles) or Off".
 - Press the button for the third time, the display menu will disappear.
3. Loading and playing SVCD discs (two pages)
 - Press Display button once to show the first page:
 - "Disc Type, Track * / * (the playing track / total tracks), Mute, PBC, Repeat Mode, Elapsed Time of the Playing Track".
 - Press the button again to show the second page:
 - "Language * / * (the serial number of playing language/ the amount of optional languages) or Off, Language Type, Audio Type, Subtitle * / * (the serial number of playing subtitle / the amount of optional subtitles) or Off".
 - Press the button for the third time, the display menu will disappear.
4. Loading and playing VCD
 - Press Display button once to show the first page:
 - "Disc Type, Track * / * (the playing track / total tracks), Mute, PBC, Repeat Mode, Elapsed Time of the Playing Track".
 - Press the button again, the display menu will disappear.
5. Loading and playing CD, HD-CD, WMA, Digital Audio / JPEG discs
 - Press Display button once to show the first page:
 - "Disc Type, Track * / * (the playing track / total tracks), Mute, Repeat Mode, Elapsed Time of the Playing Track".
 - Press the button again, the display menu will disappear.

Using the Search Feature

1. Compatible with DVD, SVCD, VCD, CD, HD-CD discs.
2. You can use Search feature to select a title/ chapter/track number or go to a specific point in a title. First, press GOTO button on the remote controller to bring up the search menu and enter the edit state. Secondly, press Arrow buttons to highlight the title / chapter/ track number or the time option; Thirdly, use Numeric buttons to enter the title / chapter/ track you want to play or the elapsed time you want to go to in that title. At last, press OK button to start playback. For example, entering 01:23:56 will start playback form one hour, twenty-three minutes and fifty-six seconds into the title.

3. Notes

- a) This feature does not work in Program Play mode.
- b) If PBC is on, it will turn off automatically when Search Playback starts.
- c) When playing WMA, MP3 / JPEG discs, Search Feature does not work.

Changing the Soundtrack or Language

1. Compatible with DVD SVCD, VCD, CD, HD-CD, WMA, Digital Audio disc /JPEG discs.
2. Press the LANGUAGE button to display current soundtrack.
 - a) Press the button to switch soundtracks.
 - b) Press the button again on the remote to turn to next soundtrack.
3. When playing a SVCD or VCD disc, there are five soundtracks: Stereo (L/R), L/L, R/R, L/L Auto A/D Detect, and R/R Auto A/D Detect. With each consecutive press of the button, the soundtrack switches. If you press the button six times, soundtrack cycles back to Stereo.
4. When playing a CD, HD-CD, WMA, Digital Audio disc, there are three mode: Stereo (L/R), L/L, and R/R.
5. When playing a DVD or SVCD disc, press LANGUAGE button to display current language, press the button again to turn to next language if the disc has different languages.

Subtitles

1. Compatible with DVD, SVCD discs.
2. Press the Subtitle button on the remote once, and the subtitle info banner appears
3. When a DVD or SVCD is recorded with subtitles, you can use the Subtitle feature to view the subtitles on-screen. By default, subtitles are off. The info banner will display Subtitle Off.
4. To display subtitles, press the Subtitle button again. The default language with its responding serial number will be displayed in the info banner and subtitles will be displayed in that language. With each consecutive press of the Subtitle button, the subtitle switches. For example, "Language Icon: [1 English DTS 6CH] or [Off]" (the availability of the subtitles are disc-support). To turn subtitles off, press the Subtitle button until Subtitle Off is displayed.

Mute the Audio Output

1. Compatible with DVD, SVCD, VCD, CD, HD-CD, WMA, Digital Audio disc /JPEG discs.
2. Pressing the Mute button allows you to reduce sound to an inaudible level, and the icon of "MUTE" will be displayed on screen. Press the button again or press the Vol +/- button to return to the normal condition.
3. If the player has no sound, check that the "Mute" is not on.

Zoom In the Video Image

1. Compatible with DVD, SVCD, VCD, JPEG discs.
2. The Zoom Function allows you to adjust the size of video image.
3. Press Zoom repeatedly to activate the function and choose the required zoom factor: Zoom 2, Zoom 3, Zoom 4, Zoom 1/2, Zoom 1/3, Zoom 1/4, Zoom Off.

Repeat a Specific Segment on the Disc that You Define

1. Compatible with DVD, SVCD, VCD, CD, HD-CD, WMA, Digital Audio disc.
2. During normal or fast playback, press the A-B button once. REPEAT "A" appears on the screen. This indicates the starting point of the loop.
3. Press A-B again, REPEAT A-B will be shown, this indicates the end point of the loop.
4. The segment will now be repeated until you press the "REPEAT" button again to turn off the feature.
5. Press A-B again to cancel the loop points.
6. When playing a SVCD, VCD, or CD disc, you can repeat a specific segment only in one track. When the next track begins, A-B Repeat turns off automatically.
7. When playing a DVD disc, you can repeat a specific segment only in one title.

Digital Audio Disc

1. Compatible with Digital Audio discs
2. The player will search the disc directory automatically and display the contents on screen.

DVD Operation

3. The player will then start to play the first track, of the selected directory.
4. To change directories use the direction buttons.

DVD System Operation

System operation will define the setting of the set; these definitions will be stored until you change them again.

General Steps of Setup Menu

1. Pause or Stop the player. Press **DVD-SETUP** on the remote control. The main menu will be shown as below.

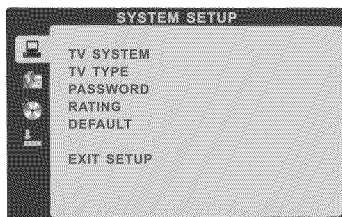

2. Press the \uparrow/\downarrow buttons to select the Icon of the desired section, e.g. "TV System" and press \Rightarrow button to open that section.
3. Press \uparrow/\downarrow to select the desired feature and again press \Rightarrow button to open that section.
4. Press \uparrow/\downarrow to select the desired feature and then press **"OK"** to select the new setting.
- 5 To exit the menu, press **"DVD-SETUP"** or \downarrow to select EXIT SETUP and then press **"OK"**

When launching the setup routine, the pressing of the following buttons will turn off the setup menu, while the choices that have been changed will be saved.

Menu specification

1. SYSTEM SETUP

The system setup options are illustrated below:

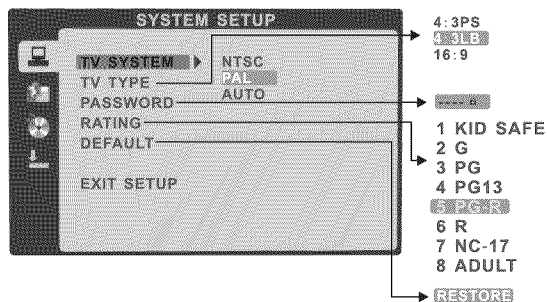

To view pictures on a slid show, open the folder where pictures are and press \blacktriangleright button.

Note: Do not press $\blacktriangleright\parallel$ button after open a picture.

TV SYSTEM

According to the Color system of your TV, select proper TV TYPE.

PASSWORD

The password option is initialized as locked. You cannot set the ratings limit or change the password.

To enable these features you must unlock the Password. The default password is "0000". Using the \uparrow/\downarrow button, move the highlight to "PASSWORD", press the \Rightarrow button and enter "0000". You will see the padlock symbol open. You may now change the RATING or put in a new password number.

If the Lock symbol is BLUE you must press the \Rightarrow button to enter the lock field, the lock symbol will change to YELLOW, you may now enter a new 4 digit number. Please remember or write down the new Password and keep safe.

RATING

The Rating feature is a rating limit feature, like movie ratings. This helps you to control what DVD the family watches. There are 8 levels of selection, from KIDS SAFE to ADULT. Adult is the "play all" selection.

2. LANGUAGE SETUP

The language setup options are illustrated below:

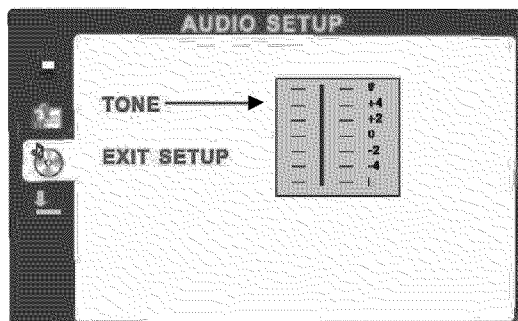

- OSD LANGUAGE: The OSD will display in the language you choose.
- AUDIO LANG: If the disc you are playing has the language you choose, it will output audio in that language.
- SUBTITLE LANG: If the disc you are playing has the language you require you may select this either in the Menu or using the "SUBTITLE" button on the Remote control. You may also switch this OFF.
- MENU LANG: If the disc you are playing has the language you require you may select this.

3. AUDIO SETUP

-TONE: Use the \uparrow/\downarrow button to move the scroll and adjust the tone.

4. DIGITAL SETUP

The video setup options are illustrated below:

- DYNAMIC RANGE: Use the \uparrow/\downarrow button to move the scroll and adjust the dynamic range.
- DUAL MONO: Choose the mode of the audio output.
- There are four modes: STEREO, MONO L, MONO R, MIX MONO.

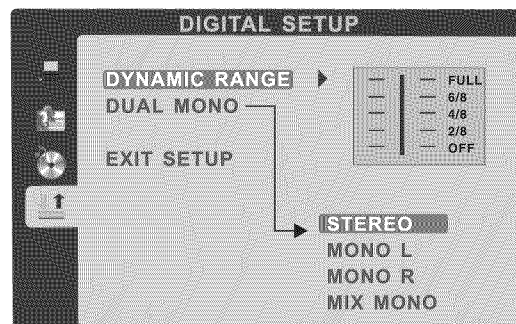

Disc Care

Disc Care

About Disc Terms

Title

Generally, pictures or music compressed on a DVD are divided into several sections, "title".

Chapter

The smaller section unit of picture or music in a DVD under the title, usually one title is comprised of one or more chapters and each of them is numbered for easy searching, but some discs may not have a recording chapter.

Track

A segment of picture or music on a CD, Each track is numbered for searching.

Care of Disc

Video disc contains high-density compressed data that needs proper handling.

1. Hold the disc with fingers by outer edge and/or the center spindle hole. Do not touch the discs surface.
2. Do not bend or press the disc.

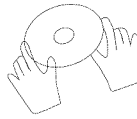

3. Do not expose the disc to direct sunlight or heating sources, Store discs in cabinet vertically, and in dry condition.

Prevent exposure to:

Direct sunlight

Heat or exhaust from a heating device

Extreme humidity

Clean the disc surface with a soft, dry cleaning cloth, Wipe the disc surface gently from center toward the outer edge.

Do not apply thinner, alcohol, chemical solvent, or sprays when cleaning. Such cleaning fluids will permanently damage the disc surface.

Trouble shooting

- Do not use other functions that are not mentioned in this user's manual.
- In case a problem occurs with your LCD TV, please take the following steps first.
- If you still have the problem, turn the power off and contact your dealer or an authorized service center.

Problem	Action
The screen does not appear.	Is the power plug pulled out? Insert the power plug. Press the power button of the remote control.
The screen appears too slowly after the power is turned on.	This problem occurs for a brief time in the process of image elimination processing in order to hide temporary screen noise that occurs when the power is turned on. But if the screen does not come after 1 minute contact your dealer or an authorized service center.
Screen is too bright or too dark.	Perform brightness adjustment or Contrast adjustment.
Screen is too large or too small.	Adjust the screen size.
Stripes appear on the screen and it shakes.	Stop using wireless telephones, hair driers and electric drills.
Screen appears, Voice is not heard	<ol style="list-style-type: none"> 1. Press the "MUTE" button. 2. Increase the sound level by pressing volume adjustment button. 3. Check if sound terminal of external input is connected properly. 4. Check if audio cables are connected properly. 5. Select and check the other input. <p>If the sound still does not work and the other channels are the same after you have done as the above, contact your dealer or an authorized service center.</p>
Remote control does not work	<ol style="list-style-type: none"> 1. Check if main power is On. 2. Check that the batteries of the remote controller were loaded properly. 3. Check to see if any obstacle exists between the LCD TV and the remote control, then remove it, if any. 4. If the batteries have no power, replace them with two new batteries.

- This LCD TV is for household use and registered as harmless on electromagnetic waves.
- Therefore, you can use it in every location as well as residential areas.

Specifications

LCD Panel	Panel Size	26" (measured diagonally) TFT LCD
	Brightness	450cd/m2
	Contrast Ratio	1000:1
BROADCAST SIGNAL SYSTEM		NTSC M + ATSC
ANTENNA INPUT IMPEDANCE		x1
SOUND OUTPUT		6W x2
Max. Resolution		1366 x 768
Input Connector	VIDEO	2
	S-VIDEO	1
	YPbPr	1
	AUDIO (L/R)	2
	PC IN	1
	HDMI	3
	RF	1
Output Connector	VIDEO	1
	AUDIO (L/R)	1
	SPDIF	1
Power Source	AC 100-240V, 50/60HZ	
Power Consumption	80W	

- The cabinet design and electronics specifications will be modified without prior notice for improving the performance.

VIORE™ LIMITED WARRANTY

FLAT PANEL TELEVISION

This **VIORE** brand Product, as supplied and distributed by **VIORE** and delivered new in the original carton to the original purchaser is warranted by **VIORE** against manufacturing defects in materials and workmanship for a limited warranty period of one (1) year on parts and labor. However, there will be only a 90 day parts and labor limited warranty for commercial use.

This Limited Warranty does not apply to store display products and product sold as a "marked down" special, in "as is" condition, "open box", products missing accessories, no fault found or damaged at time of delivery to **Viore**.

Proof of purchase within one year from date of purchase in the form of a Bill of Sale, Receipt or Receipted Invoice is evidence the Product is within the limited warranty period. The Bill of Sale, Receipt or Receipted Invoice must be presented as a pre-condition to obtaining the limited warranty service.

This limited warranty begins on the original date of purchase, and is valid only on Products purchased through **VIORE** authorized dealers and used in the United States by the original purchaser. To receive warranty service, the purchaser must contact **VIORE** for problem determination and service procedures. Warranty service may only be performed by a duly authorized **VIORE** service center. The original dated bill of sale, receipt or receipted invoice must be presented upon request as proof of purchase to **VIORE** or **VIORE's** authorized service center.

VIORE will repair or if repairs cannot be made, **VIORE** will replace this Product at no charge if the Product is defective as specified in this limited warranty during the limited warranty period. **VIORE** may use new, or remanufactured parts or products to repair or replace the Product at its sole discretion. All replaced parts and Products become the property of **VIORE** and must be returned to **VIORE**. Replacement parts and Products assume the remaining original limited warranty, or ninety (90) days, whichever is longer.

Product freight needs to be prepaid by original purchaser and shipped in either its original packaging or packaging affording an equal degree of protection. **VIORE** shall not be responsible for or obligated to replace damaged goods. If you reside in California and you cannot transport the television due to the size, weight, and method of attachment, **VIORE** will provide transportation for the television to the repair facility. If you reside in a state other than California, you are responsible for the costs of transporting the television to a repair facility.

If the product is received damaged by **VIORE**, it is the responsibility of the consumer to file a claim against the carrier. **VIORE** will only store the damaged product for 30 days and reserves the right, in its sole discretion, to dispose of the damaged product or ship it back to the consumer at consumer's expense after 30 days.

This limited warranty covers manufacturing defects in materials and workmanship encountered in normal, and except to the extent otherwise expressly provided for in this statement, noncommercial use of this product, and shall not apply to the following, including, but not limited to: damage which occurs in shipment; delivery and installation; applications and uses for which this product was not intended; altered product or serial numbers; cosmetic damage or exterior finish; accidents, abuse, neglect, fire, water, lightning or other acts of nature; use of products, equipment, systems, utilities, services, parts, supplies, accessories, applications, installations, repairs, external wiring or connectors not supplied or authorized by **VIORE** which damage this product or result in service problems; incorrect electrical line voltage, fluctuations and surges; customer adjustments and failure to follow operating instructions, cleaning, maintenance and environmental instructions that are covered and prescribed in the instruction book; reception problems and distortion related to noise, echo, interference or other signal transmission and delivery problems; burned-in images. **VIORE** does not warrant uninterrupted or error-free operation of the product.

THERE ARE NO EXPRESS WARRANTIES OTHER THAN THOSE LISTED AND DESCRIBED ABOVE, AND NO WARRANTIES WHETHER EXPRESS OR IMPLIED, INCLUDING, BUT NOT LIMITED TO, ANY IMPLIED WARRANTIES OF MERCHANTABILITY OR FITNESS FOR A PARTICULAR PURPOSE, SHALL APPLY AFTER THE EXPRESS WARRANTY PERIODS STATED ABOVE, AND NO OTHER EXPRESS WARRANTY OR GUARANTY GIVEN BY ANY PERSON, FIRM OR CORPORATION WITH RESPECT TO THIS PRODUCT SHALL BE BINDING ON VIORE. REPAIR OR REPLACEMENT AS PROVIDED UNDER THIS LIMITED WARRANTY IS THE EXCLUSIVE REMEDY OF THE CONSUMER. VIORE SHALL NOT BE LIABLE FOR ANY INCIDENTAL, OR CONSEQUENTIAL DAMAGES FOR BREACH OF ANY EXPRESS OR IMPLIED WARRANTY ON THIS PRODUCT; EXCEPT TO THE EXTENT PROHIBITED BY APPLICABLE LAW, ANY IMPLIED WARRANTY OF MERCHANTABILITY OR FITNESS FOR A PARTICULAR PURPOSE ON THIS PRODUCT IS LIMITED IN DURATION TO THE DURATION OF THIS LIMITED WARRANTY. THIS LIMITED WARRANTY SHALL NOT EXTEND TO ANYONE OTHER THAN THE ORIGINAL PURCHASER OF THIS PRODUCT, IS NONTRANSFERABLE AND STATES YOUR EXCLUSIVE REMEDY.

Some states do not allow limitations on how long an implied warranty lasts, or the exclusion or limitation of incidental or consequential damages, so the above limitations or exclusions may not apply to you. This warranty gives you specific legal rights, and you may also have other rights which vary from state to state. Any provision contained herein which is found contrary to state or local laws shall be deemed null and void and the remaining provisions shall continue in full force and effect.

To obtain warranty service, please contact **VIORE** at:

Phone: 1-877-777-1428
www.viore.com

