



# ASSEMBLY INSTRUCTIONS

## INSTRUCCIONES DE ARMADO



Do Not Return This Product To The Store  
Toll Free: 877-885-1635  
[www.medalsports.com.tw](http://www.medalsports.com.tw)

No devuelva este producto a su local de venta  
Número telefónico gratis: 877-885-1635  
[www.medalsports.com.tw](http://www.medalsports.com.tw)

MODEL/MODELO: 54804

## **LIMITED 90 DAYS WARRANTY**

This product is covered by a limited warranty that is effective for 90 days from the date of purchase. The warranty covers any defects in parts and workmanship.

If, during the limited warranty period, a part is found to be defective or breaks, we will offer either a free repair or replacement part at no cost to you, the customer. The only exceptions to the warranty include main frames, table tops, playing surfaces, batteries, tools. The above warranty will not apply in cases of damages due to improper usage, alteration, mis-use, abuse, accidental damage or neglect.

A PURCHASE RECEIPT (or other proof of purchase date) will be required before any warranty service is initiated. All requests for warranty service can be submitted by email, in writing or by contacting our Consumer Service Dept. at:

**Toll Free: 877-885-1635**

**Email: [tablegame@medalsports.com.tw](mailto:tablegame@medalsports.com.tw)**

**Website: [www.medalsports.com.tw](http://www.medalsports.com.tw)**

This Limited Warranty gives you specific legal rights and you may also have other rights which vary from one state (province) to another.

**PLEASE SAVE THESE INSTRUCTIONS  
AND PURCHASE RECEIPT!  
DO NOT RETURN THIS PRODUCT TO THE STORE!**

## **IMPORTANT NOTICE! Do Not Return This Product To The Store.**

Please Keep Your Instructions! Your Model number is necessary should you need to contact us. Please read through this instruction manual book to familiarize yourself with all parts and assembly steps. kindly refer to the parts identifier below and be sure that all parts have been included.

Although we are dedicated to giving our customers the best product possible, a question may arise or parts may be missing. If you are missing parts, or, if you have any questions, please contact our fast and friendly service centre on : **877-885-1635**

## **TOOLS REQUIRED:**

Phillips Screwdriver – **Not Included**

Standard (Flat Head Screwdriver) – **Not Included**

Allen Wrench - **Included**

Electric Screwdrivers may be helpful during assembly; however, please set a low torque and use extreme caution because screws may be high. stripped or over-tightened if the electric screwdriver's torque is set too high.

## **ASSEMBLY TIPS:**

1- When installing parts that have more than one bolt, hand tighten all bolts before tightening individual bolts with a screwdriver or allen key.

2- Some figures or drawings may not look exactly like your product. Please read and understand the text before beginning each assembly step.

## **NOTICE!**

READ AND FOLLOW ALL ASSEMBLY, OPERATION, AND SAFETY INSTRUCTIONS CAREFULLY. AT LEAST TWO ADULTS ARE NEEDED FOR THE ASSEMBLY OF THIS TABLE.

THIS IS NOT A CHILD' S TOY. ADULT SUPERVISION IS REQUIRED FOR CHILDREN PLAYING THIS GAME. PLEASE READ INSTRUCTIONS CAREFULLY. PROPER USE OF THIS SET CAN AVOID DAMAGE OR INJURY.













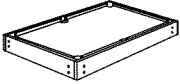
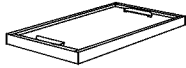



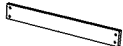

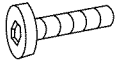
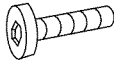































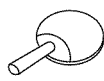

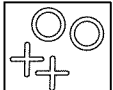
**WARNING:** Adult Assembly Required.



**WARNING:**

CHOKING HAZARD - - This item contains small parts and small balls.  
Not suitable for children under 3 years.

# PARTS IDENTIFIER

#1  Billiard Cabinet 1 Piece	#2  Hockey Table With Table Tennis 1 Piece	#3  Backgammon With Bowling Board 1 Piece	#4  Left Leg 2 Pieces	#5  Right Leg 2 Pieces	#6  Leg Side Panel 2 Pieces
#7  Basketball Board 1 Piece	#8  5/16" *1" Bolt 16 Pieces	#9  1/4" *1-1/8" Bolt 4 Pieces	#10  4*12mm Bolt 4 Pieces	#11  5/16" Butterfly Bolt 4 Pieces	#12  1/4" Hex Nut 4 Pieces
#13  4mm Lock Nut 4 Pieces	#14  Plastic Screw 8 Pieces	#15  F3*1/2" Screw 12 Pieces	#16  P3.5*8mm Screw 4 Pieces	#17  4*10mm Screw 8 Pieces	#18  4*15mm Screw 16 Pieces
#19  Crooked Pole 2 Pieces	#20  Short Pole 2 Pieces	#21  Side Pocket 2 Pieces	#22  Corner Pocket 4 Pieces	#23  Corner Basket 4 Pieces	#24  Side Basket 2 Pieces
#25  Rivet Plug 2 Pieces	#26  8mm Leg Leveler 4 Pieces	#27  Plastic Leg Base 4 Pieces	#28  Rod Cap 2 Pieces	#29  Basketball Net 1 Piece	#30  Rim 1 Piece
#31  Basketball Return Net 1 Piece	#32  Allen key 1 Piece	#33  Hockey Pusher 2 Pieces	#34  Felt Pad 2 Pieces	#35  Hockey Puck 2 Pieces	#36  Chalk 2 Pieces
#37  1.5" Pool Balls 1 Set	#38  1.5" Triangle 1 Piece	#39  36" Cues 2 Pieces	#40  Table tennis net with post 1 Set	#41  Table-tennis Ball 2 Pieces	#42  Table Tennis Bat 2 Pieces
#43  Bowling Pin 1 Set	#44  Bowling 1 Piece	#45  Tic-Tac-Toe 1 Set	#46  Bean Bag 4 Pieces	#47  Baseball 1 Piece	#48  Football 1 Piece
#49  Chess Set 1 Set	#50  Backgammon & Checker Set 1 Set	#51  Dice Box 1 Piece	#52  Dice 5 Pieces	#53  Basketball 1 Piece	#54  Air Pump 1 Piece

# ASSEMBLY INSTRUCTIONS

1. Find a clean, level place to begin the assembly of your Combo table. The table will be assembled upside down and then turned over on its legs once the assembly completed. This game table is heavy, and tuning it over will require at least two strong adults.
2. Remove all the parts from the box and verify that you have all of the listed parts as shown on the parts identifier below. Carefully cut or tear the four corners of the box so that the bottom of the box can be used as your work surface.

## FIG.1 POCKET ASSEMBLY

3. Attach the Side Pocket (#21) to the bottom of Billiard Cabinet (#1) using four Screws (#17) per Side Pocket. **See FIG.1.**
4. Attach the Corner Pocket (#22) to the bottom of Billiard Cabinet (#1) using two Screws (#18) per Corner Pocket. **See FIG.1.**
5. Repeat the steps above for the other pockets.

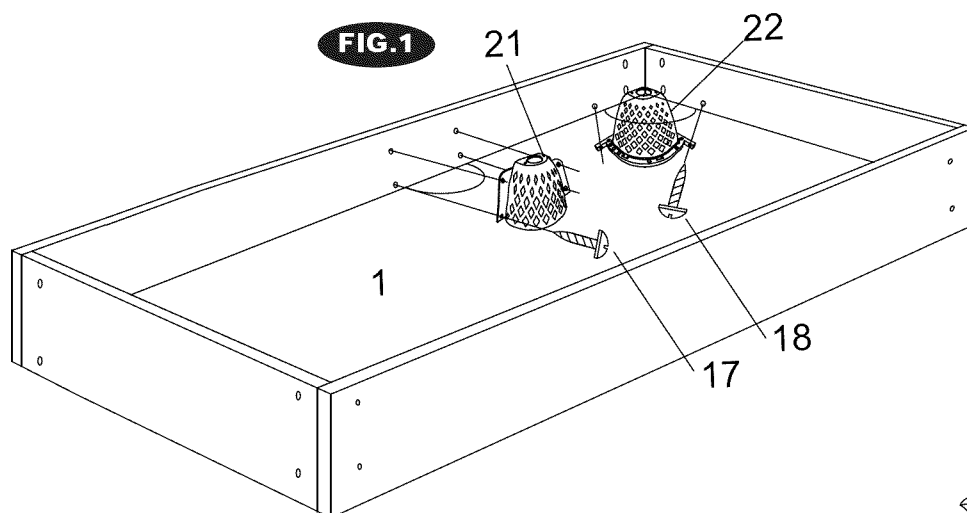

## FIG.2 LEG ASSEMBLY

6. Attach the Plastic Leg Base (#27) to bottom of the Left (#4) and Right(#5) Leg using two Plastic Screws (#14) per Leg Base. **See FIG.2.**
7. Next, screw the Leg Leveler (#26) into the top of the Leg Base (#27). **See FIG.2.**

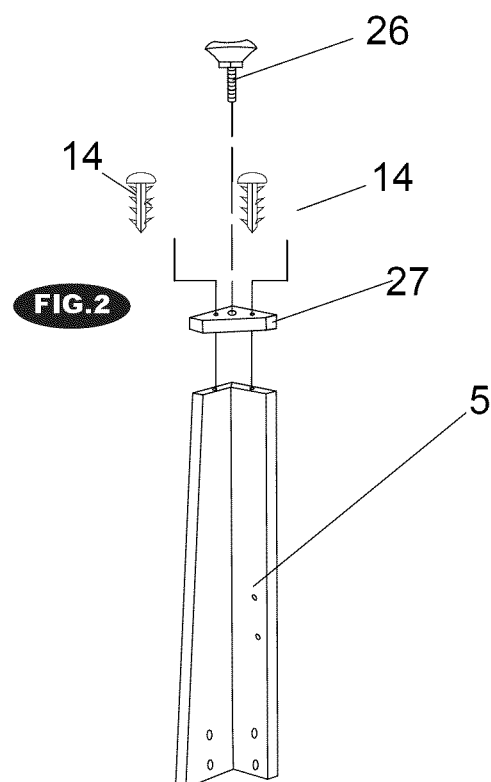

## FIG.3 BILLIARD TABLE ASSEMBLY

8. Attach the previously-assembled Legs (#4 and #5) to the end of Billiard Cabinet(#1) using four Bolts (#8) *See FIG.3.*

9. Attach the Leg Side Panel (#6) between the inside of Left and Right Legs using four Screws (#18) per Leg Side Panel. *See FIG.3.*

**FIG.3**

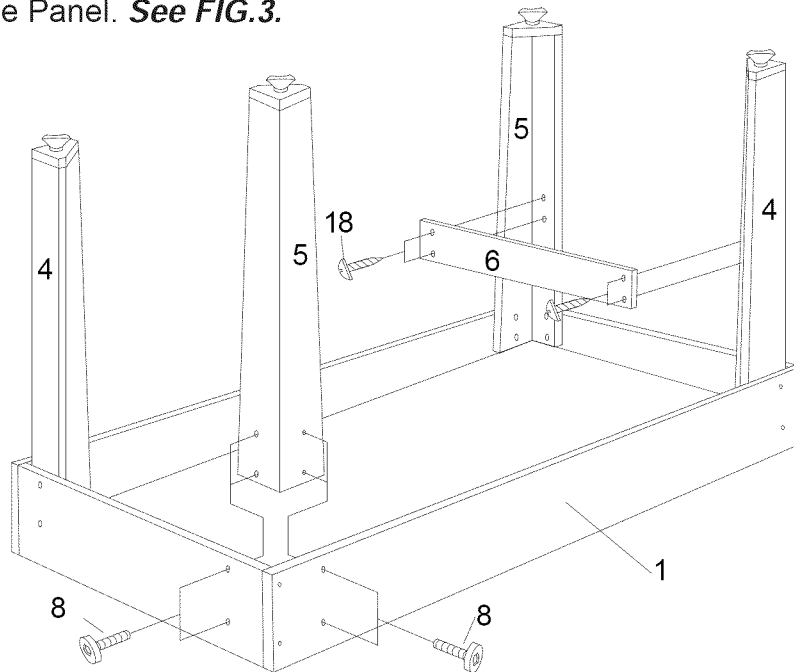

10. Lift the table assembly from the floor with two strong adults, turn it over, and set table on its legs in the location where you play. Go back and make sure that all connections are tight.

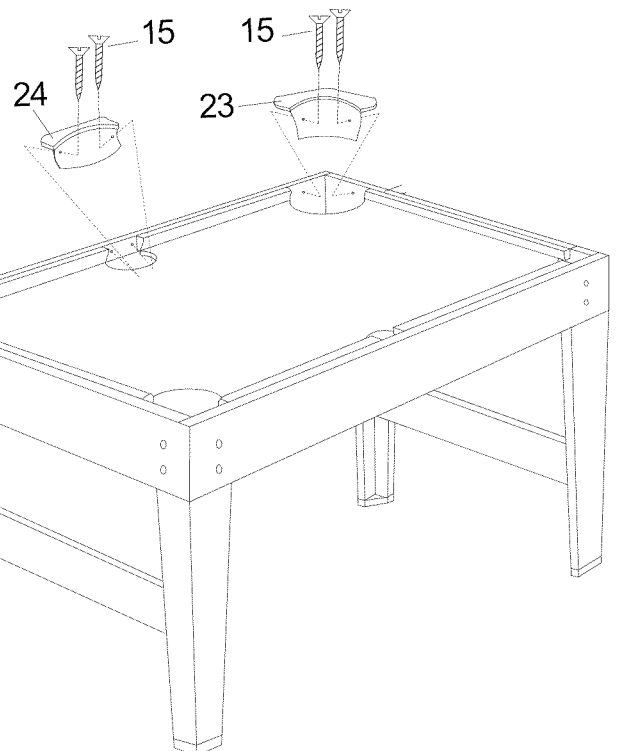

## FIG.4 BASKET OF BILLIARD TABLE ASSEMBLY

11. Attach the Corner Basket (#23) and Side Basket (#24) to Billiard Cabinet (#1) using two Screws (#15) per Basket. *See FIG.4*

**CAUTION:** Two strong adults are recommended to turn the table over as shown.

1. Lift the table off the ground.
2. Turn the table over.
3. Place it on all four feet at the same time on the ground.

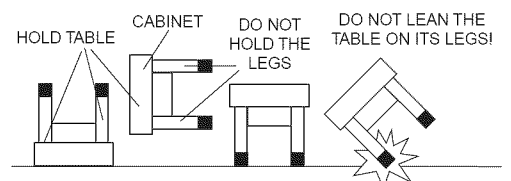

## FIG.5 BASKETBALL ASSEMBLY

12. Attach the Crooked Pole (#19) to the end of Billiard Table using two Butterfly Bolts (#11) per Crooked Pole. *See FIG.5A.*
13. Attach the Rim (#30) to the Basketball Board (#7) using four Bolts (#10) and four Nuts (#13). *See FIG. 5B.*
14. Attach the Short Pole (#20) to the back of the Basketball Board (#7) using four Bolts (#9) and four Nuts (#12). And then install the Rod Cap (#28) on the top of the Short Pole (#20). *See FIG.5C.*

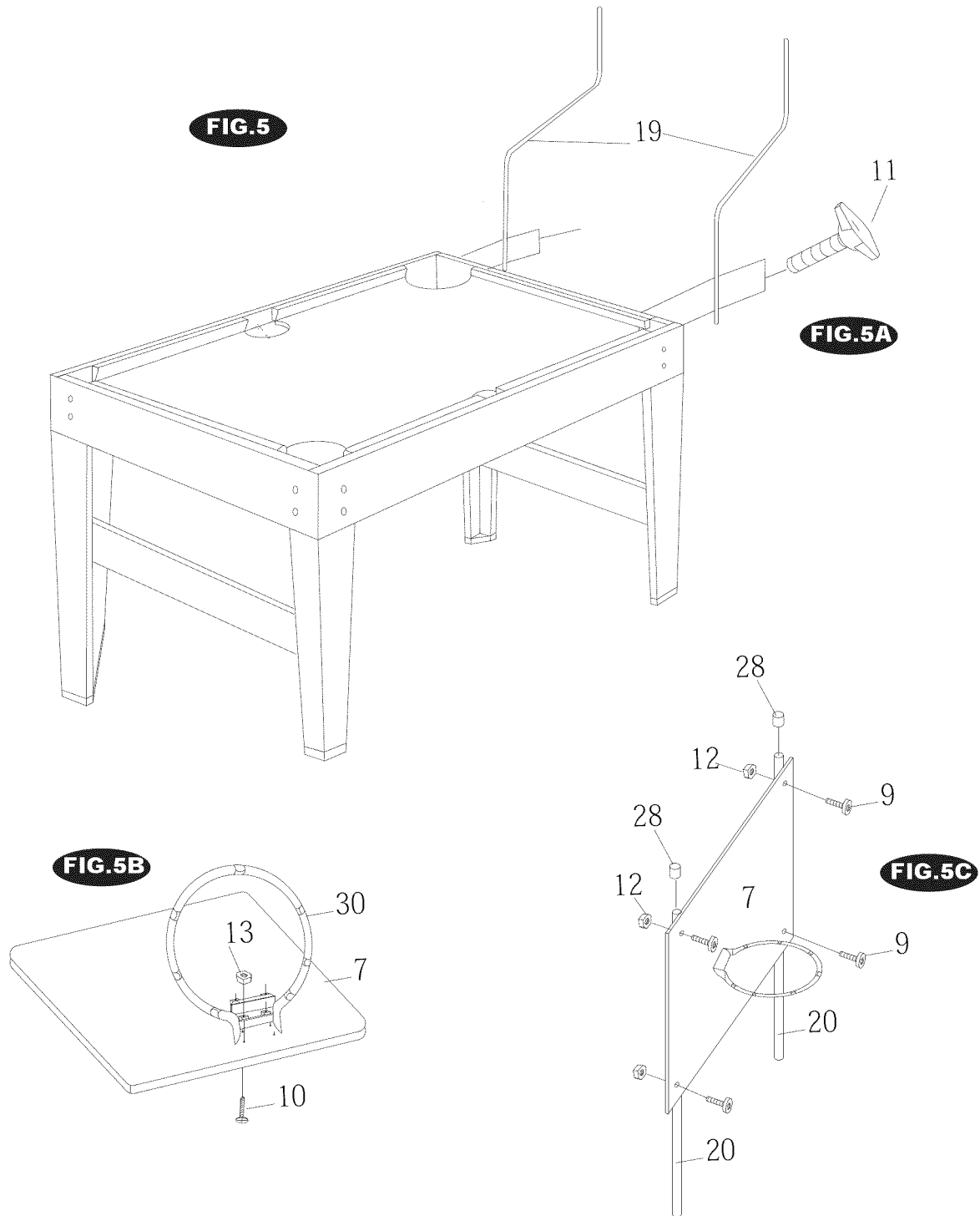

15. Attach the previously-assembled Basketball Board (#7) to the Crooked Pole (#19) using two Screws (#16) per side. **See FIG.5D.**

16. Attach the Basketball Net (#29) to the Rim (#30) by slipping the top of the Net over the Rim hooks. **See FIG.5E.**

17. Attach the Basketball Return Net (#31) to the Short Pole (#20) using the Velcro strips. Secure the bottom of it to the Billiard Table using two Rivet Plugs (#25). **See FIG.5F**

**FIG.5D**

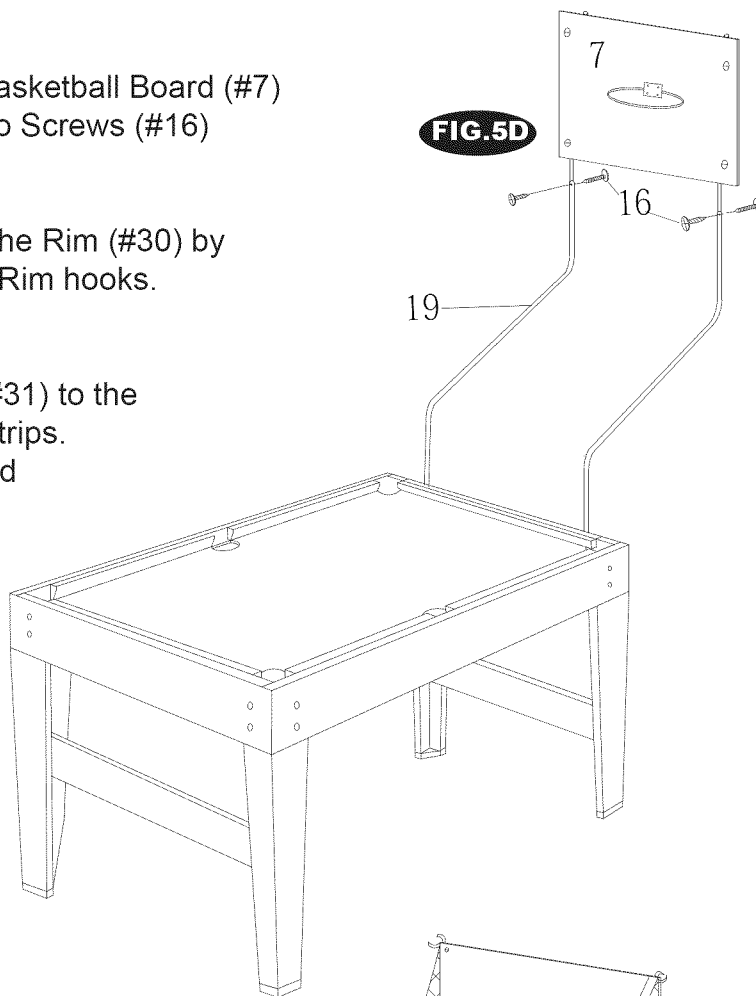

**FIG.5E**

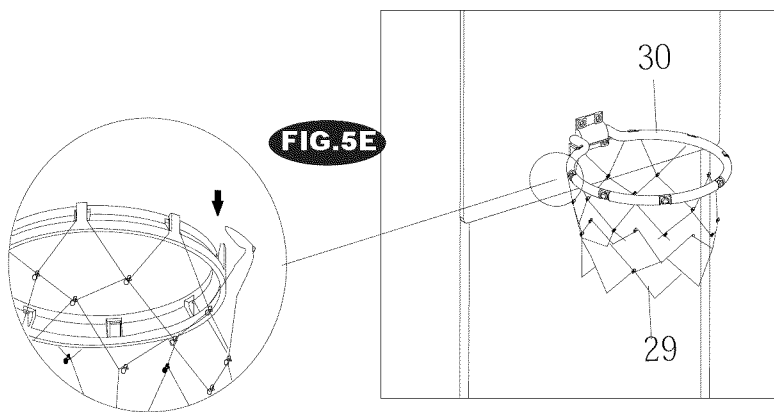

**FIG.5F**

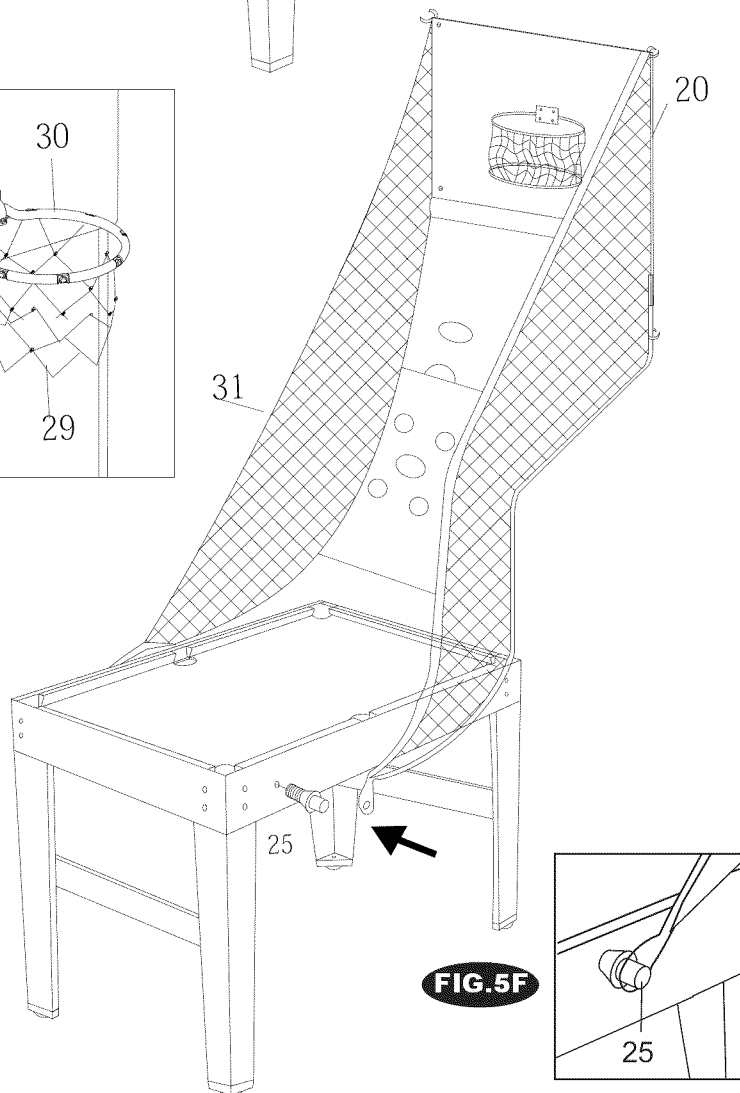



## FIG.6 PUSHER ASSEMBLY

18. Tear off the backside paper of the Felt Pad (#34) and stick them at the bottom of the Pushers (#33).

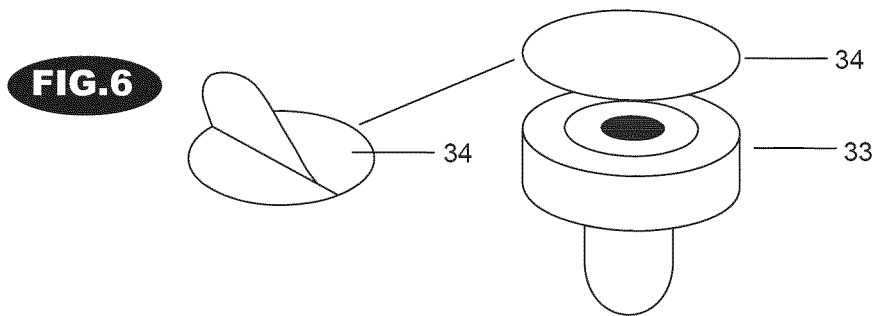

## DIRECTIONS FOR PLAYING VARIOUS GAMES

- 1) Billiard – play the game as assembled using the Cue (#39), Triangle (#38), Pool Balls (#37) and Chalk (#36).
- 2) Glide Hockey – place the Hockey Table with Table Tennis (#2) on the top of the Billiard Cabinet to play Glide Hockey using the Pusher (#33) and Puck (#35).
- 3) Table Tennis – Reverse side of the Hockey Table with Table Tennis (#2) and install the Net and Post set (#40). Use the Table Tennis Bats (#42) and Table Tennis Balls (#41).
- 4) Bowling – place the Backgammon with Bowling Board (#3) in the center of the Hockey Table with Table Tennis and use the Bowling Pin (#43) and Bowling (#44).
- 5) Chess, 6) Checker, 7) Backgammon – Reverse side of the Backgammon with Bowling Board (#3) to play these game use the Chess Set(#49), Backgammon/Checker Set (#50), Dice Box (#51) and Dice (#52).
- 8) Basketball – Attach the Basketball system and use the Basketball (#53).
- 9) Bean Bag Toss – throw Bean Bags (#46) against the pre-attached Target on the Basketball Return Net (#31).
- 10) Baseball Toss – play Baseball (#47) into the large opening on the Basketball Return Net.
- 11) Football – throw Football (#48) against the pre-attached Target on the Basketball Return Net (#31).
- 12) Tic-Tac-Toe – play on the Tic-Tac-Toe (#45).

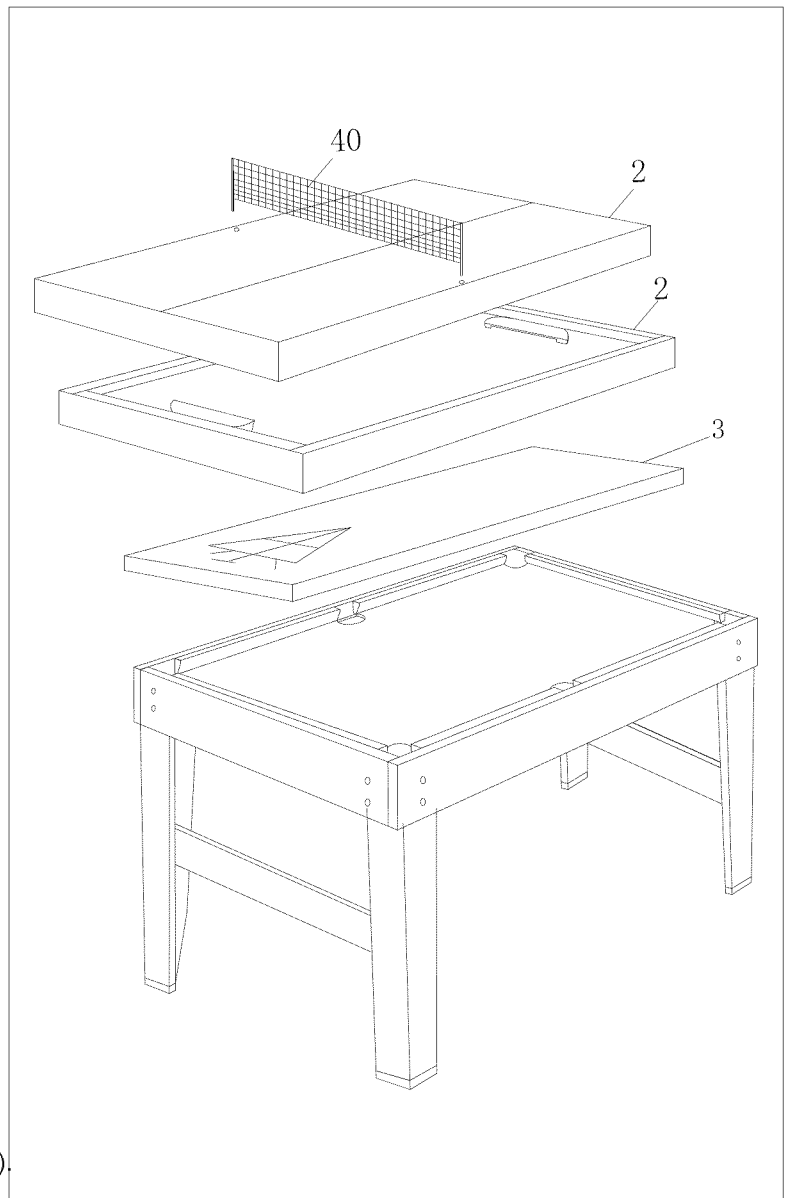

# **GARANTÍA LIMITA DE 90 DIAS**

Este producto está cubierto por una garantía efectiva de 90 días a partir de la fecha de su compra. La garantía cubre cualquier defecto en las partes y en la obra del trabajo.

Durante el período límite de la garantía, si una parte defectuosa o quebrada es encontrada, nosotros ofreceremos una reparación o un reemplazo de la parte sin ningún costo para ud, nuestro cliente. La única excepción que la garantía no fuera aplicada sería los daños causado por un uso inapropiado, alteración, uso equivocado, abuso, daño accidentado o negligencia.

El RECIBO DE LA COMPRA (o cualquier otra prueba de la fecha de su compra) sería requerida antes que cualquier servicio de garantía fuera iniciada. Cualquier requerimiento para el servicio de la garantía puede ser presentado por email, escrito o contactando a nuestro Dept. de Servicio del Consumidor en :

**Número telefónico gratis: 877-885-1635**  
**Email: [tablegame@medalsports.com.tw](mailto:tablegame@medalsports.com.tw)**  
**Website: [www.medalsports.com.tw](http://www.medalsports.com.tw)**

Esta garantía limitada le da a usted derechos legales específicos, usted también puede tener otros derechos que varían de un estado (provincia) a otro/a.

**POR FAVOR GUARDE ESTAS INSTRUCCIONES  
Y RECIBO DE LA COMPRA !  
NO DEVUELVA ESTE PRODUCTO A SU LOCAL DE VENTA!**

**¡Aviso Importante! No devuelva este producto a su local de venta.**

¡Por favor guarde las instrucciones. Es necesario el número de modelo para contactarse con nosotros. Por favor léa las instrucciones para poder familiarizarse con las piezas y los pasos para ensamblar. Corrobore que todas las piezas que aparecen en el "Identificador de Partes" se encuentren en el paquete.

A pesar de que nos dedicamos a dar los mejores productos posibles para nuestros clientes, pueden ocurrir problemas o faltar piezas. Si le faltan piezas ó si tiene alguna inquietud, por favor contáctenos lo antes posible a nuestro cordial centro de atención: **877-885-1635**

## Herramientas Necesarias:

Destornillador Phillips - **No incluido**

Destornillador de Cabeza Plana – **No incluido**

Llave Allen – **Incluido**

Los destornilladores eléctricos pueden ser de gran ayuda durante el ensamblado; sin embargo, por favor ajuste el par de giro bajo y sea extremadamente precavido porque las tuercas pueden ser barridas o sobreajustadas si el destornillador eléctrico está establecido muy alto.

## CONSEJOS PARA EL ENSAMBLADO

- 1- Cuando se instalen partes con más de un tornillo, ajústelo manualmente primero y luego con un atornillador o Llave Allen.
- 2- Algunos dibujos o figuras no se verán exactamente igual al producto. Por favor lea y comprenda el texto antes de empezar los pasos de ensamblado.

## PRECAUCIÓN

LEA Y SIGA CUIDADOSAMENTE TODAS LAS INSTRUCCIONES DE ENSAMBLAJE, OPERACIÓN Y SEGURIDAD. SE NECESITAN COMO MÍNIMO DOS ADULTOS FUERTES PARA EL MONTAJE DE ESTA MESA.

ÉSTE NO ES UN JUGUETE PARA NIÑOS. LA SUPERVISIÓN ADULTA ES NECESARIA DURANTE EL JUEGO CON NIÑOS. POR FAVOR LEA LAS INSTRUCCIONES CUIDADOSAMENTE. EL USO APROPIADO DEL JUEGO EVITARÁ DAÑOS O HERIDAS.













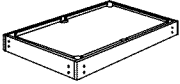
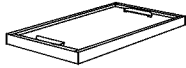



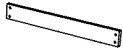

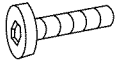
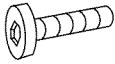

































**ADVERTENCIA:** Las tareas de montaje debe realizarlas un adulto.

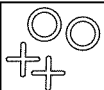

**ADVERTENCIA:**

PELIGRO DE ASFIXIO - - Este artículo contiene piezas pequeñas y pequeñas bolas. No apto para menores de 3 años.

# PARTS IDENTIFIER

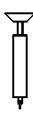
#1  Compartimiento del billar 1 Pieza	#2  Mesa de Hockey con Tenis de Mesa 1 Pieza	#3  Backgammon con Tablero del Boliche 1 Pieza	#4  Pata Izquierda 2 Piezas	#5  Pata Derecha 2 Piezas	#6  Panel del Lateral de la Pata 2 Piezas
#7  Tablero del Baloncesto 1 Pieza	#8  Perno 5/16" *1" 16 Piezas	#9  Perno 1/4"*1-1/8" 4 Piezas	#10  Perno 4*12mm 4 Piezas	#11  Perno de Mariposa 5/16" 4 Piezas	#12  Tuerca Hexagonal 1/4" 4 Piezas
#13  Tuerca de Acople 4mm 4 Piezas	#14  Tornillo de Plástico 8 Piezas	#15  Tornillo F3*1/2" 12 Piezas	#16  Tornillo P3.5*8mm 4 Piezas	#17  Tornillo 4*10mm 8 Piezas	#18  Tornillo 4*15mm 16 Piezas
#19  Palo Torcido 2 Piezas	#20  Palo Corto 2 Piezas	#21  Tronera Lateral 2 Piezas	#22  Tronera de la Esquina 4 Piezas	#23  Canasta de la Esquina 4 Piezas	#24  Canasta Lateral 2 Piezas
#25  Remache 2 Piezas	#26  Nivelador de la Pata 8mm 4 Piezas	#27  Base Plástico de la Pata 4 Piezas	#28  Tapón del Palo 2 Piezas	#29  Red del Baloncesto 1 Pieza	#30  Canasta 1 Pieza
#31  Red de la Devolución de Baloncesto 1 Pieza	#32  Llave Allen 1 Pieza	#33  Golpeador 2 Piezas	#34  Fieltro 2 Piezas	#35  Disco 2 Piezas	#36  Tiza 2 Piezas
#37  Bola de Billar 1.5" 1 Juego	#38  Triángulo 1.5" 1 Pieza	#39  Taco 36" 2 Piezas	#40  Red y poste de Tenis de Mesa 1 Set	#41  Pelota del Tenis de la Mesa 2 Piezas	#42  Paletas del Tenis de la Mesa 2 Piezas
#43  Pino del Boliche 1 Set	#44  Bola del Boliche 1 Pieza	#45  Tres en Línea 1 Juego	#46  Saquito Relleno 4 Piezas	#47  Béisbol 1 Pieza	#48  Fútbol 1 Pieza
#49  Juego de Ajedrez 1 Juego	#50  Conjunto de Backgammon y Dama 1 Juego	#51  Caja de dado 1 Pieza	#52  Dado 5 Piezas	#53  Baloncesto 1 Pieza	#54  Bomba de aire 1 Pieza

# IDENTIFICADOR DE PARTES

1. Encuentre un lugar limpio y nivelado para empezar a montar su Mesa de Combo. La mesa será montada con la parte superior guiado hacia abajo y una vez que el montaje es completado, se le voltea encima de sus patas. Esta mesa de juego es pesada y para voltearlo será requerido por lo menos dos adultos.
2. Retire todas las partes desde la caja y verifique que Ud. tiene todas las piezas como se muestra en el identificador de las partes como se le indica abajo. Cuidadosamente corte y arranque las cuatros esquinas de la caja de manera que la parte inferior de la caja pueda ser usada como su superficie para el trabajo.

## FIG.1 MONTAJE DE LA TRONERA

3. Asegure la Tronera Lateral (#21) en la parte inferior del Compartimiento del Billar (#1) usando cuatro Tornillos (#17) por cada Tronera Lateral. *Véa FIG.1*
4. Asegure la Tronera de la Esquina(#22) en la parte inferior del Compartimiento de Billar(#1) usando dos Tornillos (#18) por cada Tronera de la Esquina. *Véa Fig.1.*
5. Repita los pasos anteriores con las otras troneras.

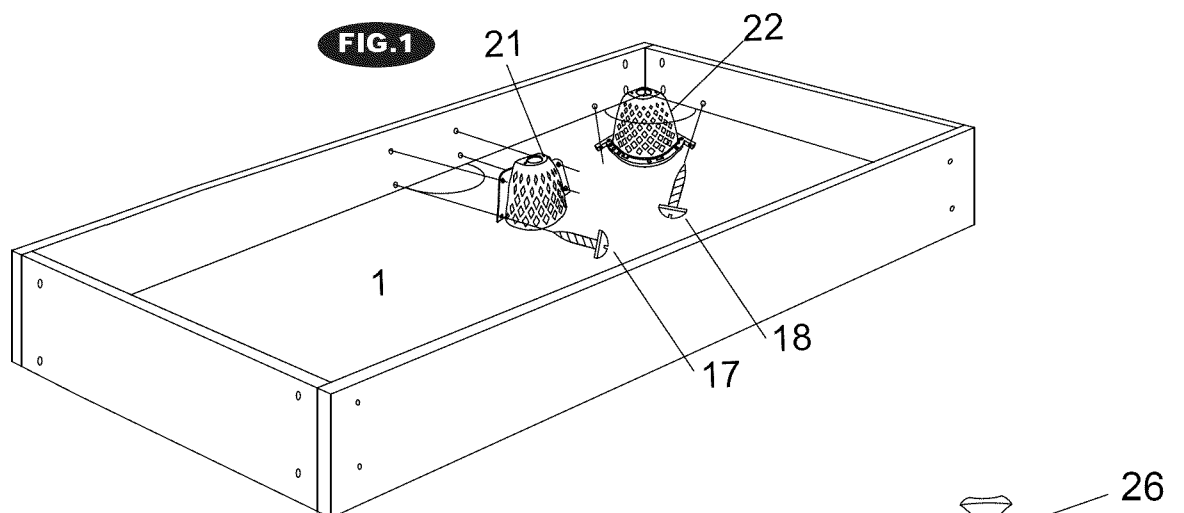

## FIG.2 MONTAJE DE LA PATA

6. Asegure Base Plástico de la Pata(#27) en la parte inferior de la Pata Izquierda (#4) y Derecha (#5) usando dos Tornillos Plásticos (#14) por cada Base de la Pata. *Véa FIG.2*
7. Luego, atornille el Nivelador de la Pata (#26) encima de la Base de la Pata (#27). *Véa FIG.2.*

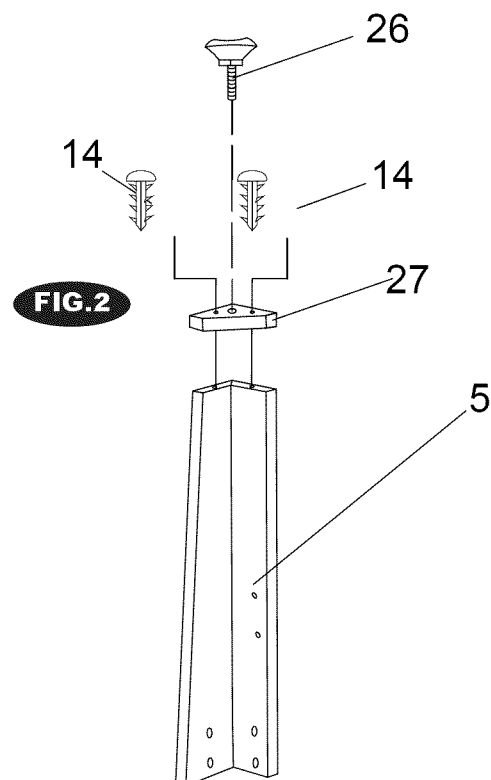

### FIG.3 MONTAJE DE LA MESA DE BILLAR

8. Fije las Patas previamente-montada (#4 y #5) en la parte final del Compartimiento de Billar (#1) usando cuatro Tornillos (#8). *Véa FIG.3.*
9. Fije el Panel del Lateral de la Pata (#6) entre la parte interior de la Pata Izquierda y Derecha usando cuatro Tornillos (#18) por cada Panel del Lateral de la Pata. *Véa FIG.3.*

FIG.3

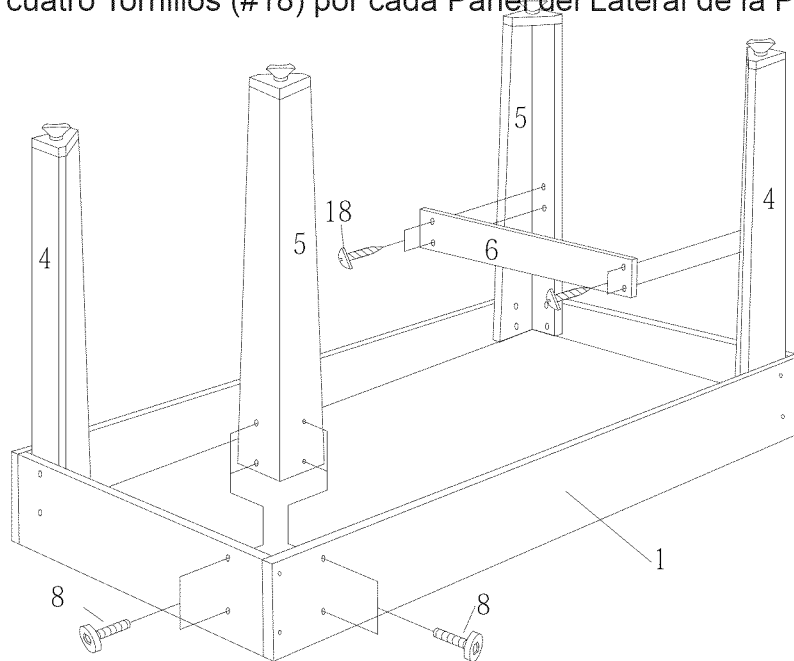

10. Levante la mesa montada desde el piso con dos adultos fuertes, voltéalo, y ponga las patas en el lugar donde Ud. juega. Vuelva a asegurar que todas las conexiones estén bien apretadas.

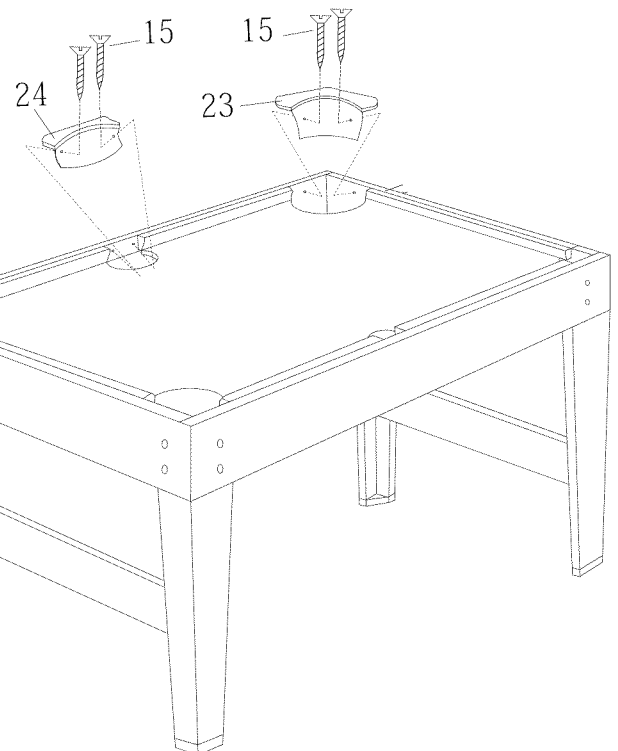

### FIG.4 MONTAJE DE LA CANASTA DE LA MESA DE BILLAR

11. Fije la Canasta de la Esquina (#23) y la Canasta Lateral (#24) al Compartimiento de Billar (#1) usando dos Tornillos (#15) por Canasta. *Véa FIG.4*

**Advertencia:**

Se recomienda que dos adultos fuertes le den la vuelta a la mesa como se muestra.

1. Levante la mesa del suelo.
2. Dele la vuelta a la mesa.
3. Póngala sobre las cuatro patas al mismo tiempo.

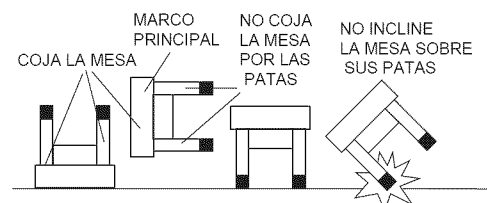

## FIG.5 MONTAJE DEL BALONCESTO

12. Fije al Palo Torcido (#19) en la final de la Mesa del Billar usando dos Pernos de Mariposa (#11) por cada Palo Torcido. **Véa FIG.5.A**
13. Fije a la Canasta (#30) sobre el Tablero del Baloncesto(#7) usando cuatro Pernos (#10) y cuatro Tuercas (#13). **Véa FIG.5B.**
14. Fije el Palo Corto (#20) detrás del Tablero del Baloncesto(#7) usando cuatro Pernos (#9) y cuatro Tuercas (#12). Y luego, instale el Tapón del Palo (#28) sobre el extremo superior del Palo Corto(#20). **Véa FIG.5C.**

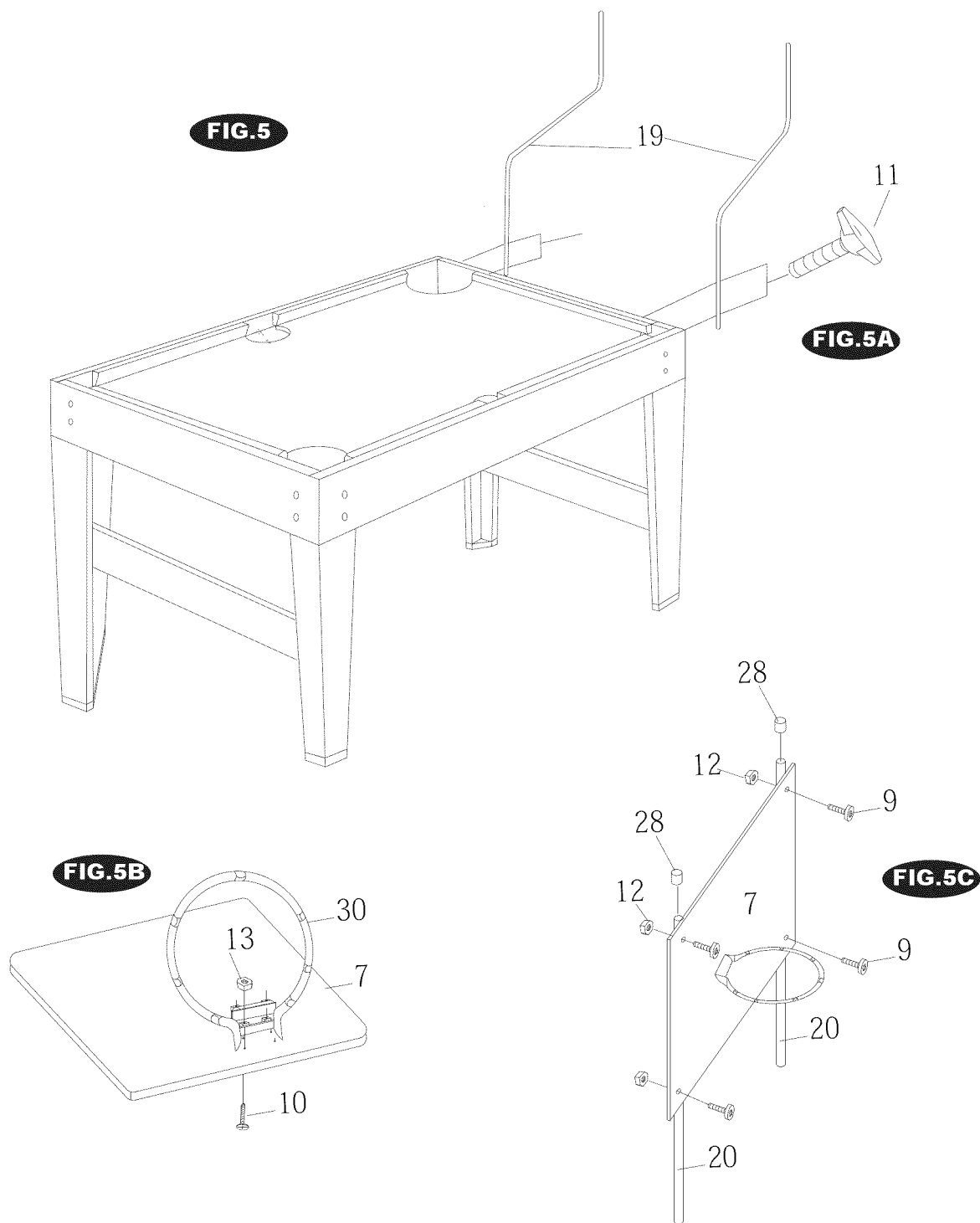

15. Fije al Tablero de Baloncesto (#7) previamente montado en el Palo Torcido (#19) usando dos Tornillos (#16) por cada lado. *Véa FIG.5D.*

16. Fije la Red del Baloncesto (#29) en la Canasta (#30) deslizándolo la parte superior de la red sobre los ganchos de la Canasta. *Véa FIG.5E.*

17. Fije la Red de la Devolución del Baloncesto (#31) al Palo Corto (#20) usando la faja de Velcro. Asegure la parte inferior de éste a la Mesa de Billar usando dos Remaches (#25). *Véa FIG.5F*

**FIG.5D**

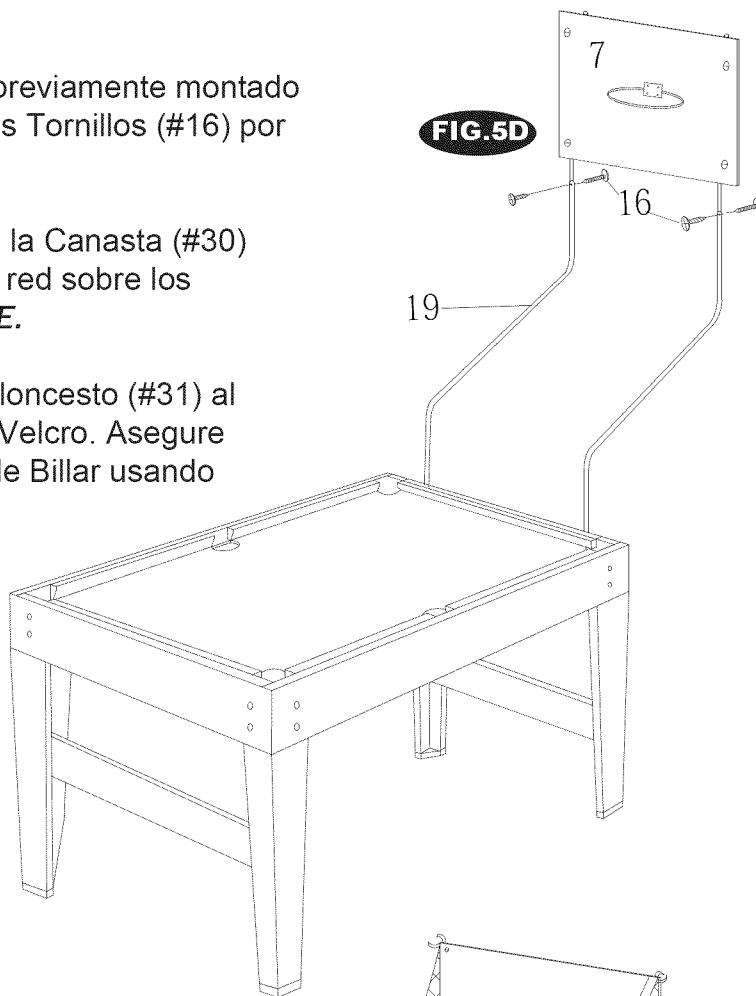

**FIG.5E**

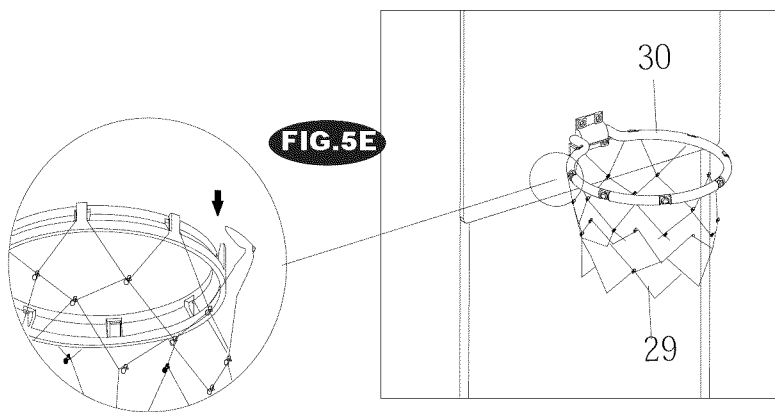

**FIG.5F**

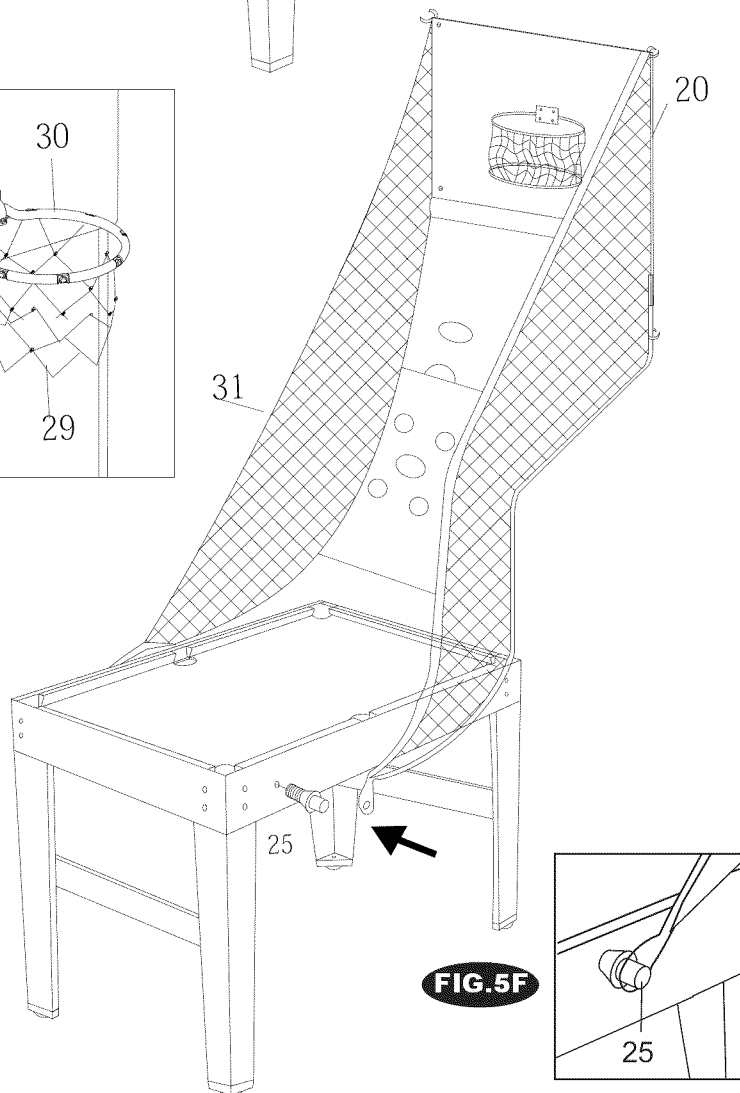



## FIG.6 MONTAJE DEL GOLPEADOR

18. Desgarre el papel que está detrás del fieltro(#34) y fíjelo en la parte inferior de los Golpeadores (#33).

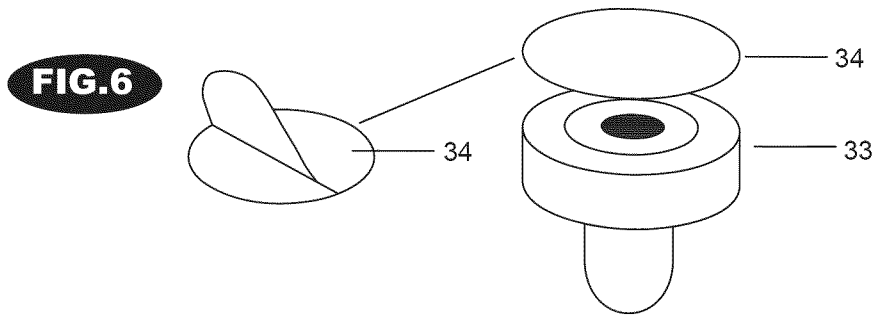

## GUÍA PARA JUGAR VARIOS JUEGOS

- 1) Billar – juegue el juego tal como está montado con el Taco (#39), Triángulo (#38), bolas de Billar (#37) y Tiza (#36).
- 2) Deslizamiento de Hockey – ponga la Mesa de Hockey con el Tenis de Mesa (#2) sobre la parte superior del compartimiento de Billar para jugar el Deslizamiento de Hockey usando el Golpeador (#33) y el Disco (#35)
- 3) Tenis de Mesa – Voltee a la Mesa de Hockey con el Tenis de Mesa(#2) e instale el conjunto de la red y el poste (#40). Use las paletas de Tenis de Mesa (#42) y la pelota de Tenis de Mesa (#41).
- 4) Boliche – ponga el Backgammon con el Tablero de Boliche (#3) en el centro de la Mesa de Hockey con Tenis de Mesa y use el Pino del Boliche (#43) y la Bola del Boliche (#44).
- 5) Ajedrez, 6) Damas, 7) Backgammon – Voltee al Tablero del Backgammon y el Boliche (#3) para jugar a estos juegos use Juego de Ajedrez(49), Conjunto de Backgammon y Dama(#50), Caja de dado (#51) y Dado (#52).
- 8) Baloncesto- Asegure el sistema del Baloncesto y use el Baloncesto (#53).
- 9) Lanzamiento de Saquitos Rellenos – Lance los saquitos rellenos (#46) contra el blanco previamente instalado sobre el la Red de la Devolución del Baloncesto (#31).
- 10) Lanzamiento del Béisbol – Juegue el Béisbol (#47) dentro de la abertura sobre la Red de la Devolución del Baloncesto.
- 11) Fútbol – Lance los Fútbol (#48) contra el blanco previamente instalado sobre el la Red de la Devolución del Baloncesto (#31).
- 12) Tres en Línea – se juega sobre Tres en Línea (#45).

