

VIORE™ TECHNOLOGY & INNOVATION

OPERATING INSTRUCTIONS

24" 1080p LED Backlight LCD Television with Built-in DVD Player LED24VF65D



AIR (TV)/CABLE MODE SELECTION

The Air/CABLE menu option is set to the "CABLE" (Cable Television) mode at the factory. If you want to use an antenna for the built-in TV tuner, this menu option must be set to the "Air" mode. Please refer to page 19 of the owner's manual for the details of this menu.

	FOR QUESTIONS OR TECHNICAL SUPPORT
	Please call:
	1-877-777-1428 (USA / PUERTO RICO)
	1-877-777-1429 (CANADA)
Please do not return this TV to the store.	

Contents

Caution	2
Safety Information	3

Unit and Accessories	4
Product Feature	4

Introduction	5-8
1. Front View	5
2. Rear View	6
3. Remote Control	7-8

Connection	9-11
-------------------	-------------

Basic Operation	12-13
------------------------	--------------

OSD Menu	14-20
1. Picture menu	14
2. Audio menu	15
3. Time menu	16
4. Setup menu	17
5. Lock menu	18
6. Channel menu	19-20

DVD Operations	21-27
DVD basic operation	21-24
DVD System Setup	25-26
Disc Care	27

Simple Troubleshooting	28
-------------------------------	-----------

Technical Specifications	29
---------------------------------	-----------

Caution



The lightning flash with arrowhead symbol, within an equilateral triangle is intended to alert the user to the presence of un-insulated "dangerous voltage" within the products enclosure that may be of sufficient magnitude to constitute a risk of electric shock to the persons.



The exclamation point within an equilateral triangle is intend to alert the user to the presence of important operating and maintenance (servicing) instructions in the literature accompanying the appliance.

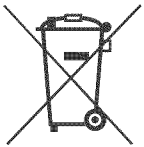

Correct disposal of this Product

(Waste Electrical & Electronic Equipment (WEEE))

Your product is designed and manufactured with high quality materials and components which can be recycled and reused.

This symbol means that electrical and electronic equipment, at their end-of-life should be disposed of separately from your household waste.

Please dispose of this equipment at your local community waste collection/ recycling centre.

In the USA there are separate collection systems for used electrical and electronic products. Please help us to conserve the environment we live in!

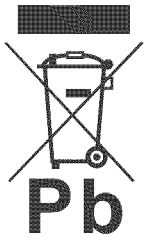

This unit complies with America Safety directives.

3124140
CONFORMS TO UL STD. 60065



This unit complies with FCC directives.

Safety Information

To ensure reliable and safe operation of this equipment, please read carefully all the instructions in this user guide, especially the safety information below.

Electrical safety

- The TV set should only be connected to a mains supply which matches that stated on the label on the mains adaptor
- To prevent overload, don't share the same mains supply socket with too many other items of equipment.
 - Do not place any connecting wires where they may be stepped on or tripped over.
 - Do not place heavy items on the leads, which may damage them.
 - Hold the Mains plug, not the wires, when removing from a socket.
 - During a thunderstorm or while leaving the TV for long periods, disconnect the aerial (if outdoor) and mains adaptor from the supply.
 - Do not allow water or moisture to enter the TV or mains adaptor. Do NOT use in wet or moist areas such as Bathrooms, steamy kitchens or near swimming pools.
- Pull the plug out immediately, and seek professional help if:
 - the mains plug or cable is damaged
 - liquid is spilt onto the set, or if it is accidentally exposed to water or moisture
 - anything accidentally penetrates the ventilation slots
 - the set does not work normally.
 - Do NOT remove the safety covers. There are no user serviceable parts inside. You may invalidate the warranty. Qualified personnel only are permitted to service this apparatus.
 - To avoid battery leakage, remove exhausted batteries from the remote control handset, or when not using for along period.
 - Do NOT break open or throw exhausted batteries on a fire.

Physical safety

- Do NOT block ventilation slots in the back cover. You may place the TV in a cabinet, but ensure at least 5cm (2") clearance all around the unit.
- Do NOT tap or shake the TV screen, you may damage the internal circuitry. Take good care of the remote control, do not drop it or allow it to come into contact with liquids.
- To clean the TV use a soft dry cloth. Do NOT use solvents or petrol based fluids. For stubborn stains, you may use a damp soft cloth with diluted detergent.

Unit and Accessories

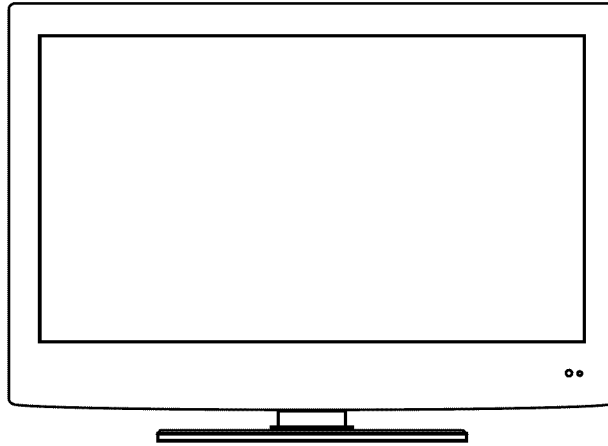

TV set

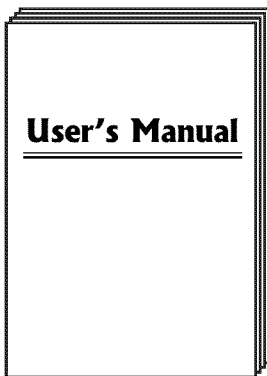

User's manual



Remote control
Batteries: 2xAAA

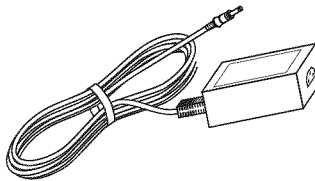

Mains adaptor

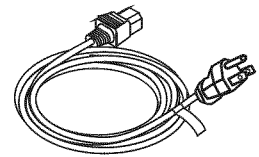

Mains cable

Product Feature

- 23.6" (measured diagonally) wide screen for a complete home theater experience
- Energy Saving TV – more natural colors and better picture quality than conventional LCD TVs with less power consumption
- Made of 95% recyclable materials
- 1920 x 1080 native resolution for Full-HD (1080p) performance
- Integrated ATSC TV tuner for HDTV broadcast reception
- Dual HDMI input for true digital connections
- VGA port for connection to PC
- Built-in DVD Player

Introduction

1. Front View

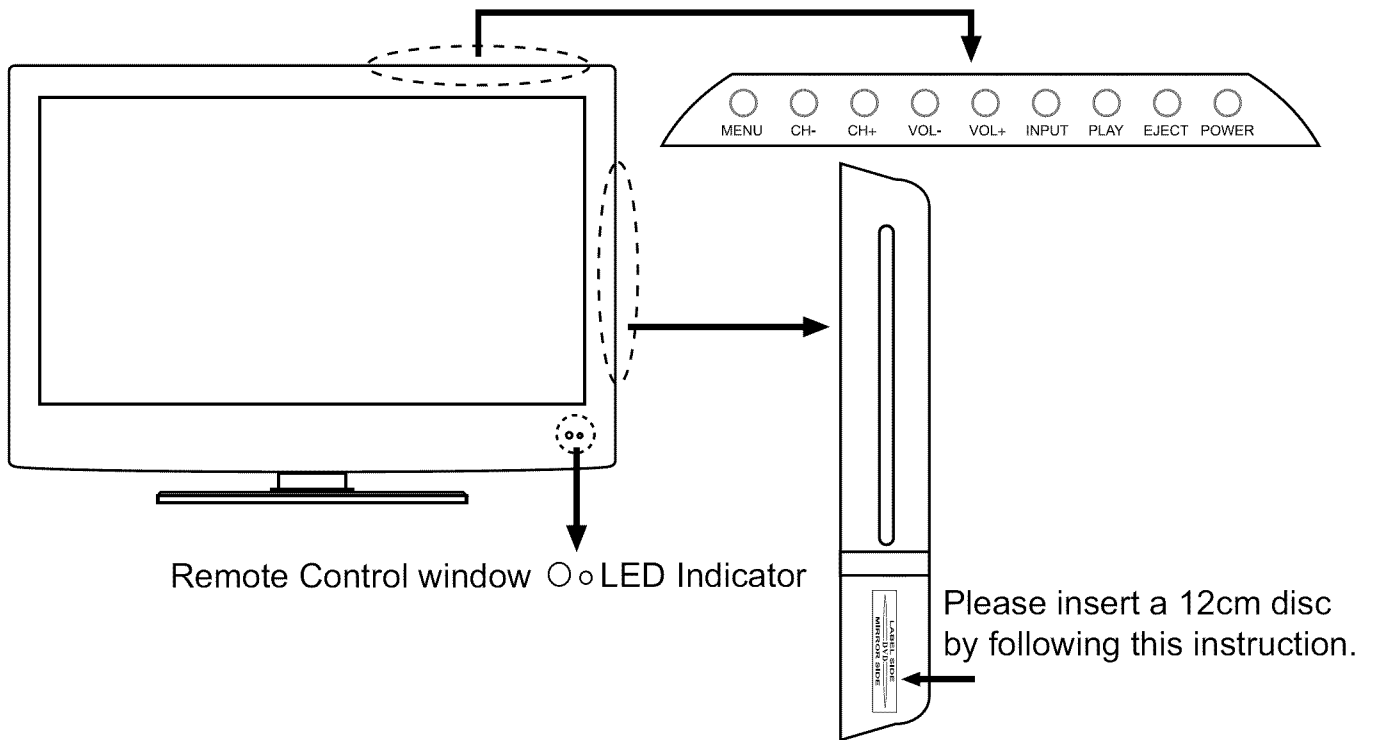

- (IR) Infrared Receiver: Receives IR signals from the remote control.
 (Power on/Standby)LED Indicator: Press **POWER** to turn on and off.
 Indicator on(Red) Standby mode
 Indicator on(Green) Power on mode

The effective receiving range for the signal is 5-8 metres from the front of the remote control window, and 30° to the left or right side and 20° above or below the remote control window.

2. The functions of the buttons:

- MENU:** Press to display the OSD menu, press again to exit the menu.
- CH+/-:** Press to scan through channels.
- VOL+/-:** Press to adjust the volume.
- INPUT:** Press to display the input source menu.
- PLAY:** Play/pause the DVD program.
- EJECT:** Eject the disc.
- POWER:** Turn on/standby the TV set.

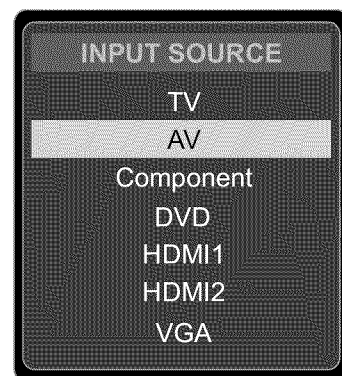

Press **INPUT** button on the TV set or remote control to display the input source menu, and use **CH+/-** button on the TV set or **^ / v** button on remote control to select the input source, press **OK** button on the remote control to enter.

Note: Before you select the input source, make sure the connections are prepared.

2. Rear View

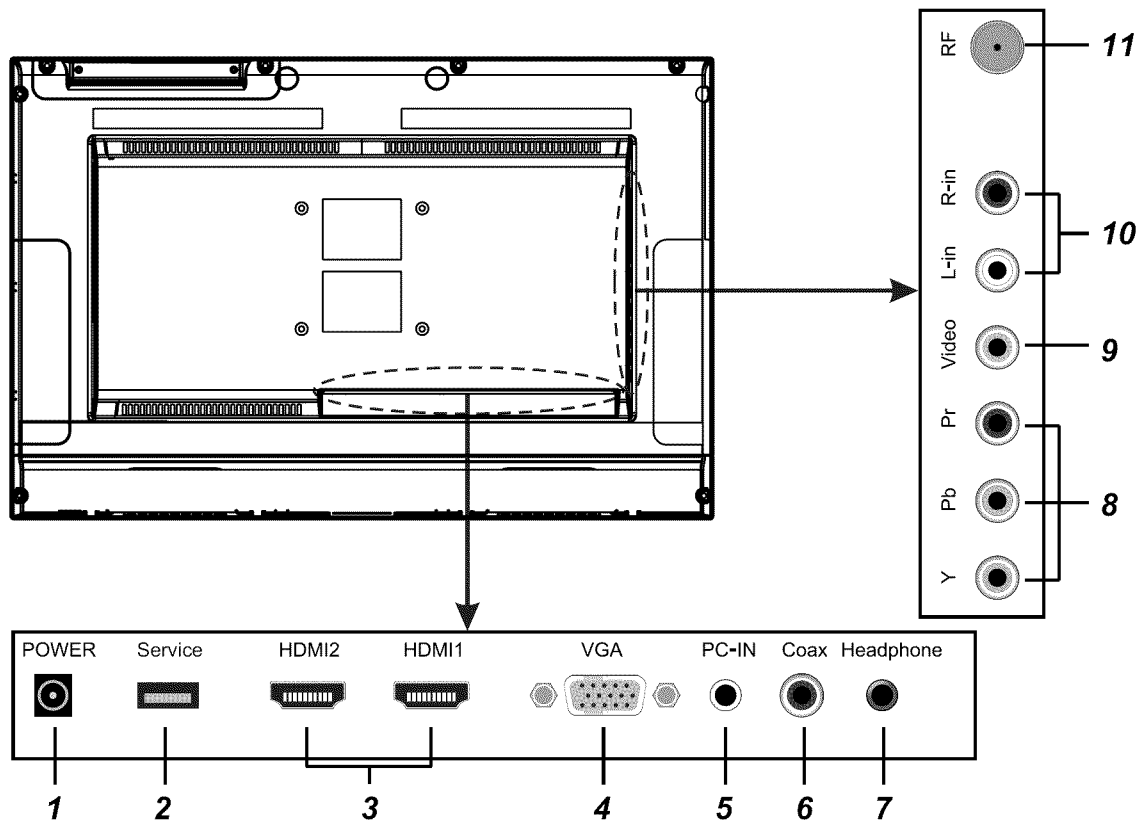

1. **POWER:** Connect to the mains adaptor.
2. **Service :** For software update only.
3. **HDMI1/2:** Connect it to the HDMI of DVD or other equipment.
4. **VGA:** For PC display. Connect it to the D-Sub 15 pins analog output connector of the PC.
5. **PC-IN:** Connect it to the audio output terminal of PC.
6. **Coax:** Digital coaxial output.
7. **Headphone:** Connect it to your headphone or other audio equipment.
8. **YPbPr:** Connect them to the YPbPr video output terminal of DVD.(used in component source)
9. **VIDEO:** Connect it to video output terminal of DVD.
10. **R/L in:** Connect them to the audio output terminal of DVD.(shared with YPbPr)
11. **RF:** Connect antenna or cable 75 Ohm coaxial to receive TV signal.

Wall Mounting

The TV is provided with mounting holes for a VESA approved wall mounting bracket (NOT SUPPLIED). Remove the pozi screws holding the base to the base bracket and lift the base away (do not remove the base mounting bracket). Mount the VESA bracket using 4 x M4 x10 Iso metric threaded screws (not supplied). Do not use screws longer than 10 mm, damage will occur to the internal parts. Fit the wall bracket securely following the manufacturer's instructions.

3. Remote Control

The remote control is using Infra-Red(IR). Point it towards the front of the LCD TV. The remote control may not work correctly if it is operated out of range or out of angle.

POWER
Press to turn the TV on/standby

PICTURE
Press repeatedly to cycle through the available video picture modes.

SOUND
Press to cycle through the different sound settings.

SLEEP
Press to setup the sleep time

DISPLAY
Press to enter the EPG menu directly.

CH+/-
Channel/Program +/-

VOL+/-
Volume +/-

MENU
Press to display the OSD menu.

EXIT
Press to exit from the OSD menu.



INPUT
Press to display the input source menu

NUMBER BUTTONS
To select the program directly.
e.g.:
Select channel 5, press "5" button.
Select channel 62, press "6" button, and press "2" button in 2 seconds.
Select channel 152, press "1" button, and press "5" button, then press "2" button in 2 seconds.
select channel "5-1", press "5" then "-/-" and "1".

Return to the previous channel viewed.

MUTE
Press to mute the sound. Press again or press VOL+ to unmute.

THUMBSTICK (▲/▼/◀/▶/OK)
Allows you to navigate the on-screen menus and adjust the system settings to your preference.

CC
Press to display the closed caption.

MTS
Press to select the audio channels.

EPG
Press to enter the EPG menu directly.

FAV
Press to display the favorite channels list.

Introduction

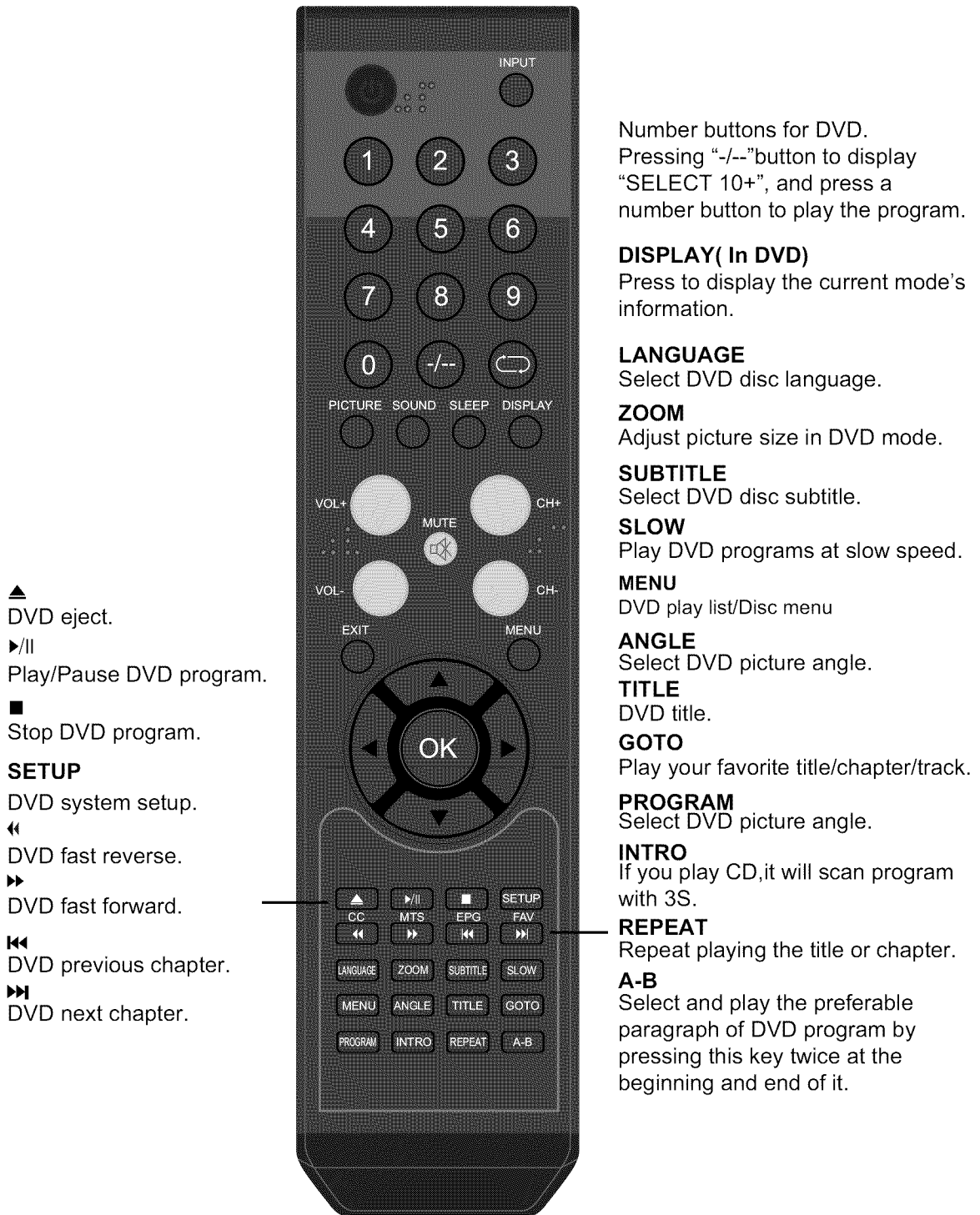

- ▲ DVD eject.
- ▶/|| Play/Pause DVD program.
- Stop DVD program.
- SETUP**
DVD system setup.
- ◀◀ DVD fast reverse.
- ▶▶ DVD fast forward.
- ◀◀◀ DVD previous chapter.
- ▶▶▶ DVD next chapter.

Number buttons for DVD.
Pressing “-/--”button to display “SELECT 10+”, and press a number button to play the program.

DISPLAY(In DVD)

Press to display the current mode's information.

LANGUAGE

Select DVD disc language.

ZOOM

Adjust picture size in DVD mode.

SUBTITLE

Select DVD disc subtitle.

SLOW

Play DVD programs at slow speed.

MENU

DVD play list/Disc menu

ANGLE

Select DVD picture angle.

TITLE

DVD title.

GOTO

Play your favorite title/chapter/track.

PROGRAM

Select DVD picture angle.

INTRO

If you play CD, it will scan program with 3S.

REPEAT

Repeat playing the title or chapter.

A-B

Select and play the preferable paragraph of DVD program by pressing this key twice at the beginning and end of it.

Installing Batteries

1. Open the battery compartment cover on the back of the remote control.
2. Insert two 1.5V AAA size batteries observing the polarity markings inside the battery compartment. Don't mix different types or used batteries with new ones.
3. Close the cover.



Batteries shall not be exposed to excessive heat such as sunshine or fire.

- The remote control should be operated within 30 feet(7m) and 30° to the left and right of the IR receive at the front of the LCD TV.
- Used batteries should be disposed properly.

Connection

Power Cord Connection

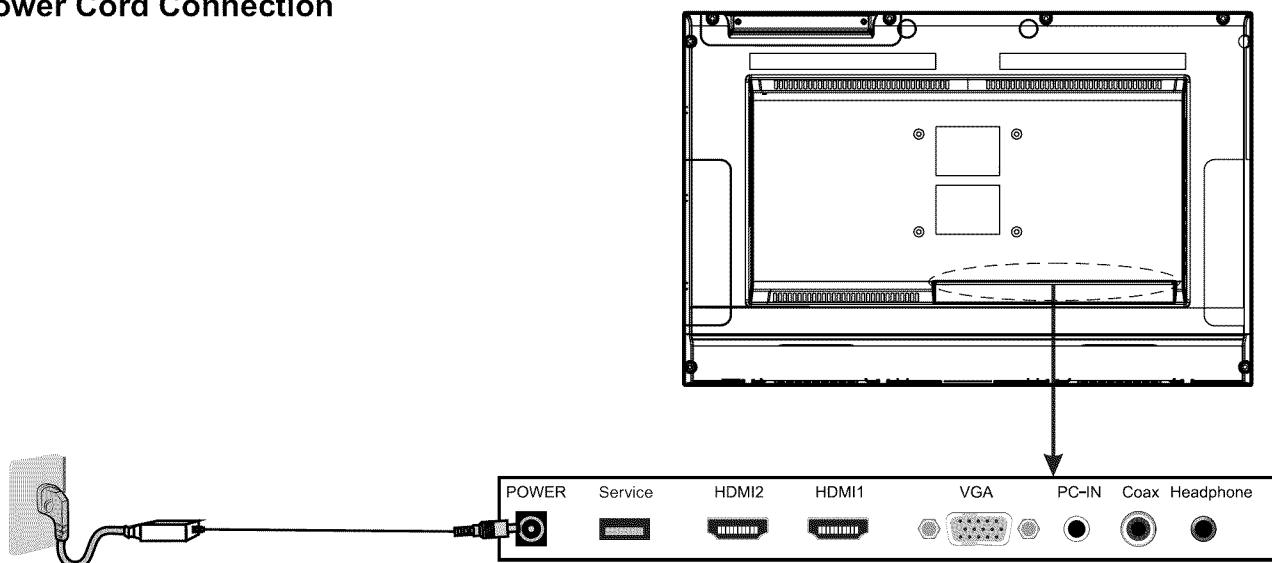

- Connect to the power supply correctly as shown with the mains cable and mains adaptor.
- When you connect the power, the TV set comes into standby mode and the LED indicator (Page 5) lights red.
- You could bring the TV out of standby mode by press the **POWER** button on TV set (page 5) or remote control(page 7), and the LED indicator lights green.

Antenna (RF) Connection

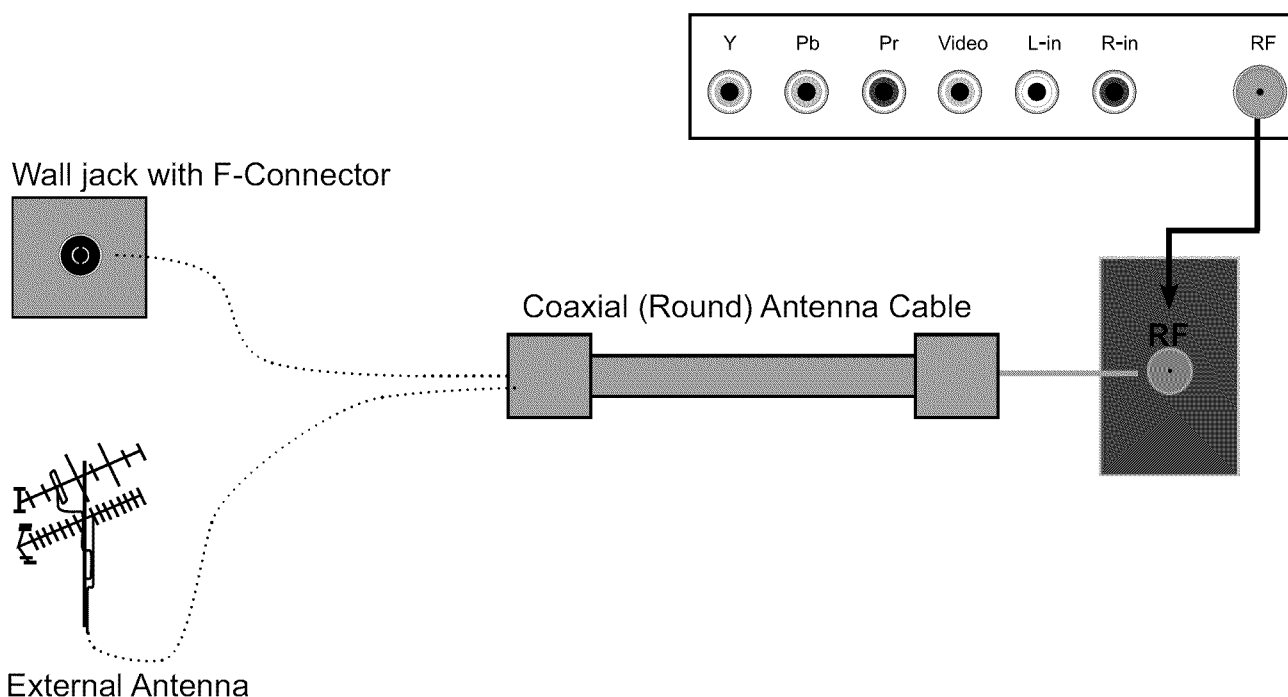

Press **INPUT** button on the remote control to display the input source menu, press \wedge / \vee button to select **TV**, then press **OK** button to confirm, and you will receive the signal.

Connection

AV Input Connection

Note: All cables shown are not included with the TV.

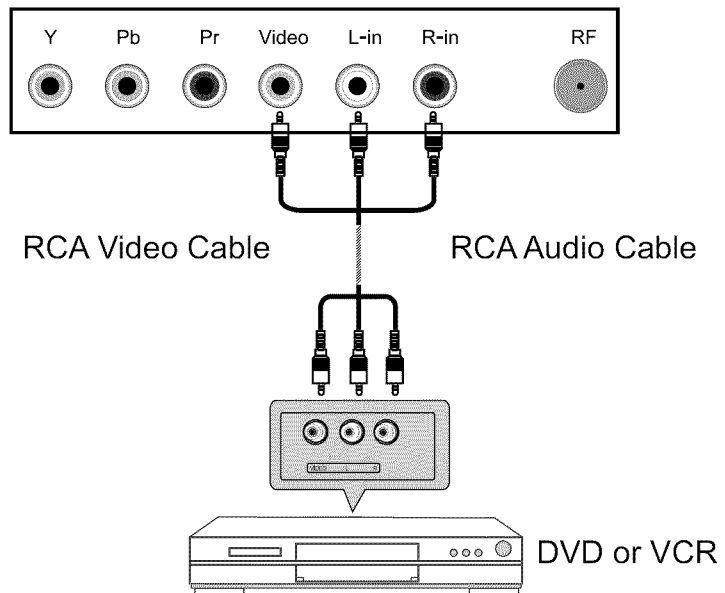

- Connect the VIDEO and AUDIO output jacks on the DVD or VCR to the AV IN jacks on the TV set with a RCA cable.
- Match the jacks colors: **Video=yellow, Audio left=White, Audio right=red.**
- Turn on the DVD/VCR, and select **"AV"** in the input source menu.

YPbPr Connection

Note: All cables shown are not included with the TV.

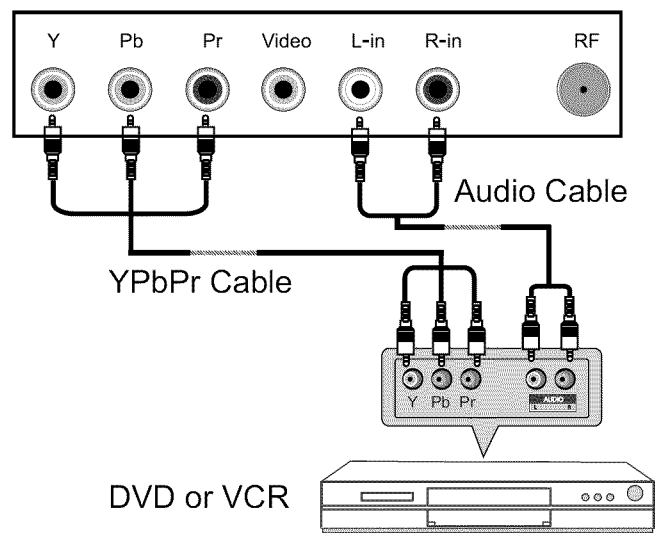

- Connect the YPbPr output jacks on the DVD or VCR to the YPbPr input jacks on the TV set with a YPbPr cable. The picture quality is improved compared to a regular VCR to the video input.
- Match the jacks colors: **Y=Green, Pb=Blue, Pr=red.**
- Connect the audio output jacks on the DVD or VCR to the audio input jacks on the set with an audio cable.
- Turn on the DVD/VCR, and select **"YPbPr"** in the input source menu.

HDMI Connection

Note: All cables shown are not included with the TV.

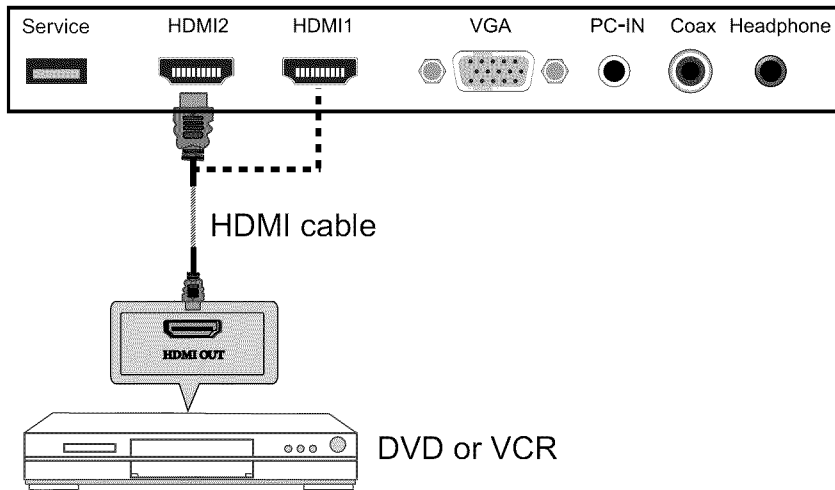

- Connect the HDMI jack on the DVD to the HDMI jack on the TV set with a HDMI cable.
- Turn on the DVD, and select "HDMI1/2" in the input source menu.
- HDMI (High Definition Multimedia Interface) is the first all digital consumer electronics A/V interface that supports uncompressed standard. One jack supports both video and audio information.

PC Connection

Note: All cables shown are not included with the TV.

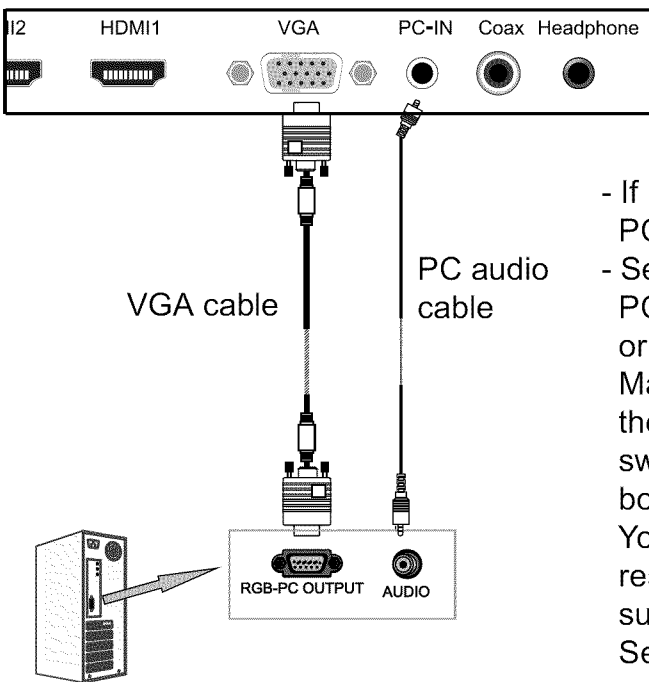

- If using a sound card, adjust the PC sound as required.
- Set the video resolution of your PC to 1024x768, 60Hz on its original monitor. Make the connections between the TV monitor and your PC, switch on the monitor before booting the PC. You can now set your preferred resolution from the choice supported. See the table of supported resolutions on the right.

Supported PC resolutions
640 x 480, 60 Hz
800 x 600, 60 Hz
1024 x 768, 60 Hz
1920 x 1080, 60Hz



- Connect the RGB jack on the PC to the VGA jack on the TV set with a VGA cable.
- Connect the audio output jack on the PC to the PC IN jack on the TV set with a stereo audio cable.
- Turn on the PC, and select "VGA" in the input source menu.

Basic Operation

Power on/off

1. Connect to the power with a mains cable and an adaptor (page9).

2.-To turn on the TV

Press **POWER** button on the TV or remote control.

-To turn off the TV

Press **POWER** button on the TV or remote control.

Input Source select

Press **INPUT** button on the TV set or remote control to display the input source menu, and use **CH+/-** button on the TV set or \wedge / \vee button on remote control to select the input source, press **OK** button on the remote control to enter.

Note: Before you select the input source, make sure the connections are prepared.

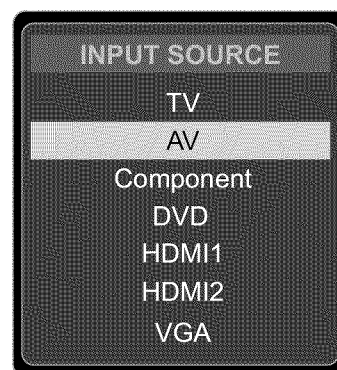

Basic buttons on the remote control

POWER(red button): Turn the TV on/standby.

INPUT: Press to display the input source menu.

Number Buttons: Choose channel directly.

Select channel 5, Press button "5";

Select channel 62, Press button "6", then press button "2" in 2 seconds;

Select channel 151, Press button "1", and press button "5" in 2 seconds, and press button "1" in 2 seconds;

Select channel 5-1, Press button "5", and press button "- / -" in 2 seconds, and press button "1" in 2 seconds;

\curvearrowright (**RETURN**): Return to the previous channel viewed.

PICTURE: Press repeatedly to cycle through the available video picture modes.

SOUND: Press to cycle through the different sound settings.

SLEEP: Shutdown timer.

DISPLAY: Display the information of current mode.

VOL+/-: Press to adjust the volume.

CH+/-: Press to scan through channels.

MUTE: Press to mute the sound, press again or press VOL+ to unmute.

MENU: Press to display the OSD menu.

EXIT: Press to exit the OSD menu.

Thumbstick($\leftarrow \rightarrow \wedge \vee$): Allows you to navigate the on-screen menus and adjust the system settings to your preference.

OK: CONFIRM button.

Basic OSD Menu operation

Press **MENU** button to display the OSD menu as below:

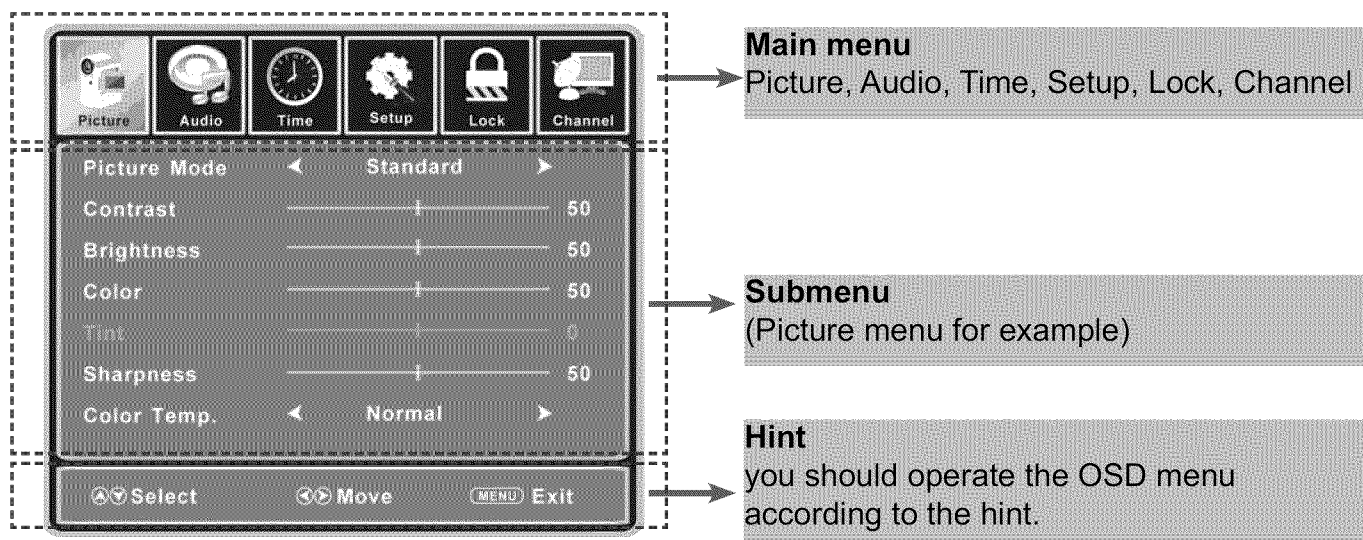

Use < / > button to select the main menu, and press √ button to enter the submenu.

In the submenu, use ^ / v button to select the function item, and you could:

adjust ("Contrast" item in **Picture** menu for example) with < / > button;

select ("Picture Mode" item in **Picture** menu for example) with < / > button;

enter the submenu ("Close Caption" item in **Setup** menu for example) with > button.

* (Press MENU button to return to the upper menu.)

* (Press EXIT button to exit the menu display.)

Note1: Only when you input the suitable signal, the relevant items can be activated

Note2: Please operating the OSD menu according to hint on the bottom of the banner.

OSD Menu

1. Picture menu

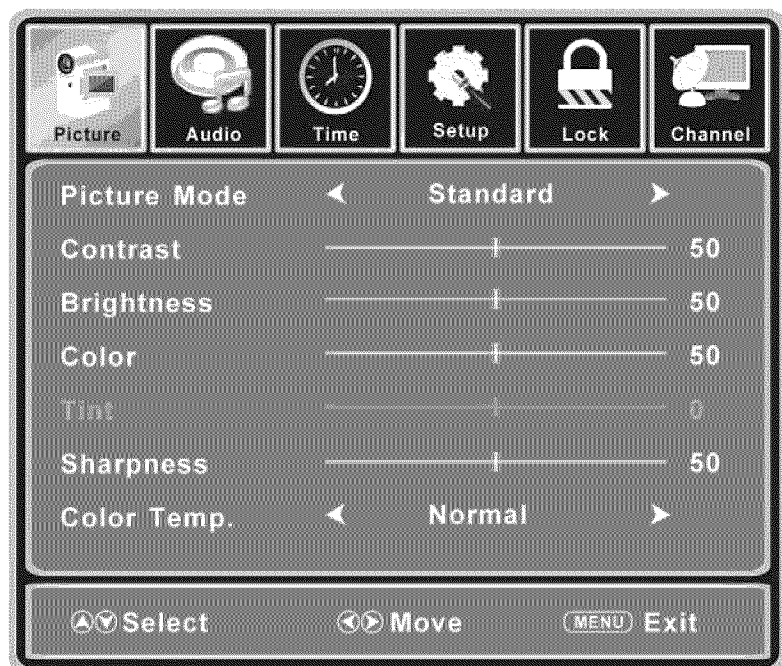

Description

Picture mode: Select between Standard, Dynamic, Mild, Sports and User.

You may select the picture mode directly by pressing the **PICTURE** button on the remote control.

Contrast: Control the difference between the bright and dark regions of the screen picture.

Brightness: Adjust brightness of the picture.

Color: Adjust color of the picture.

Tint: Control the fresh tones to make them appear natural.

Sharpness: Set the amount of fine detail in the picture.

Color Temp.: Select between Normal, Cool and Warm.

2. Audio menu

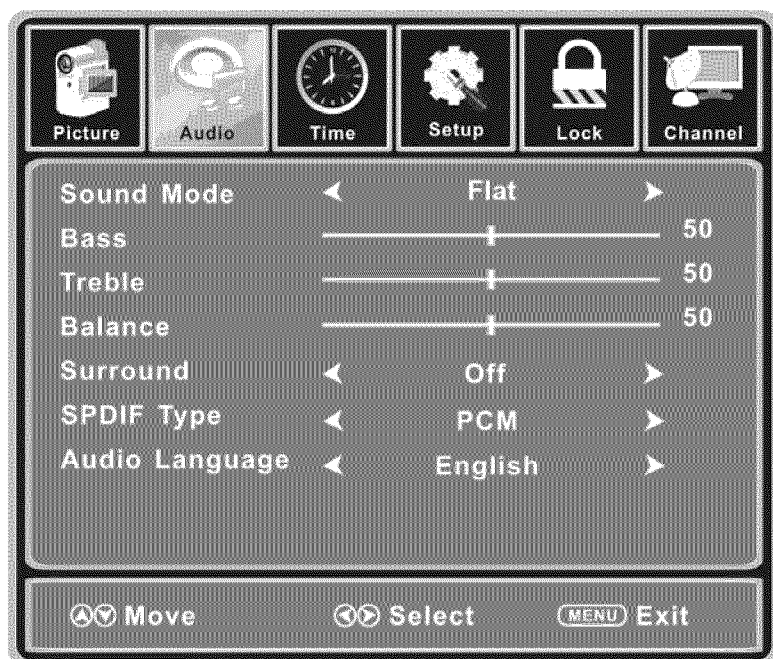

Description

Sound Mode: Select your desired picture mode as follow: Flat, Music, Movie, Sports and User
You may select the sound mode directly by pressing the **SOUND** button on the remote control.

Bass: Low frequencies intensity.

Treble: High frequencies intensity.

Balance: Left and right stereo audio channels balance.

Surround: Activate or deactivate the Surround function.

SPDIF Type: Select spdif type between PCM and RAW.

Audio Language: Select audio language.

3. Time menu



Description

Sleep timer: You may set the automatic shutdown timer choosing from 5 to 240 minutes, or deactivate this function.

Time zone: Select between Pacific, Alaska, Hawaii, Eastern, Central and Mountain.

Daylight Saving Time: Select between On and Off.

Clock: User can not change time manually during DTV mode, for time is from signal source directly.

4. Setup menu

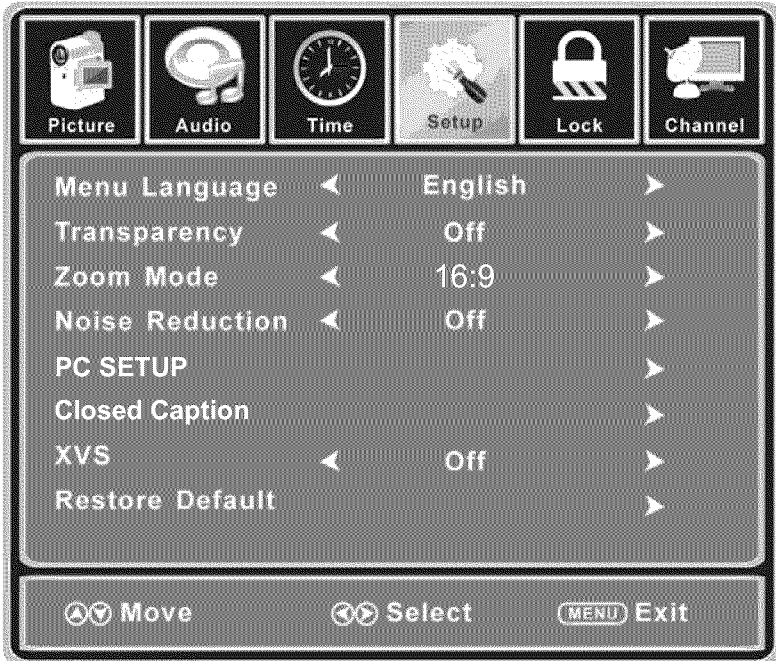

Description

Menu Language: Select OSD menu language.

Transparency: Turn on or off the transparency menu function.

Zoom Mode: Select the zoom mode between 16:9, 16:9 zoom, 4:3, 4:3 zoom.

Noise reduction: Select the noise reduction mode between Strong, Off, Weak and Middle.

PC SETUP: If the video input signal comes from your PC, you may adjust the V-Position, H-Position, Frequency, Phase or even perform an Auto adjustment.

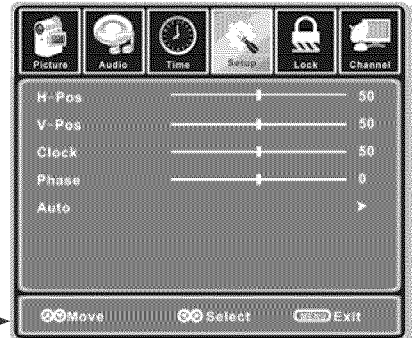

Closed Caption:

CC Mode: Allow you to select the CC Mode among: On, Off and CC on Mute.

Basic Selection: Allow you to select the basic selection among: CC1, CC2, CC3, CC4, Text1, Text2, Text3 and Text4.

Advanced Selection: Allow you to select the advanced selection among: Service1, Service2, Service3 Service4, Service 5 and Service 6.

Option: Use thumbstick buttons to operating in option menu as your desire.

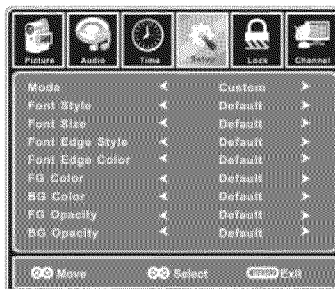

XVS: Activate / deactivate the automatic dynamic brightness function.

Restore Default: Restore all settings in SETUP menu to factory settings.

5. Lock menu

You must enter the password to gain access to the Lock menu. The default password is 0000. You may modify the following options:

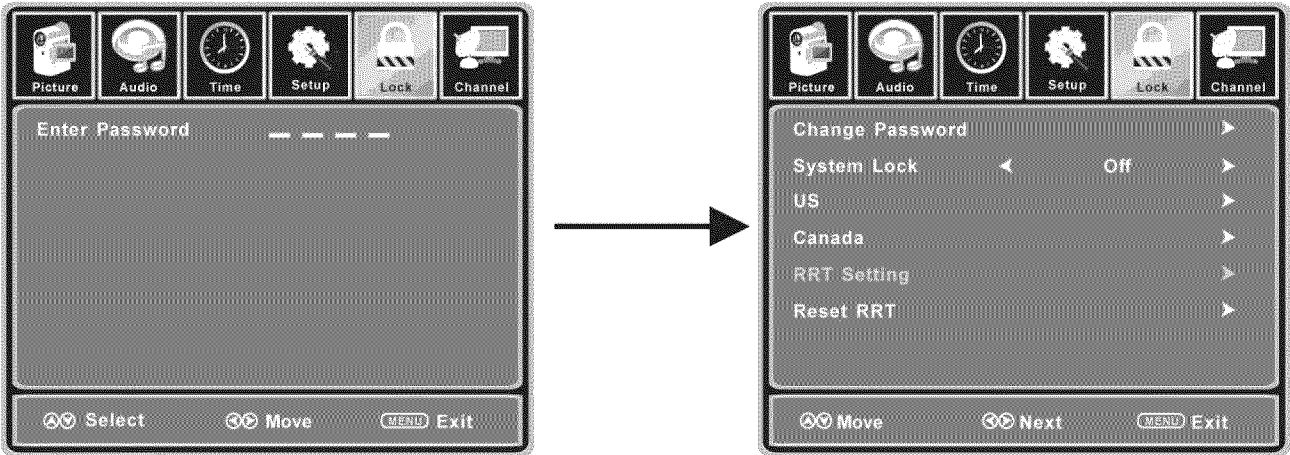

Description

Change password: Change the password, you must enter the new password twice to confirm it. Note: Do not forget the password.

Lock: Allow you to turn on or off the system lock. If deactivated, the functions described below don't work.

This option menu allows you to lock any TV channel or adjust the Movie rating filter.

US: _____

TV: Use ^ / v buttons to select the desired rating and press > button to block or unblock rating.

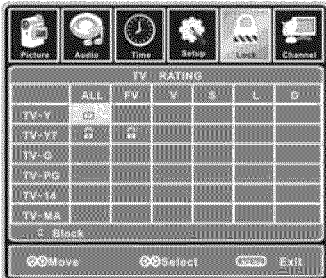

MPAA: The Movie rating (MPAA) is used for original movies rated by the Motion Picture Association of America (MPAA) as broadcasted on cable TV and not edited for television.

Use ^ / v button to select N/A, G, PG, PG-13, R, NC-17 or X.

RATING	DESCRIPTION
G	General Audiences. Movie is appropriate for all ages.
PG	Parental Guidance Suggested. May contain material not suited for younger viewers.
PG-13	Contains content that may not be appropriate for viewers under the age of 13.
R	Restricted. Contains adult content, no one under 17 admitted without parent.
NC-17	No one 17 and under admitted.
X	Adults only.

Canada: _____

Canada English: Select among: E, C, C8+, G, PG, 14+ and 18+.

Canada French: Select among: E, G, 8ans+, 13ans+, 16ans+ and 18ans+.

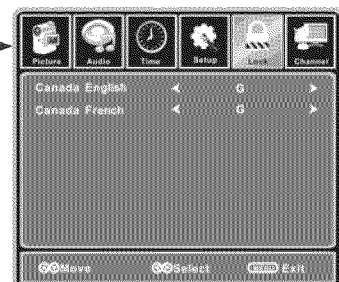

Reset RRT: Allow you to reset the RRT setting.

6. Channel menu

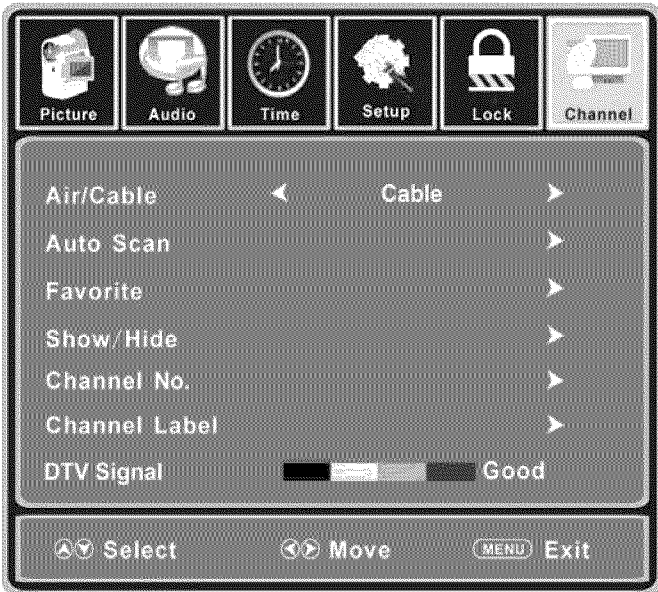

Description

Air/Cable: Allow you to select antenna between Air and Cable.

If you select "Cable", the following items(Favorite, Show/Hide, Channel NO, Channel Label and DTV Signal) are unable to use.

Auto Scan: Enter the Auto Scan menu to start auto scan.

- ★ If you select "Cable" as input signal in Antenna item, allows you to select Cable System among: Auto, STD, IRC and HRC. Use \downarrow button to highlight the "Start to Scan", then press \rightarrow button to search the channels automatically. The receivable channels will be stored automatically. When searching channels, press **MENU** to stop.

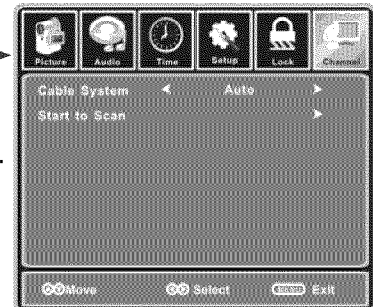

- ★ If you select "Air" as input signal in Antenna item, you can press \rightarrow button to search the channels automatically. The receivable channels will be stored automatically. When searching channels, press **MENU** to stop.
NOTE: It will take a while to auto scan in NTSC or ATSC mode, please wait patiently.

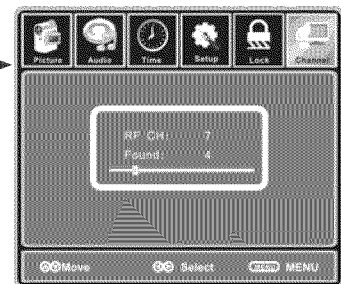

Favorite: Allow you to add these channels which you desired as the favorite channels.

Use \wedge / \vee button to highlight the desired item, then press **OK** button to add or remove the highlighted channel as favorite.



OSD Menu

Show/Hide: Allow you to show or hide the channels.

Use \wedge / \vee button to highlight the desired item, then press **OK** button to show or hide the highlighted channel.

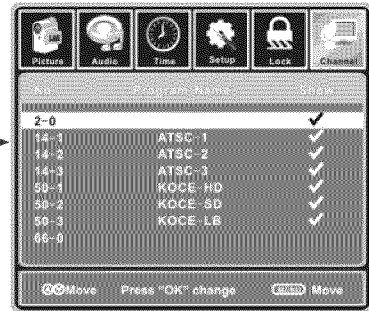

Channel No.: Show and select the channel.

Channel Label: Allow you to setup a label for the channel.

Press $<$ / $>$ button to select the position of the table, and press \wedge / \vee button to select the words.

DTV Signal: Show the quality of digital signal: good, Normal, Bad.

DVD basic operation

Press the Power button on the TV or the remote control, then press the INPUT button to select DVD mode.

Place a disc

Insert a disc with the mirror side facing towards you. If the disc is double sided, place the title you want to play facing you.

Do not touch the playing surface.

Hold the disc around the outside with your fingers and place the disc into the slot. The player will automatically draw the disc into the player.

To "Eject" the disc, press the "**▲** /EJECT" button on the TV or on the remote control.

Play

The contents of each disc vary, as to how the disc was authored and what features are included. Some discs start playing as soon as they have been read, some need "Play" selecting in the Menu. Different play modes are offered, such as Menu Play, Sequence Play and other modes.

Menu Play

1. Compatible with DVD,CD.
2. If the disc is a DVD, ROOT MENU will appear on the screen.
3. When a DVD disc is loaded, press the Arrows buttons to highlight the menu item you want to choose.
4. Press ENTER or Play to start when highlighted.
5. Return to Menu when Playing: When playing a DVD disc press the Menu button to return to the "ROOT" menu.

Title Play

1. Compatible with DVD discs.
2. During DVD playback, press Title button to display the DVD title content.
3. Press the Arrow buttons to highlight the title you want to choose, and press Enter; also you can press numeric buttons to choose.
4. The DVD player begins with the chapter 1 of the chosen title.

Sequence Play

1. Compatible with DVD, CD, HD-CD, WMA, Digital Audio disc.
2. when in stop state, press the Play button, the player will play in the "Sequence" mode.
This is for all compatible discs.

Program Play

1. Compatible with DVD, CD, HD-CD, WMA, Digital Audio disc /JPEG discs.
2. The Program Playback option allows you to enter the order in which you want chapters or tracks to play, maximum to 16.
3. According to the highlight, use the Numeric buttons to enter the chapters / tracks in the order you want them to play. Then press Play or use Arrow buttons to highlight the "PLAY" item and press Enter. The chapters /tracks will play in the programmed order. You can program maximum 16 titles / chapters / tracks.

4. According to the Direction Indicator on the menu, you can press Arrow buttons to highlight where you want to enter.
5. During Program Playback, if program button is repressed, the program order and the contents will be displayed on the screen, and the Program Playback will be stopped; also you can press Stop and Play to resume normal playback.
6. Notes:
 - To clear the program order, use Arrow buttons to highlight the "CLEAR" item, then press Enter.
 - To modify the program order, use Arrow buttons to highlight the item you are changing and enter the new chapter / track you want to program directly.
7. The program indicator in the screen and the playing chapter / track illuminate.

Additional operation

Selecting Tracks

1. Compatible with DVD, CD, HD-CD, WMA, Digital Audio disc /JPEG discs.
2. When playing a DVD disc, press Numeric buttons on the menu or title page to select tracks; During DVD playback, you can input desired title numbers directly.
3. As for CD, HD-CD, discs, press Numeric buttons directly to select tracks.
4. When playing WMA, Digital Audio disc/JPEG discs, press Numeric buttons to select different tracks on current track list.

Skipping Tracks

1. Compatible with DVD,CD, HD-CD, WMA, Digital Audio disc /JPEG discs.
2. To skip forward to the beginning of the next title / chapter / track on a disc, press Next on the remote or the right side of the player.
3. To skip backward to the beginning of the preceding title / chapter/track on a disc, press Prev on the remote or the right side of the player.

Multispeed Fast/Slow Motion Play

1. Compatible with DVD,CD, HD-CD, WMA, Digital Audio disc.
2. Press the Multispeed Fast/Slow button on the remote during play to search through a disc. Multispeed Fast/Slow has four speeds: x2, x4, x8, x20.
With each consecutive press of the button, the search speed increases. If you press the button five times, Fast Multispeed Fast/Slow cycles back to normal play.
3. During DVD play, when Multispeed Fast/Slow gets to the beginning of the next title / chapter, it resumes normal play.

Multiphase Slow Motion Play

1. Compatible with DVD.
2. Multiphase Slow has six speeds: 1/2, 1/3, 1/4, 1/5, 1/6, 1/7 of the normal Speed play when pressing the "Slow" button consecutively when playing discs.
3. When you press Play or the "Slow" button 7 times the player returns to normal play.

Freeze Frame

1. Compatible with DVD,CD, HD-CD, WMA, Digital Audio disc/JPEG discs.
2. During CD, HD-CD, WMA or Digital Audio disc / JPEG playback, press Pause once to freeze playback; Press Play button to resume normal playback.

Using the Repeat Feature

1. Compatible with DVD,CD, HD-CD, WMA, Digital Audio disc /JPEG discs.

2. While a disc is playing, press Repeat button once and the repeat banner appears to show current repeat mode.
 - a) In CD, HD-CD, WMA or Digital Audio disc/JPEG sequence playback mode. Press Repeat button again to turn on repeat mode. Press the button again on the remote to turn to the next repeat mode. There are three repeat options: Off, Track Repeat and Disc Repeat. With each consecutive press of the button, the repeat mode switches. If you press the button four times, repeat mode cycles back to Off.
 - b) In DVD playback, press Repeat button again to turn on repeat mode. There are three repeat options: Off, Chapter Repeat and Title Repeat. With each consecutive press of the button, the repeat mode switches. If you press the button four times, repeat mode cycles back to Off.
 - c) In WMA, Digital Audio disc /JPEG playback, press Repeat button again to turn on repeat mode. There are four repeat options: Off, Track Repeat, Directory Repeat, and Disc Repeat. With each consecutive press of the button, the repeat mode switches. If you press the button five times, repeat mode cycles back to Off.

Using the Display Feature

1. Compatible with DVD, CD, HD-CD, WMA, Digital Audio disc discs.
2. Loading and playing DVDs (two pages)
 - Press DISPLAY button once to show the first page:
 - "Disc Type, Title * / * (the playing title / total titles), Chapter * / * (the playing chapter / total chapters), Elapsed Time of the Disc".
 - Press the button again to show the second page:
 - "Language */* (the serial number of playing language / the amount of optional languages) or Off, Language Type, Audio Type, Subtitle * / * (the serial number of playing subtitle /the amount of optional subtitles) or Off, Angle * / * (the serial number of playing angle / the amount of optional angles) or Off".
 - Press the button for the third time, the display menu fades out.
3. Loading and playing CD, HD-CD, WMA, Digital Audio / JPEG discs
 - Press Display button once to show the first page:
 - "Disc Type, Track * / * (the playing track / total tracks), Mute, Repeat Mode, Elapsed Time of the Playing Track".
 - Press the button again, the display menu fades out.

Using the Search Feature

1. Compatible with DVD, CD, HD-CD discs.
2. You can use Search feature to select a title/ chapter/track number or go to a specific point in a title. First, press GOTO button on the remote controller to bring up the search menu and enter the edit state. Secondly, press Arrow buttons to highlight the title / chapter/ track number or the time option; Thirdly, use Numeric buttons to enter the title / chapter/ track you want to play or the elapsed time you want to go to in that title. At last, press ENTER button to start playback. For example, entering 01:23:56 will start playback one hour, twenty-three minutes and fifty-six seconds into the title.
3. Notes
 - a) This feature does not work in Program Play mode.
 - b) When playing WMA, MP3 / JPEG discs, Search Feature does not work.

Changing the Soundtrack or Language

1. Compatible with DVD, CD, HD-CD, WMA, Digital Audio disc.
2. Press the LANGUAGE button to display current soundtrack.
 - a) Press the button to switch soundtracks.
 - b) Press the button again on the remote to turn to next soundtrack.
3. When playing a CD, HD-CD, WMA, Digital Audio disc, there are three: Stereo (L/R), L/L, and R/R.
4. When playing a DVD disc, press LANGUAGE button to display current language, press the button again to turn to next language if the disc has different languages.

Subtitles

1. Compatible with DVD discs.
2. Press the Subtitle button on the remote once, and the subtitle info banner appears
3. When a DVD is recorded with subtitles, you can use the Subtitle feature to view the subtitles on-screen. By default, subtitles are off. The info banner will display Subtitle Off.
4. To display subtitles, press the Subtitle button again. The default language with its responding serial number will be displayed in the info banner and subtitles will be displayed in that language. There are 8 supported subtitles: Chinese, English, Japanese, French, Spanish, Portuguese, Germany and Latin. With each consecutive press of the Subtitle button, the subtitle switches. For example, "Language Icon: [1 English DTS 6CH] or [Off]" (the availability of the subtitles are disc-dependent). To turn subtitles off, press the Subtitle button until Subtitle Off is displayed.

Mute the Audio Output

1. Compatible with DVD, CD, HD-CD, WMA, Digital Audio disc.
2. Pressing the Mute button allows you to reduce sound to an inaudible level, and the icon of "MUTE" will be displayed on screen. Press the button again or press the Vol +/- button to return to the normal condition.
3. If the player has no sound, check that the "Mute" is not on.

Zoom In the Video Image

1. Compatible with DVD, JPEG discs.
2. The Zoom Function allows you to enlarge the video image.
3. Press Zoom repeatedly to activate the function and choose the required zoom factor: Zoom 2, Zoom 3, Zoom 4, Zoom 1/2, Zoom 1/3, Zoom 1/4, Zoom Off.

Repeat a Specific Segment on the Disc that You Define

1. Compatible with DVD, CD, HD-CD, WMA, Digital Audio disc.
2. During normal or fast playback, press the A-B button once. REPEAT "A" appears on the screen. This indicates the start point of the loop.
3. Press A-B again, REPEAT A-B will be shown, this indicates the end point of the loop.
4. The segment will now be repeated until you press the "REPEAT" button again to turn off the feature.
5. Press A-B again to cancel the loop points.
6. When playing a CD disc, you can repeat a specific segment only in one track. When the next track begins, A-B Repeat turns off automatically.
7. When playing a DVD disc, you can repeat a specific segment only in one title.

Digital Audio Disc

1. Compatible with Digital Audio discs
2. The player will search the disc directory automatically and display the contents on screen.
3. The player will then start to play the first track, of the selected directory.
4. To change directories use the direction buttons.

DVD System Setup

System operation will define the setting of the set; these definitions will be stored until you change them again.

General Steps of Setup Menu

1. Pause or Stop the player. Press **SETUP** on the remote control. The main menu will be shown as below.

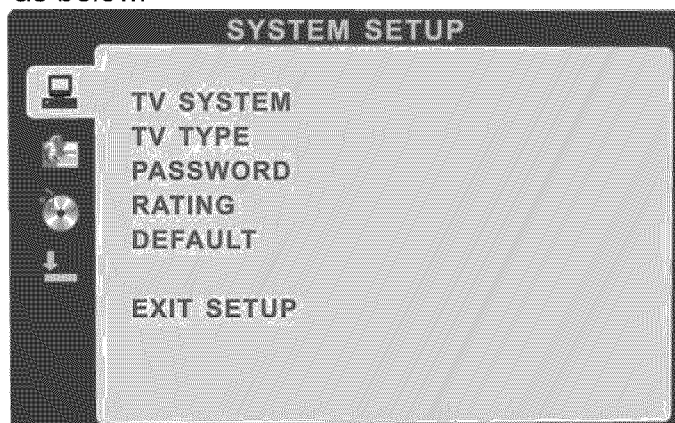

2. Press the \wedge / \vee button to select the Icon of the desired section, e.g. "TV System" and press $\>$ button to open that section.
 3. Press \wedge / \vee to select the desired feature and again press $\>$ button to open that section.
 4. Press \wedge / \vee to select the desired feature and then press "**OK**" to select the new setting.
 - 5 To exit the menu, press "**SETUP**" or \vee button to select EXIT SETUP and then press "**OK**"
- When launching the setup routine, the pressing of the following buttons will turn off the setup menu, while the choices that have been changed will be saved.

Menu specification

1. SYSTEM SETUP

The system setup options are illustrated below:

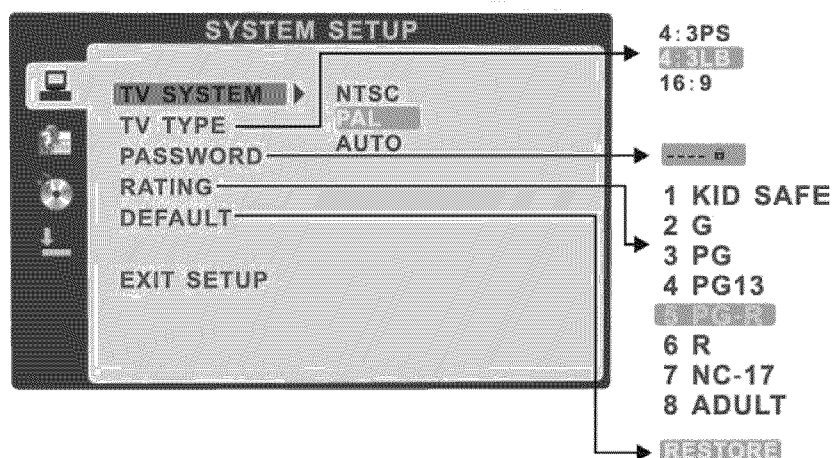

TV SYSTEM

According to the Color system of your TV, select proper TV TYPE.

PASSWORD

The password option is initialized as locked. You cannot set the ratings limit or change the password. To enable these features you must unlock the Password. The default password is

"0000". Using the \wedge / \vee button, move the highlight to "PASSWORD", press \gt the button and enter "0000". You will see the padlock symbol open. You may now change the RATING or put in a new password number. If the Lock symbol is BLUE you must press \gt the button to enter the lock field, the lock symbol will change to YELLOW, you may now enter a new 4 digit number. Please remember or write down the new Password and keep safe.

RATING

The Rating feature is a rating limit feature, like movie ratings. This helps you to control what DVD the family watches. There are 8 levels of selection, from KIDS SAFE to ADULT. Adult is the "play all" selection.

2. LANGUAGE SETUP

The language setup options are illustrated below:



- **OSD LANGUAGE:** The OSD will display in the language you choose.
- **AUDIO LANG:** If the disc you are playing has the language you choose, it will output audio in that language.
- **SUBTITLE LANG:** If the disc you are playing has the language you require you may select this either in the Menu or using the "SUBTITLE" button on the Remote control. You may also switch this OFF.
- **MENU LANG:** If the disc you are playing has the language you require you may select this.

3. AUDIO SETUP

-TONE: Use the \wedge / \vee button to move the scroll and adjust the tone.

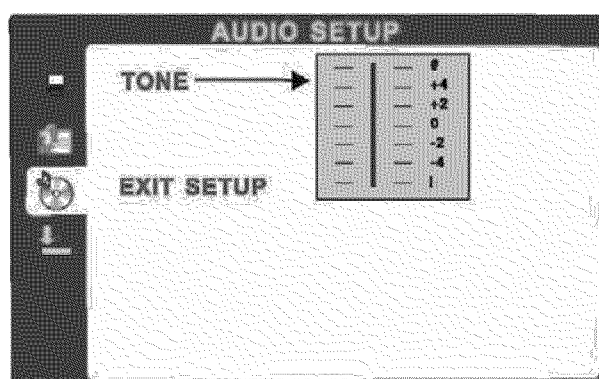

4. DIGITAL SETUP

The video setup options are illustrated below:

- **DYNAMIC RANGE:** Use the \wedge / \vee button to move the scroll and adjust the dynamic range.
- **DUAL MONO:** Choose the mode of the audio output. There are four modes: STEREO, MONO L, MONO R, MIX MONO.

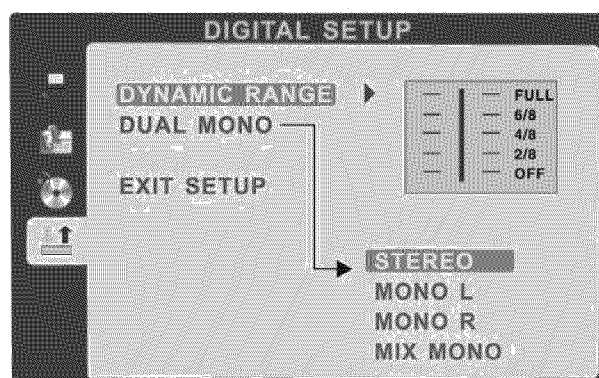

Disc Care

About Disc Terms

Title

Generally, pictures or music compressed on a DVD are divided into several sections, "title".

Chapter

The smaller section unit of picture or music in a DVD under the title, usually one title is comprised of one or more chapters and each of them is numbered for easy searching, but some discs may not have a recording chapter.

Track

A segment of picture or music on a CD, Each track is numbered for searching.

Care of Disc

Video disc contains high-density compressed data that needs proper handling.

1. Hold the disc with fingers by outer edge and/or the center spindle hole. Do not touch the discs surface.
2. Do not bend or press the disc.

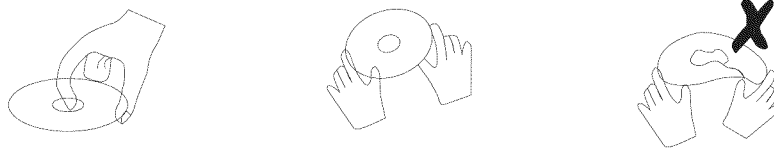

3. Do not expose the disc to direct sunlight or heating sources, Store discs in cabinet vertically, and in dry condition.

Prevent exposure to:

Direct sunlight

Heat or exhaust from a heating device

Extreme humidity

Clean the disc surface with a soft, dry cleaning cloth, Wipe the disc surface gently from center toward the outer edge.

Do not apply thinner, alcohol, chemical solvent, or sprays when cleaning. Such cleaning fluids will permanently damage the disc surface.

Simple Troubleshooting

If the display fails or performance dramatically deteriorates check the Display in accordance with the following instructions. Remember to check the peripherals to pinpoint the source of the failure.

If the display still fails to perform as expected, connect your helpline for assistance.

No power

- Check all connections to the TV.
- Press either the power button or the Standby button on the Remote control.

No picture or sound

- Ensure that the TV is plugged in and the power is on.
- Ensure that the aerial is connected.
- Try a different programme.

Poor picture quality

- Check the aerial connections.
- Check that the channel is tuned in properly.
- Adjust the picture settings: brightness, colour, sharpness, contrast, hue.
- Make sure that the TV is not located close to electrical appliances that may emit radio frequency interference.

No colour

- Adjust the colour setting.
- Check that the programme is broadcast in colour.
- Check that the channel is tuned properly.

TV does not respond to remote control

- Check that there are no obstructions between the remote control and the unit.
- Check that the remote control is within range of the unit.
- Check that the batteries in the remote control are not weak or exhausted.

This LCD TV is for household use and registered as harmless on electromagnetic waves. Therefore, you can use it in every location as well as residential areas.

Technical Specifications

LCD Panel	Panel Size	24 inch (diagonal)
	Brightness	250 cd/m ²
	Contrast	1000:1
	Resolution	1920x1080
Input Connector	Video	1
	Audio(L/R)	1
	VGA	1
	PC Audio	1
	HDMI	2
	YPbPr	1
	RF	1
Output Connector	Coax	1
	Headphone	1
Power Source	DC 12V 5A	
Power Consumption	60W	

* Product specifications and appearance are subject to change without notice.

VIORE™ LIMITED WARRANTY

FLAT PANEL TELEVISION

This **VIORE** brand Product, as supplied and distributed by **VIORE** and delivered new in the original carton to the original purchaser is warranted by **VIORE** against manufacturing defects in materials and workmanship for a limited warranty period of one (1) year on parts and labor. However, there will be only a 90 day parts and labor limited warranty for commercial use.

This Limited Warranty does not apply to store display products and product sold as a "marked down" special, in "as is" condition, "close outs", "liquidation and clearance sales", "open box", products missing accessories, no fault found or damaged at time of delivery to **Viore**.

Proof of purchase within one year from date of purchase in the form of a Bill of Sale, Receipt or Receipted Invoice is evidence the Product is within the limited warranty period. The Bill of Sale, Receipt or Receipted Invoice must be presented as a pre-condition to obtaining the limited warranty service.

This limited warranty begins on the original date of purchase, and is valid only on Products purchased through **VIORE** authorized dealers and used in the United States, Canada, and Puerto Rico by the original purchaser. To receive warranty service, the purchaser must contact **VIORE** for problem determination and service procedures. Warranty service may only be performed by a duly authorized **VIORE** service center. The original dated bill of sale, receipt or receipted invoice must be presented upon request as proof of purchase to **VIORE** or **VIORE's** authorized service center.

VIORE will repair or if repairs cannot be made, **VIORE** will replace this Product at no charge with the same, like or similar Product if the Product is defective as specified in this limited warranty during the limited warranty period. **VIORE** may use new or remanufactured parts or products to repair or replace the Product at its sole discretion. All replaced parts and Products become the property of **VIORE** and must be returned to **VIORE**. Replacement parts and Products assume the remaining original limited warranty, or ninety (90) days, whichever is longer.

Product freight needs to be prepaid by original purchaser and shipped in either its original packaging or packaging affording an equal degree of protection. **VIORE** shall not be responsible for or obligated to replace damaged goods. If you reside in California and you cannot transport the television due to the size, weight, and method of attachment, **VIORE** will provide transportation for the television to the repair facility. If you reside in a state other than California, you are responsible for the costs of transporting the television to a repair facility.

If the product is received damaged by **VIORE**, it is the responsibility of the consumer to file a claim against the carrier. **VIORE** will only store the damaged product for 30 days and reserves the right, in its sole discretion, to dispose of the damaged product or ship it back to the consumer at consumer's expense after 30 days.

This limited warranty covers manufacturing defects in materials and workmanship encountered in normal, and except to the extent otherwise expressly provided for in this statement, noncommercial use of this product, and shall not apply to the following, including, but not limited to: Damage which occurs in shipment; delivery and installation; applications and uses for which this product was not intended; altered product or serial numbers; cosmetic damage or exterior finish; accidents, abuse, neglect, fire, water, lightning or other acts of nature; use of products, equipment, systems, utilities, services, parts, supplies, accessories, applications, installations, repairs, external wiring or connectors not supplied or authorized by **VIORE** which damage this product or result in service problems; incorrect electrical line voltage, fluctuations and surges; customer adjustments and failure to follow operating instructions, cleaning, maintenance and environmental instructions that are covered and prescribed in the instruction book; reception problems and distortion related to noise, echo, interference or other signal transmission and delivery problems; burned-in images. **VIORE** does not warrant uninterrupted or error-free operation of the product.

THERE ARE NO EXPRESS OR IMPLIED WARRANTIES OTHER THAN THOSE LISTED AND DESCRIBED ABOVE, AND NO WARRANTIES WHETHER EXPRESS OR IMPLIED, INCLUDING, BUT NOT LIMITED TO, ANY IMPLIED WARRANTIES OF MERCHANTABILITY OR FITNESS FOR A PARTICULAR PURPOSE, SHALL APPLY AFTER THE EXPRESS WARRANTY PERIODS STATED ABOVE, AND NO OTHER EXPRESS WARRANTY OR GUARANTY GIVEN BY ANY PERSON, FIRM OR CORPORATION WITH RESPECT TO THIS PRODUCT SHALL BE BINDING ON VIORE. REPAIR OR REPLACEMENT AS PROVIDED UNDER THIS LIMITED WARRANTY IS THE EXCLUSIVE REMEDY OF THE CONSUMER. VIORE SHALL NOT BE LIABLE FOR ANY INCIDENTAL, OR CONSEQUENTIAL DAMAGES FOR BREACH OF ANY EXPRESS OR IMPLIED WARRANTY ON THIS PRODUCT; EXCEPT TO THE EXTENT PROHIBITED BY APPLICABLE LAW, ANY IMPLIED WARRANTY OF MERCHANTABILITY OR FITNESS FOR A PARTICULAR PURPOSE ON THIS PRODUCT IS LIMITED FOR THE DURATION OF THIS LIMITED WARRANTY. THIS LIMITED WARRANTY SHALL NOT EXTEND TO ANYONE OTHER THAN THE ORIGINAL PURCHASER OF THIS PRODUCT, IS NONTRANSFERABLE AND STATES YOUR EXCLUSIVE REMEDY.

Some states do not allow limitations on how long an implied warranty lasts, or the exclusion or limitation of incidental or consequential damages, so the above limitations or exclusions may not apply to you. This warranty gives you specific legal rights, and you may also have other rights which vary from state to state. Any provision contained herein which is found contrary to state or local laws shall be deemed null and void and the remaining provisions shall continue in full force and effect.

To obtain warranty service, please contact **VIORE** at:

Phone: 1-877-777-1428 (USA / Puerto Rico)
1-877-777-1429 (Canada)
www.viore.com

