

# Operator's Manual

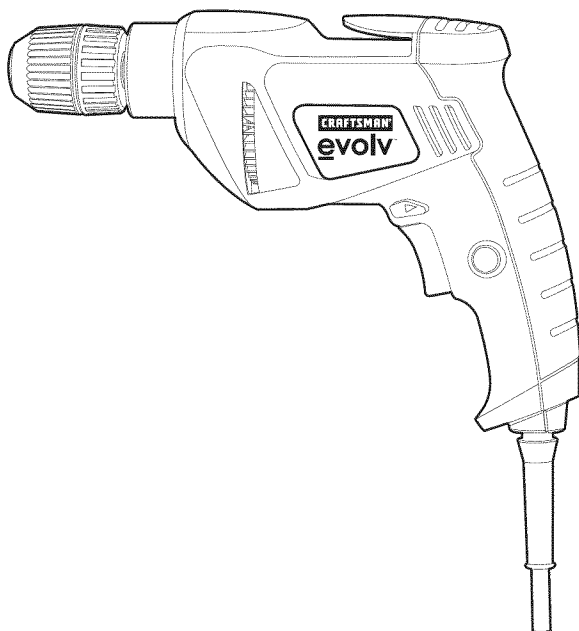

## 3/8" Keyless Drill

Model No. 320.17217



**▲ WARNING:** To reduce the risk of injury, the user must read and understand the **Operator's Manual** before using this product.

- WARRANTY
- SAFETY
- ASSEMBLY
- DESCRIPTION
- OPERATION
- MAINTENANCE

Sears Brands Management Corporation

[www.craftsman.com](http://www.craftsman.com)

## TABLE OF CONTENTS

Warranty	Page 2
Safety Symbols	Page 3
Safety Instructions	Pages 4-7
Unpacking	Pages 8
Description	Pages 8-10
Operation	Pages 10-13
Maintenance	Page 14
Troubleshooting	Page 15
Parts List	Pages 16-17
Sears Repair Parts Phone Number	Back Cover

### **CRAFTSMAN® EVOLV FULL WARRANTY**

If this Craftsman® Evolv product fails due to a defect in material or workmanship within one year from the date of purchase, return it to any Sears store or other Craftsman® Evolv outlet in the United States for free replacement.

This warranty is void if this product is ever used for commercial or rental purposes.

This warranty gives you specific legal rights, and you may also have other rights which vary from state to state.

Sears, Roebuck and Co., Hoffman Estates, IL 60179

**⚠ WARNING:** Some dust created by using power tools contains chemicals known to the state of California to cause cancer and birth defects or other reproductive harm.

**SAVE THESE INSTRUCCIONES!**  
**READ ALL INSTRUCTIONS!**

## SAFETY SYMBOLS

The purpose of safety symbols is to attract your attention to possible dangers. The safety symbols and the explanations with them deserve your careful attention and understanding. The symbol warnings do not, by themselves, eliminate any danger. The instructions and warnings they give are no substitutes for proper accident prevention measures.

**⚠ WARNING:** Be sure to read and understand all safety instructions in this manual, including all safety alert symbols, such as “**DANGER,**” “**WARNING,**” and “**CAUTION,**” before using this keyless drill. Failure to following all instructions listed below may result in electric shock, fire and/or serious personal injury.

### SYMBOL MEANNING

**⚠ SAFETY ALERT SYMBOL:** Indicates **DANGER, WARNING, OR CAUTION.** May be used in conjunction with other symbols or pictographs.

**⚠ DANGER:** Failure to obey this safety warning will result in death or serious injury to yourself or to others. Always follow the safety precautions to reduce the risk of fire, electric shock, and personal injury.

**⚠ WARNING:** Failure to obey this safety warning can result in death or serious injury to yourself or to others. Always follow the safety precautions to reduce the risk of fire, electric shock, and personal injury.

**⚠ CAUTION:** Failure to obey this safety warning may result in death or serious injury to yourself or to others. Always follow the safety precautions to reduce the risk of fire, electric, shock and personal injury.

### DAMAGE PREVENTION AND INFORMATION MESSAGES

These inform user of important information and/or instructions that could lead to equipment or other property damage if not followed. Each message is preceded by the word “**NOTE**” as in the example below.

**NOTE:** Equipment and/or property damage may result if these instructions are not followed.

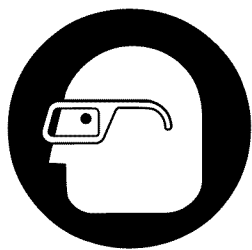

The operation of any power tool can result in foreign objects being thrown into your eyes, which can result in severe eye damage. Before beginning power tool operation, always wear safety goggles or safety glasses with side shields and a full-face shield when needed. We recommend a Wide Vision Safety Mask for use over eyeglasses or standard safety glasses with side shields, available at Sears Stores or other Craftsman outlets. Always use eye protection that is marked to comply with ANSI Z87.1

## SAFETY INSTRUCTIONS

**⚠ WARNING:** Be sure to read and understand all instructions in this manual before using the drill. Failure to follow all instructions may result in hazardous radiation exposure, electric shock, fire, and/or serious personal injury.

**⚠ WARNING:** Do not attempt to operate this tool until you have thoroughly read all instructions, safety rules, and warnings. Failure to comply with them can result in fire, electric shock, or serious personal injury. Save the manual and refer to it frequently.

### GENERAL SAETY PRECAUTIONS

#### WORK AREA SAFETY

- **Keep work area clean and well lit.** Cluttered or dark areas invite accidents.
- **Do not operate power tools in explosive atmospheres, such as in the presence of flammable liquids, gases or dust.** Power tools create sparks which may ignite the dust or fumes.
- **Keep children and bystanders away while operating a power tool.** Distractions cause you to lose control.

#### ELECTRICAL SAFETY

- **Double insulated tools are equipped with a polarized plug (one blade is wider than the other.) This plug will fit in a polarized outlet only one way. If the plug does not fit fully in the outlet, reverse the plug. If it still does not fit, contact a qualified electrician to install a polarized outlet. Do not change the plug in any way.** Double insulation eliminates the need for the three wire grounded power cord and grounded power supply system.
- **Avoid body contact with grounded surfaces such as pipes, radiators, ranges and refrigerators.** There is an increased risk of electric shock if your body is grounded.
- **Don't expose power tools to rain or wet conditions.** Water entering a power tool will increase the risk of electric shock.
- **Do not abuse the cord. Never use the cord to carry the tools or pull the plug from an outlet. Keep cord away from heat, oil, sharp edges or moving parts. Replace damaged cords immediately.** Damaged cords increase the risk of electric shock.
- **When operating a power tool outside, use an outdoor extension cord marked "W-A" or "W".** These cords are rated for outdoor use and reduce the risk of electric shock. The following table shows the correct size to use, depending on cord length and nameplate amperage rating of the tool.

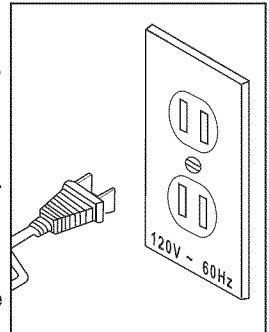

When in doubt, use the next heavier gauge. Always use UL and CSA listed extension cords.

### Recommended sizes of extension cords

Ampere Rating		Volts	Total Length of Cord in feet			
		120v	25ft	50ft	100ft	150ft
More Than	Not More Than	AWG				
0	6		18	16	16	14
6	10		18	16	14	12
10	12		16	16	14	12
12	16		14	12	Not Recommended	

### PERSONAL SAFETY

- **Stay alert, watch what you are doing and use common sense when operating a power tool. Do not use tool while tired or under the influence of drugs, alcohol, or medication.** A moment of inattention while operating power tools may result in serious personal injury.
- **Dress properly. Do not wear loose clothing or jewelry. Contain long hair. Keep your hair, clothing, and gloves away from moving parts.** Loose clothes, jewelry, or long hair can be caught in moving parts.
- **Avoid accidental starting. Be sure switch is off before plugging in.** Carrying tools with your finger on the switch or plugging in tools that have the switch on invites accidents.
- **Remove adjusting keys or wrenches before turning the tool on.** A wrench or a key that is left attached to a rotating part of the tool may result in personal injury.
- **Do not overreach. Keep proper footing and balance at all times.** Proper footing and balance enables better control of the tool in unexpected situations.
- **Use safety equipment. Always wear eye protection.** Dust mask, non-skid safety shoes, hard hat, or hearing protection must be used for appropriate conditions.
- **Before connecting the tool to a power source (receptacle, outlet, etc.), be sure voltage supplied is the same as that specified on the nameplate of the tool.** A power source with voltage greater than that specified for the tool can result in serious injury to the user – as well as damage to the tool.

### TOOL USE AND CARE

- **Use clamps or other practical way to secure and support the workpiece to a stable platform.** Holding the work by hand or against your body is

unstable and may lead to loss of control.





- **Do not force tool. Use the correct tool for your application.** The correct tool will do the job better and more safely at the rate for which is designed.
- **Do not use tool if the switch does not turn it on or off.** Any tool that cannot be controlled with the switch is dangerous and must be repaired.
- **Disconnect the plug from the power source before making any adjustments, changing accessories, or storing the tool.** Such preventive safety measures reduce the risk of starting the tool accidentally.
- **Store idle tools out of reach of children and other untrained persons.** Tools are dangerous in the hands of untrained users.
- **Maintain tools with care. Keep cutting tools sharp and clean.** Properly maintained tools, with sharp cutting edges are less likely to bind and are easier to control.
- **Check for misalignment or binding of moving parts, breakage of parts, and any other condition that may affect the tools operation. If damaged, have the tool serviced before using.** Many accidents are caused by poorly maintained tools.
- **Use only accessories that are recommended by the manufacturer for your model.** Accessories that may be suitable for one tool, may become hazardous when used on another tool.
- **Do not alter or misuse tool.** These tools are precision built. Any alteration or modification not specified is misuse and may result in a dangerous condition.

## **SERVICE**

- **Tool service must be performed only by qualified repair personnel.** Service or maintenance performed by unqualified personnel could result in a risk of injury.
- **When servicing a tool, use only identical replacement parts. Follow instructions in the Maintenance section of this manual.** Use of unauthorized parts or failure to follow Maintenance instructions may create a risk of shock or injury.

## SAFETY SYMBOLS FOR YOUR TOOL

The label on your tool may include the following symbols.

V.....	Volts
A.....	Amps
Hz.....	Hertz
W.....	Watts
min.....	Minutes
 .....	Alternating Current
 .....	Direct Current
no .....	No-load Speed
 .....	Class II construction
.../min.....	Revolutions or Strokes per minute
 .....	Indicates danger, warning caution. It means attention! Your safety is involved.

## SPECIFIC SAFETY RULES FOR DRILL

 **DANGER:** Keep hands away from drilling area and drill bit. Do not reach under the material being drilled.

Always keep your body positioned to either side of the drill, but not in line with the drill bit.

- Do not reach underneath the work.
- Always clamp workpiece before drilling. Never hold a workpiece in your hand or legs. Small or thin material may flex or vibrate with the drill bit, causing loss of control.
- Never touch the drill bit after use. It may be hot after prolonged use.
- Always hold tool by insulated gripping surfaces when performing an operation where the tool may contact hidden wiring or its own cord. Contact with a “live” wire will make the exposed metal parts of the tool “live” and shock the operator.
- Always use drill bits that are of a correct size and shape. Drill bits that do not fit the chuck jaws of the electric drill will perform erratically and will cause loss of control.
- Always be sure that all chuck adjustments have been made and that the drill bit is fastened tightly before drilling. Loose drill can cause the tool to slip, and loss of control may result.

 **WARNING:** To reduce the risk of injury, user must read instruction manual.

## UNPACKING

**⚠ WARNING:** Your drill should never be connected to the power source when you are assembling parts, making adjustments, installing or removing bits, cleaning it, or when it is not in use. Disconnecting the drill will prevent accidental starting, which could cause serious personal injury.

When unpacking the box, do not discard any packing materials until all of the contents are accounted for:

1. Carefully lift the drill out of the carton and place it on a stable, flat surface.
2. Open the color box to locate the following:
  - 1 drill
  - Operator's manual
3. Inspect the items carefully to make sure that no breakage or damage has occurred during shipping. If any of the items mentioned is missing, (refer to "PARTS LIST" illustration), return the drill to your nearest Sears store or Craftsman outlet to have the drill replaced. Carefully remove the tool and any accessories from the box. Make sure that all items listed in the packing list are included.

**⚠ WARNING:** If any part is broken or missing, do not attempt to assemble the drill, plug in the power cord, or operate the drill until the broken or missing part has been replaced. Failure to do so could result in possible serious injury.

### CARTON CONTENTS/LOOSE PARTS (Fig. 1)

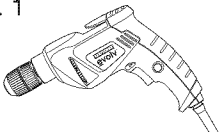
Fig. 1 	Drill	1
--	-------	---

## DESCRIPTION

### KNOW YOUR DRILL (Fig.2)

Before attempting to use this drill, familiarize yourself with all its operating features and safety requirements.

**⚠ WARNING:** Do not allow familiarity with your drill to make you careless. Remember that a careless fraction of a second is sufficient to inflict severe injury.



Fig. 2

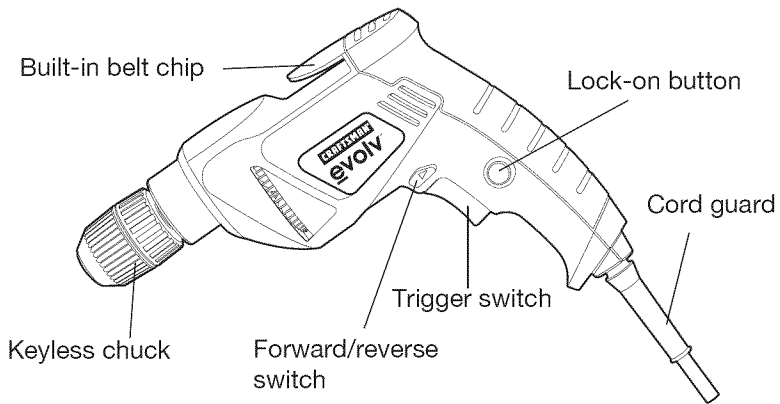

### PRODUCT SPECIFICATIONS

Motor	120V~60Hz, 5.2A
No Load Speed	0-2500 (RPM)
Chuck	3/8" (10mm)
Cord length	6'
Weight	3.1lbs

**⚠ WARNING:** The safe use of this product requires an understanding of the information on the tool and in this operator's manual as well as knowledge of the project you are attempting. Before use of this product, familiarize yourself with all operating features and safety rules.

#### **VARIABLE-SPEED TRIGGER SWITCH**

To start the drill, press the trigger switch. To stop the drill, release the trigger switch.

The variable-speed trigger switch delivers higher speed with increased trigger pressure and lower speed with decreased trigger pressure.

#### **LOCK-ON BUTTON**

Squeeze the trigger switch and depress the "Lock-on" button.

#### **FORWARD/REVERSE SWITCH**

To use the drill in the forward position, push the switch to the left. To use the drill in the reverse position, push the switch to the right.

#### **KEYLESS CHUCK**

For quick and easy bit changes.

## CORD GUARD

Protects the cord from bending to prevent damage.

## BUILT-IN BELT CLIP

Conveniently hooks onto your tool belt for carrying the drill.

**NOTE:** Make sure the plug has been removed from power supply and drill bits have been removed from drill. Your drill comes equipped with variable speeds, which can be adjusted by using the 2-finger trigger switch.

- Low-speed range for drilling in hard materials such as steel
- High-speed range for drilling in soft materials

**⚠ WARNING:** Disconnect the tool from the power supply before installing or removing a drill bit.

**⚠ CAUTION:** To prevent gear damage, always allow the chuck to come to a complete stop before changing the direction of rotation.

## OPERATION

**⚠ WARNING:** Always wear safety goggles or safety glasses with side shields when operating your electric drill. Failure to do so could result in foreign objects being thrown into your eyes resulting in possible serious eye damage.

**⚠ WARNING:** Always wear an appropriate dust mask and hearing protection when using your electric drill.

**⚠ WARNING:** Clamp or otherwise secure your workpiece to prevent it from moving under the drill while being drilled. An unsecured workpiece could be thrown toward the operator causing injury.

## FORWARD/REVERSE SWITCH (Fig. 3)

Your drill is reversible. The forward/reverse switch is conveniently mounted above the trigger switch.

To make the drill rotate clockwise (for drilling), push the forward/reverse switch to the left.

To make the drill rotate counterclockwise to remove screws, push the forward/reverse switch to the right.

**Note:** Never change position of

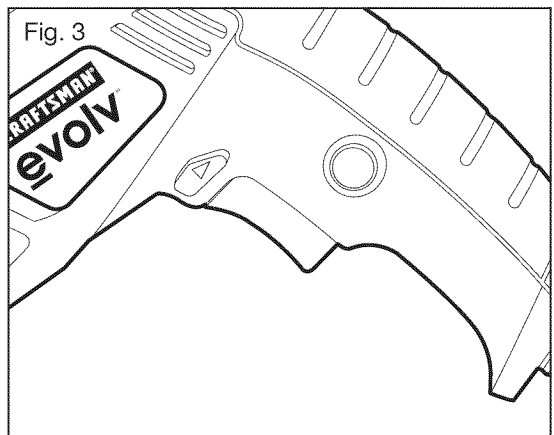

the forward/reverse switch while the chuck is turning.

**⚠ WARNING:** Always disconnect your drill from the power source when replacing drill bits, tools, cleaning or when it is not in use. Disconnecting the drill will prevent accidental starting that could cause serious personal injury.

### INSTALLING DRILL BITS AND ACCESSORIES (Fig.4)

1. Unplug your drill.

**⚠ WARNING:** Failure to unplug the drill could result in accidental starting causing possible serious personal injury.

2. With one hand on the rear of the chuck, use the other hand to rotate the front sleeve of the chuck to open the chuck jaws so that the opening is slightly larger than the shaft of the drill bit you intend to use. Raise the front of your drill slightly to prevent the drill bit you will insert from falling out of the chuck jaws.

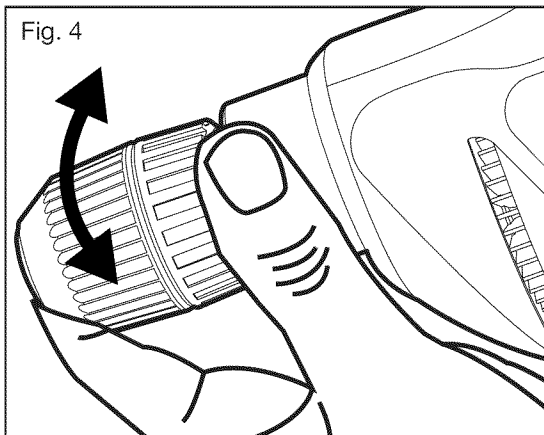

3. Insert the drill bit into the chuck jaws as far as it can go.
4. Rotate the chuck clockwise (when the chuck is facing toward you) until the drill bit is held firmly in place by the chuck jaws.

**⚠ WARNING:** The drill bit must be properly inserted, with all three chuck jaws holding the bit centered in the chuck. Failure to properly insert the drill bit could cause the drill bit to be thrown from the chuck during operation, resulting in possibly serious injury or damage to the chuck.

**⚠ WARNING:** Always disconnect your drill from the power source when replacing drill bits or tools, cleaning it, or when not in use. Disconnecting the drill will prevent accidental starting that could cause serious personal injury.

### REMOVING DRILL BITS AND ACCESSORIES (Fig. 4)

1. Unplug your drill.

**⚠ WARNING:** Failure to unplug the drill could result in accidental starting causing possibly serious personal injury.

2. With one hand on the rear of the chuck, use another hand to rotate the front sleeve of chuck to open the chuck jaws to release the drill bit.
3. Remove the drill bit.

**⚠ WARNING:** Every time you use the drill, be sure to verify the following:

- Chuck jaws are tight and securing the drill bit firmly.
- Drill power cord is not damaged.
- Drill bit is the correct type for the material being drilled.
- Drill bit is in good condition, properly installed and securely tightened.
- Safety glasses and dust mask are being worn.

Failure to follow these safety rules can greatly increase your chances of injury!

### GENERAL DRILLING TIPS (Fig.5)

**⚠ WARNING:** Keep hands and fingers away from the area between the motor housing and chuck. Do not reach underneath the workpiece while drill is operating.

You can use your drill with various materials, such as soft and hard wood, plywood, plastics, metals, ceramics, laminates and masonry. Be sure your drill bit is specified for use with the respective materials.

You can also use your drill with a variety of accessories, such as buffing wheels, sanding drums, wire wheels, hole saws and other accessories specified for use with electric power drills.

When drilling in smooth, hard surfaces (such as metal and hardwoods), use a center punch (sold separately) to mark the desired hole location. This will prevent the drill bit from slipping off center as the hole is started. The workpiece to be drilled should be secured in a vise or clamped to a work surface to keep it from turning as the drill bit rotates (Fig. 5).

**⚠ CAUTION:** Do not force the drill bit against the material you are drilling. The motor may overheat and break the drill bit. If the drill bit breaks, it must be replaced with a new drill bit.

**⚠ WARNING:** Always clamp the workpiece to a stable surface. Failure to clamp the workpiece could result in the workpiece being thrown or kicked back, causing serious personal injury.

1. Check the drill bit to make sure it is firmly locked in the chuck jaws of the drill.
2. Check that the forward/reverse switch is in the forward position.
3. Hold the drill firmly with both hands whenever possible. Use one hand to

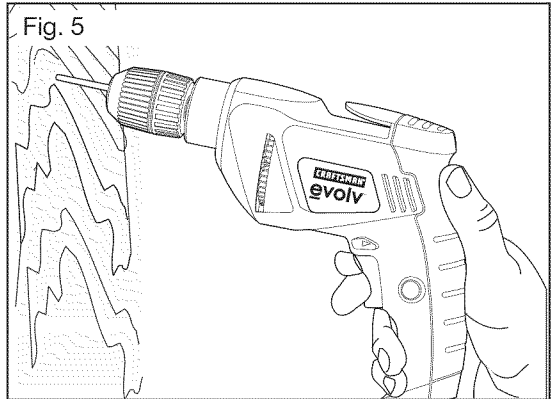

grasp the handle and trigger switch and the other to grasp the body of the drill.

**NOTE:** Make sure that the hand placed on the body of the drill does not cover the air vents. Covering the air vents will reduce motor cooling and possibly lead to motor overheating.

4. Holding the drill firmly, place the point of the drill bit at the point to be drilled. Squeeze the trigger to start the drill.
5. Move the drill bit into the workpiece, applying only enough pressure to keep the bit cutting. Let your drill and the drill bit do the work. Do not force the drill bit or apply sideways pressure which will elongate the hole.

**⚠ WARNING:** Be prepared for drill bit binding or breakthrough. When these situations occur, the drill bit tends to grab the workpiece and kick the drill in the opposite direction of the drill bit rotation. If you are not prepared, the resulting loss of control when binding or breaking through the material could result in possibly serious injury.

When drilling metals, use light oil on the drill bit to keep it from overheating. The oil will prolong the life of the drill bit and enhance drill bit cutting action. If the drill bit jams in the workpiece or if the drill stalls, immediately release the trigger switch. Remove the drill bit from the workpiece and determine the cause of the jamming.

**⚠ WARNING:** Always disconnect your drill from the power source when replacing drill bits, tools, cleaning or when not in use. Disconnecting the drill will prevent accidental starting that could cause serious personal injury.

## MAINTENANCE

**⚠ WARNING:** To ensure safety and reliability, all repairs should be performed by a qualified service technician at a Sears store or other Craftsman Evolv outlet.

**⚠ WARNING:** For your safety, always turn off the switch and disconnect the plug from the electrical outlet before performing any maintenance or cleaning.

Periodic maintenance of your drill allows for long life and trouble free operation. A cleaning, lubrication, and maintenance schedule should be maintained.

As a common-sense and preventive maintenance practice, follow these recommended steps:

- Inspect the bit; check the rim for wear or damage.
- Use a soft clean and damp cloth to wipe the tool housing. A mild detergent can be used but nothing like alcohol, gasoline or other cleaning agents. Never use caustic agents to clean plastic parts.
- Keep the ventilation slots of the motor clean to prevent overheating of the motor. Electric tools are subject to accelerated wear and possible premature failure when they are used to work on fiberglass boats and sports cars, wallboard, spackling compounds or plaster. The chips and grindings from these materials are highly abrasive to electrical tool parts, such as bearings, brushes, commutators, etc. Consequently, it is not recommended that this tool be used for extended work on any fiberglass material, wallboard, spackling compound, or plaster. During any use on these materials, it is extremely important that the tool is cleaned frequently by blowing with an air jet.

**⚠ WARNING:** Always wear safety goggles or safety glasses with side shields during power tool operations or when blowing dust. If operation is dusty, also wear a dust mask.

**⚠ WARNING:** Keep the tool's air vents unclogged and clean at all times.

**⚠ WARNING:** Avoid using solvents when cleaning plastic parts. Most plastics are susceptible to damage from various types of commercial solvents and may be damaged by their use. Use clean cloths to remove dirt, dust, oil, grease, etc.

**⚠ WARNING:** Do not at any time let brake fluids, gasoline, petroleum-based products, penetrating oils, etc. to come in contact with plastic parts. Chemicals can damage, weaken or destroy plastic which may result in serious personal injury.

**⚠ WARNING:** Water must never come into the tool.

## TROUBLE SHOOTING

<b>PROBLEM</b>	<b>CAUSE</b>	<b>SOLUTION</b>
The drill does not start when trigger switch is squeezed	Check to be sure power cord is connected to power source and that power source (outlet) is operable	Connect to power source. Confirm power source (outlet) is operable
Will not drill	Check drill bit and chuck jaws	Replace drill bit if dull or worn; tighten chuck jaws to firmly secure drill bit
Motor overheating	Be sure cooling vents are free from dust and obstacles	Clean, clear vents. Do not cover with hand during operation

# PARTS LIST

3/8" Keyless Drill MODEL NUMBER 320.17217

Always mention the Model Number when ordering parts for this tool

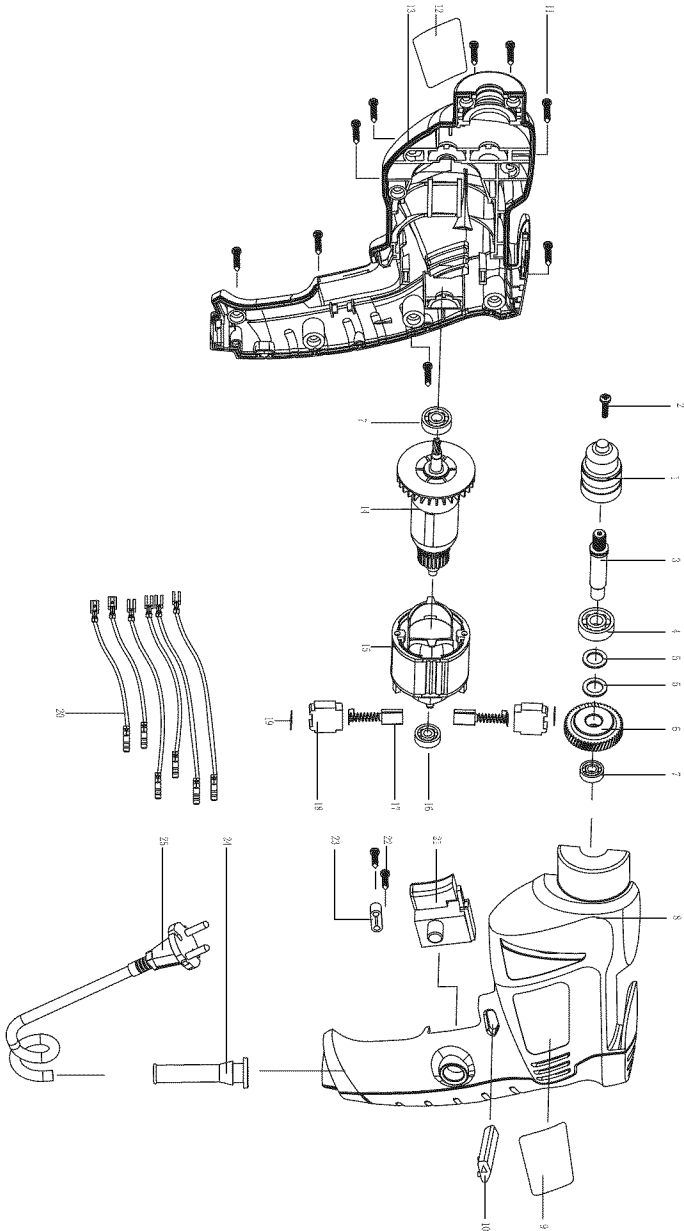



## PARTS LIST

No	Part No	Part Name	QTY
1	3860001000	Chuck	1
2	5620179000	Screw (L.H.)	1
3	3550093000	Spindle	1
4	5700015000	Ball Bearing	1
5	3520013000	Septa	2
6	3520016000	Gear	1
7	5700008000	Ball Bearing	2
8	3320036000	Left Housing	1
9	2240066000	Name Plate	1
10	3120245000	F/R Button	1
11	5610042000	Tapping Screw	9
12	2240073000	Name Plate	1
13	3320035000	Right Housing	1
14	2750119000	Rotor	1
15	2740100000	Stator	1
16	5700004000	Ball Bearing	1
17	4960015000	Carbon Brush	2
18	2800015000	Brush Holder	2
19	3700491000	Flash Board	2
20	2820717000	Internal Wire ASSY 1-6	1
	2820718000		1
	2820720000		1
	2820722000		1
	2820724000		1
	2820726000		1
21	4870024000	Switch	1
22	5610023000	Tapping Screw	2
23	3700285000	Cord Anchorage	1
24	3121001000	Cord Guard	1
25	4810002000	Power Cord & Plug	1

## NOTE

**NOTE**

# Get it fixed, at your home or ours!

## Your Home

For expert troubleshooting and home solutions advice:

**manage my home**

[www.managemyhome.com](http://www.managemyhome.com)

For repair – **in your home** – of **all** major brand appliances, lawn and garden equipment, or heating and cooling systems, **no matter who made it, no matter who sold it!**

For the replacement parts, accessories and owner's manuals that you need to do-it-yourself.

For Sears professional installation of home appliances and items like garage door openers and water heaters.

**1-800-4-MY-HOME®**

(1-800-469-4663)

[www.sears.com](http://www.sears.com)

Call anytime, day or night

(U.S.A. and Canada)

[www.sears.ca](http://www.sears.ca)

## Our Home

For repair of carry-in items like vacuums, lawn equipment, and electronics, call anytime for the location of the nearest **Sears Parts & Repair Service Center**

**1-800-488-1222** (U.S.A.)

[www.sears.com](http://www.sears.com)

**1-800-469-4663** (Canada)

[www.sears.ca](http://www.sears.ca)

To purchase a protection agreement on a product serviced by Sears:

**1-800-827-6655** (U.S.A.)

**1-800-361-6665** (Canada)

Para pedir servicio de reparación a domicilio, y para ordenar piezas:

**1-888-SU-HOGAR®**

(1-888-784-6427)

Au Canada pour service en français:

**1-800-LE-FOYER<sup>MC</sup>**

(1-800-533-6937)

[www.sears.ca](http://www.sears.ca)

# Sears

© Sears Brands, LLC

® Registered Trademark / <sup>TM</sup> Trademark / <sup>SM</sup> Service Mark of Sears Brands, LLC

® Marca Registrada / <sup>TM</sup> Marca de Fábrica / <sup>SM</sup> Marca de Servicio de Sears Brands, LLC

<sup>MC</sup> Marque de commerce / <sup>MD</sup> Marque déposée de Sears Brands, LLC