

**32" TFT LCD DIGITAL TV WITH DVD PLAYER
TÉLÉVISEUR NUMÉRIQUE AVEC ÉCRAN TFT À CRISTAUX
LIQUIDES DE 32 PO ET LECTEUR DVD**

**HDLCDVD325
HDLCDVD325A**

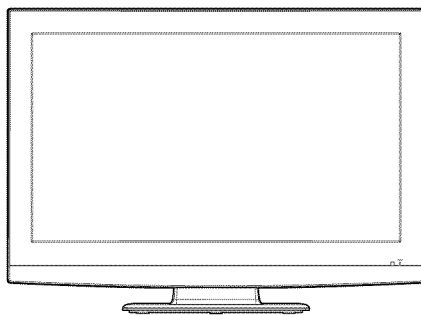

**ATTENTION
ATTENTION**

If you purchase a universal remote control from your local retailer, please contact the remote manufacturer for the required programming code.

Si vous utilisez avec cet appareil une télécommande universelle (autre que celle vendue avec ce téléviseur), consultez la documentation accompagnant la télécommande universelle afin de connaître le code numérique correspondant au téléviseur.

**AIR/CABLE MODE SELECTION
SÉLECTION DU MODE AIR/CABLE**

When shipped from the factory, the Signal Type option is set to the "Cable" (Cable Television) mode.

If not using Cable TV, set this menu option to the "Air" position.

Lorsque l'appareil sort de l'usine, l'option « Signal Type » est en mode « Cable » (câblodistribution). Si vous n'utilisez pas la câblodistribution, sélectionnez l'option « Air ».

**IF CONTACT WITH CUSTOMER SERVICE IS REQUIRED
PLEASE HAVE THE MODEL NUMBER READY PRIOR TO THE CALL
S'IL FAUT CONTACTER LE SERVICE CLIENTÈLE, PRENEZ SOIN D'ÊTRE MUNI
DU NUMÉRO DE MODÈLE AVANT D'APPELER.**

**CUSTOMER SERVICE - 1-800-289-0980
SERVICE/SERVICE CLIENTÈLE: 1-800-289-0980**



**ORION WEBSITE
SITE WEB ORION**

**FOR INFORMATION ON OUR OTHER PRODUCTS, PLEASE VISIT OUR WEBSITE AT
POUR OBTENIR DES INFORMATIONS SUR NOS AUTRES PRODUITS, VEUILLEZ VISITER NOTRE SITE WEB:**

www.orionsalesinc.com

Before operating the unit, please read this manual thoroughly.
Avant de faire fonctionner l'appareil, veuillez lire le présent guide attentivement.

ENGLISH

	CAUTION RISK OF ELECTRIC SHOCK DO NOT OPEN	
CAUTION: TO REDUCE THE RISK OF ELECTRIC SHOCK, DO NOT REMOVE COVER (OR BACK). NO USER-SERVICEABLE PARTS INSIDE. REFER SERVICING TO QUALIFIED SERVICE PERSONNEL.		



The lightning flash with arrowhead symbol, within an equilateral triangle is intended to alert the user to the presence of uninsulated dangerous voltage within the product's enclosure that may be of sufficient magnitude to constitute a risk of electric shock.



The exclamation point within an equilateral triangle is intended to alert the user to the presence of important operating and maintenance (servicing) instructions in the literature accompanying the appliance.

WARNING: TO PREVENT FIRE OR SHOCK HAZARD, DO NOT EXPOSE THIS APPLIANCE TO RAIN OR MOISTURE. TO PREVENT THE SPREAD OF FIRE, KEEP CANDLES OR OPEN FLAMES AWAY FROM THIS PRODUCT AT TIMES.
CAUTION: TO PREVENT ELECTRIC SHOCK DO NOT USE THIS POLARIZED PLUG WITH AN EXTENSION CORD, RECEPTACLE OR OTHER OUTLET UNLESS THE BLADES CAN BE FULLY INSERTED TO PREVENT BLADE EXPOSURE.

WARNING: This equipment has been tested and found to comply with the limits for a Class B digital device, pursuant to Part 15 of the FCC Rules. These limits are designed to provide reasonable protection against harmful interference in a residential installation. This equipment generates, uses and can radiate radio frequency energy and, if not installed and used in accordance with the instructions, may cause harmful interference to radio communications.

However, there is no guarantee that interference will not occur in a particular installation. If this equipment does cause harmful interference to radio or television reception, which can be determined by turning the equipment off and on, the user is encouraged to try to correct the interference by one or more of the following measures:

- Reorient or relocate the receiving antenna.
- Increase the separation between the equipment and receiver.
- Connect the equipment into an outlet on a circuit different from that to which the receiver is connected.
- Consult the dealer or an experienced radio/TV technician for help.

CAUTION: Changes or modifications not expressly approved by the party responsible for compliance with the FCC Rules could void the user's authority to operate this equipment.

CAUTION: THIS DIGITAL VIDEO PLAYER EMPLOYS A LASER SYSTEM. TO ENSURE PROPER USE OF THIS PRODUCT, PLEASE READ THIS OWNER'S MANUAL CAREFULLY AND RETAIN FOR FUTURE REFERENCE. SHOULD THE UNIT REQUIRE MAINTENANCE, CONTACT AN AUTHORIZED SERVICE LOCATION-SEE SERVICE PROCEDURE. USE OF CONTROLS, ADJUSTMENTS OR THE PERFORMANCE OF PROCEDURES OTHER THAN THOSE SPECIFIED HEREIN MAY RESULT IN HAZARDOUS RADIATION EXPOSURE. TO PREVENT DIRECT EXPOSURE TO THE LASER BEAM, DO NOT TRY TO OPEN THE ENCLOSURE. RADIATION MAY BE PRESENT WHEN THE ENCLOSURE IS OPENED. DO NOT STARE INTO THE BEAM.
--



Location of the required Marking
The rating sheet and the safety caution are on the rear of the unit.

CERTIFICATION: COMPLIES WITH FDA RADIATION PERFORMANCE STANDARDS, 21 CFR SUBCHAPTER J.

Complies with FDA performance standards for laser products except for deviations pursuant to Laser Notice No. 50, dated June 24, 2007.

The lamp(s) within this product contain mercury. Disposal should be in compliance with local, state or federal laws.

Record the model number and serial number.

Model number _____ Serial number _____

IMPORTANT SAFETY INSTRUCTIONS

- 1) Read these instructions.
- 2) Keep these instructions.
- 3) Heed all warnings.
- 4) Follow all instructions.
- 5) Do not use this apparatus near water.
- 6) Clean only with dry cloth.
- 7) Do not block any ventilation openings. Install in accordance with the manufacturer's instructions.
- 8) Do not install near any heat sources such as radiators, heat registers, stoves, or other apparatus (including amplifiers) that produce heat.
- 9) Do not defeat the safety purpose of the polarized or grounding-type plug. A polarized plug has two blades with one wider than the other. A grounding type plug has two blades and a third grounding prong. The wide blade or the third prong are provided for your safety. If the provided plug does not fit into your outlet, consult an electrician for replacement of the obsolete outlet.
- 10) Protect the power cord from being walked on or pinched particularly at plugs, convenience receptacles, and the point where they exit from the apparatus.
- 11) Only use attachments/accessories specified by the manufacturer.
- 12) Use only with cart, stand, tripod, bracket, or table specified by the manufacturer, or sold with the apparatus. When a cart is used, use caution when moving the cart/apparatus combination to avoid injury from tip-over.
- 13) Unplug this apparatus during lightning storms or when unused for long periods of time.
- 14) Refer all servicing to qualified service personnel. Servicing is required when the apparatus has been damaged in any way, such as power-supply cord or plug is damaged, liquid has been spilled or objects have fallen into the apparatus, the apparatus has been exposed to rain or moisture, does not operate normally, or has been dropped.
- 15) Apparatus should not be exposed to dripping or splashing, and objects filled with liquids, such as vases, should not be placed on the apparatus.
- 16) An outside antenna system should not be located in the vicinity of overhead power lines or other electric light or power circuits, or where it can fall into such power lines or circuits. When installing an outside antenna system, extreme care should be taken to keep from touching such power lines or circuits, as contact with them might be fatal.
- 17) Do not overload wall outlets and extension cords, as this can result in a risk of fire or electric shock.
- 18) Do not push objects through any openings in this unit, as they may touch dangerous voltage points or short out parts that could result in fire or electric shock. Never spill or spray any type of liquid into the unit.
- 19) If an outside antenna or cable system is connected to the unit, be sure the antenna or cable system is grounded to provide some protection against voltage surges and built-up static charges. Section 810 of the National Electrical Code, ANSI/NFPA 70, provides information with respect to proper grounding of the mast and supporting structure, grounding of the lead-in wire to an antenna discharge unit, size of grounding conductors, location of antenna discharge unit, connection to grounding electrodes, and requirements for the grounding electrode.
- 20) When replacement parts are required, be sure the service technician uses replacement parts specified by the manufacturer or those that have the same characteristics as the original part. Unauthorized substitutions may result in fire, electric shock or other hazards.
- 21) Upon completion of any service or repairs to this unit, ask the service technician to perform safety checks to determine that the unit is in proper operating condition.
- 22) Keep your fingers clear of the disc slot as it is closing. It may cause injury.



EXAMPLE OF ANTENNA GROUNDING AS PER THE NATIONAL ELECTRICAL CODE

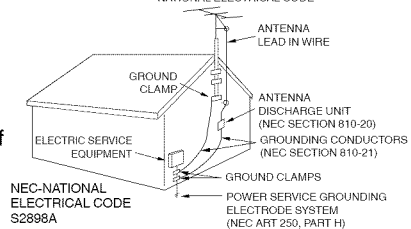

IMPORTANT SAFETY INSTRUCTIONS (continued)

- 23) When you connect the product to other equipment, turn off the power and unplug all of the equipment from the wall outlet. Failure to do so may cause an electric shock and serious personal injury. Read the owner's manual of the other equipment carefully and follow the instructions when making any connections.
- 24) Reduce the volume to the minimum level before you turn on the product. Otherwise, sudden high volume sound may cause hearing or speaker damage.
- 25) Do not allow the product to output distorted sound for an extended period of time. It may cause speaker overheating and fire.
- 26) When you use the headphones, keep the volume at a moderate level. If you use the headphones continuously with high volume sound, it may cause hearing damage.
- 27) Do not look into the opening of the disc slot or ventilation opening of the product to see the source of the laser beam. It may cause eye damage.
- 28) Do not use a cracked, deformed, or repaired disc. These discs are easily broken and may cause serious personal injury and product malfunction.
- 29) This reminder is provided to call the cable TV system installer's attention to Article 820-40 of the NEC that provides guidelines for proper grounding and, in particular, specifies that the cable ground shall be connected to the grounding system of the building, as close to the point of cable entry as practical.
- 30) The socket-outlet must be installed near the unit and easily accessible.

CONDENSATION

Moisture will form in the operating section of the player if the player is brought from cool surroundings into a warm room or if the temperature of the room rises suddenly. When this happens, player's performance will be impaired. To prevent this, let the player stand in its new surroundings for about an hour before switching it on, or make sure that the room temperature rises gradually. Condensation may also form during the summer if the player is exposed to the breeze from an air conditioner. In such cases, change the location of the player.

HOW TO HANDLE THE LCD PANEL

- Do not press hard or jolt the LCD panel. It may cause the LCD panel glass to break and injury may occur.
- If the LCD panel is broken, make absolutely sure that you do not touch the liquid in the panel. This may cause skin inflammation.
If the liquid gets in your mouth, immediately gargle and consult with your doctor. Also, if the liquid gets in your eyes or touches your skin, consult with your doctor after rinsing for at least 15 minutes or longer in clean water.

CHILD SAFETY:

It Makes A Difference How and Where You Use Your Flat Panel Display

Congratulations on your purchase! As you enjoy your new product, please keep these safety tips in mind:

THE ISSUE

The home theater entertainment experience is a growing trend and larger flat panel displays are popular purchases. However, flat panel displays are not always supported on the proper stands or installed according to the manufacturer's recommendations.

Flat panel displays that are inappropriately situated on dressers, bookcases, shelves, desks, speakers, chests or carts may fall over and cause injury.

THIS MANUFACTURER CARES!

The consumer electronics industry is committed to making home entertainment enjoyable and safe.

TUNE INTO SAFETY

One size does NOT fit all. Follow the manufacturer's recommendations for the safe installation and use of your flat panel display.

Carefully read and understand all enclosed instructions for proper use of this product.

Don't allow children to climb on or play with furniture and television sets.

Don't place flat panel displays on furniture that can easily be used as steps, such as a chest of drawers.

Remember that children can become excited while watching a program, especially on a "larger than life" flat panel display. Care should be taken to place or install the display where it cannot be pushed, pulled over, or knocked down.

Care should be taken to route all cords and cables connected to the flat panel display so that they cannot be pulled or grabbed by curious children.

WALL MOUNTING: IF YOU DECIDE TO WALL MOUNT YOUR FLAT PANEL DISPLAY, ALWAYS:

Use a mount that has been recommended by the display manufacturer and/or listed by an independent laboratory (such as UL, CSA, ETL).

Follow all instructions supplied by the display and wall mount manufacturers.

If you have any doubts about your ability to safely install your flat panel display, contact your retailer about professional installation.

Make sure that the wall where you are mounting the display is appropriate to support the weight of the unit/product and wall mount. If you are unsure, contact a professional installer.

A minimum of two people are required for installation. Flat panel displays can be heavy.

SAFETY PRECAUTIONS

The unit emits heat when in operation. Do not place any covers or blankets on the unit, this may cause overheating. Do not block ventilation holes, or set up near radiators. Do not place in direct sunshine. When placing on a shelf leave 10 cm (4 inches) free space around the entire unit.

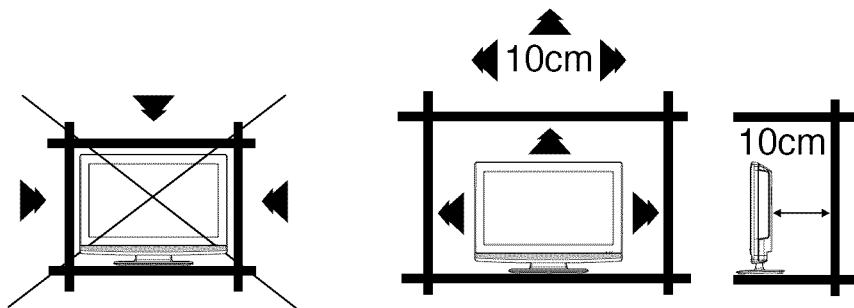

Notes when mounting the LCD TV/DVD on a wall

If the unit is to be mounted on the wall, contact the retailer where you purchased the LCD TV/DVD for advice, and have the equipment professionally installed. Incomplete or improper installation may cause injury to you, and/or damage to the LCD TV/DVD.

IMPORTANT NOTICE

Possible Adverse Effects on LCD Panel: If a fixed (non-moving) pattern remains on the LCD Panel for long periods of time, the image can become permanently engrained in the LCD Panel and cause subtle but permanent ghost images. This type of damage is NOT COVERED BY YOUR WARRANTY. Never leave your LCD Panel on for long periods of time while it is displaying the following formats or images:

- Fixed Images, such as stock tickers, video game patterns, TV station logos, and websites.
- Special Formats that do not use the entire screen. For example, viewing letterbox style (16:9) media on a normal (4:3) display (black bars at top and bottom of screen); or viewing normal style (4:3) media on a widescreen (16:9) display (black bars on left and right sides of screen).

The following symptoms are not signs of malfunction but technical limitation. Therefore we disclaim any responsibility for these symptoms.

- LCD Panels are manufactured using an extremely high level of precision technology, however sometimes parts of the screen may be missing picture elements or have luminous spots. This is not a sign of a malfunction.
- Do not install the LCD Panel near electronic equipment that is susceptible to electromagnetic waves. Some equipment placed too near this unit may cause interference.
- Effect on infrared devices – There may be interference while using infrared devices such as infrared cordless headphones.

Features

LCD color TV With DVD/CD player

Unique space saving design combines a 32" LCD color TV and a DVD/CD player.

A DVD disc has much more capacity, but is the same size as an audio CD disc. The Picture/Audio quality of a DVD exceeds other software. The picture quality is higher than Super VHS video cassettes. The audio quality is higher than an audio CD. The DVD also has special options; audio language selection, subtitle language selection, or multi-angle, etc.

The DVD PLAYER can play back both audio CDs and MP3/WMA/JPEG CDs.

Compatible with a wide range of DVD audio outputs

Digital Audio Jack (Coaxial)

- When a component with a built-in Dolby Digital decoder is connected, Dolby Digital sound can produce the effect of being in a movie theater or a concert hall.
- Surround standard is different from Dolby Digital. This format is already in use in many theaters. By connecting this unit to a DTS decoder or an AV amplifier with a built-in DTS decoder, the DTS audio of DVD discs recorded in this format can be enjoyed. However, audio will not be output from the analog audio output jacks.
- By connecting this unit to an AV amplifier with a built-in MPEG decoder, the MPEG audio of DVD discs recorded in this format can be enjoyed.
- The Linear PCM sound of a 48 kHz/24 bit through 96 kHz/24 bit exceeds audio CD sound.

Convenience Features

Direct selection of your desired scenes using Title/Chapter/Time/Track - You can play back from the desired scene.

Recalling Up to 3 Scenes - You can program up to 3 scenes in memory and recall the marked scenes.

Frame Advance - The **PAUSE/STILL** moves one frame at a time.

Slow Motion - The **SLOW** moves you back and forth through the program by 4 steps of 1/7-1/2 times.

Repeat Playback - You can repeat chapter, track, title, sides or material between two selected points.

Program Playback (Audio CD/MP3/WMA CD) - You can play back tracks in programmed sequences.

Zoom - You can zoom in the selected subject on the screen during playback.

Note: Make sure that discs are suitable for the following functions.

Multi-Language - Maximum 32 language subtitles and maximum 8 language soundtracks can be played back for movies or programs.

Multi-Angle - Pictures of Sports or a Live Concert are recorded with many cameras. When you play such a disc, you can change the angles during playback.

Parental Control - You can limit the play back of scenes or sounds of DVD discs that have a rating level encoded on the disc.

Video Aspect Ratio - You can change the aspect ratio of the screen for your monitor.

TV Features

Integrated Digital Tuner - You can view digital broadcasts without using a Digital TV Set-Top Box.

Closed Caption Decoder With Full Text Mode - Displays text captions or full screen text on the screen for hearing impaired viewers.

Picture Adjustments Using The Remote Control - The On-Screen display allows precise remote control adjustment of BRIGHTNESS, CONTRAST, COLOR, TINT and SHARPNESS.

Programmable TV Sleep Timer - Operable from the remote control, the TV can be programmed for up to 120 minutes to turn off automatically.

On-Screen 3 Language Display - You can select one of 3 languages, English, Spanish or French for on-screen programming.

V-Chip - The V-Chip function can read the rating of a TV program or movie content if the program is encoded with this information. V-chip will allow you to set a restriction level.

* **DVD** is a trademark of DVD Format/Logo Licensing Corporation.

* Manufactured under license from Dolby Laboratories. Dolby and the double-D symbol are trademarks of Dolby Laboratories.

* Manufactured under license under U.S. Patent #: 5,451,942 & other U.S. and worldwide patents issued & pending. DTS and DTS Digital Out are registered trademarks and the DTS logos and Symbol are trademarks of DTS, Inc. © 1996-2008 DTS, Inc. All Rights Reserved.

* HDMI, the HDMI logo and High-Definition Multimedia Interface are trademarks or registered trademarks of HDMI Licensing LLC.

Before using your unit

IMPORTANT SAFETY INSTRUCTIONS	3
SAFETY PRECAUTIONS	5
IMPORTANT NOTICE	5
Features	6
Contents	7
Disc	8
Location of controls	9
Remote control	11
Power source	12
Antenna connections	13
Cable TV connections	14

TV operation

Starting setup	15
Setting the on-screen language	15
Memorizing channels	15
TV operation	17
Labeling channels	18
Labeling video inputs	18
Setting the V-Chip	18
Closed Caption	20
CC advanced	21
Adjusting the picture preference	21
Picture control adjustment	21
Selecting the color temperature	22
Setting the picture size	22
Film mode	23
Picture control adjustment in the PC mode	23
DNR	23
Sound control adjustment	24
Selecting Stereo/	
Second Audio Program (SAP)	24
Selecting the audio language	24
Selecting the HDMI audio input source	25
Turning off the built-in speakers	25
Adjusting the back lighting	25
Checking the digital-signal strength	25
Setting the auto shut off	25
Resetting your settings	26

DVD operation



Preparation	26
Status display of disc	26
Playback procedure	26
Special playback	27
MP3/WMA/JPEG and Audio CD playback	27
Setting the JPEG interval	29
Program playback (CD)	29
Repeat playback (CD)	30
Random playback (CD)	30
Zooming	30
Locating desired scene	30
Repeat playback	30
Marking desired scenes	31
Changing soundtrack language	31
Subtitles	32
Changing angles	32
Title selection	32
DVD menu	32
Setting the language	32
Setting the aspect ratio of TV screen	33
Setting on screen display	33
Setting the picture mode	33
Night mode	34
Digital out	34
Parental control	34
Temporary disabling of rating level by DVD disc	35

Additional information

Language code list	36
Connections to other equipment	37
Reception disturbances	40
Problems and troubleshooting	41
Specifications	43
Limited WARRANTY	44

Disc

Playable discs

Disc type and logo mark	content
DVD Video 	Audio + Video (moving pictures)
CD-DA 	Audio
The following discs are also available. <ul style="list-style-type: none"> • DVD-R/RW discs of DVD video format. • CD-R/RW discs of MP3/WMA/JPEG. 	

CAUTION:

- Only the left types of discs can be played on this unit. DVD-ROM, CD-ROM, SVCD, CVD, VCD, etc. cannot be played.
- 8cm discs can be played directly. If an 8cm disc adapter is used it will cause errors.
- If you insert an irregular shaped disc, it may get stuck and cause a malfunction.
- The use of a ring protector or other disc accessories will cause errors.
- This unit is to be used exclusively with the NTSC color system. PAL and SECAM system discs cannot be used with this unit.
- Some CD-R/RWs and DVD-R/RWs cannot be played back depending on the recording conditions.

Region Number

Region number (Regional restriction code) is built-in to the unit and DVD video discs. Region number "1" or "ALL" of DVD video discs can be used on this unit.



Title

When two or more movies are recorded on a disc, the disc is divided into two or more sections. Each section is called a "TITLE".

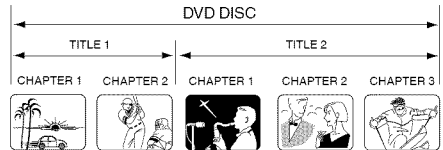

Chapter

The titles can be subdivided into many sections. Each section is called a "CHAPTER".



Track

An Audio CD can contain several items. These are assigned to the tracks.

Removing Disc from Case

Be sure to hold the edge of disc. Do not touch the surface of the disc. Pick up the disc gently from the case.

- Do not scratch the disc.
- Do not get dirt on the surface of the disc.
- Do not stick a label or adhesive tape on the disc.
- Do not drop or bend the disc.

Storing Disc

- Store the disc in the case to avoid risk of scratches, dirt or damage.
- Do not leave disc exposed to direct sunlight or in hot or humid places.

Cleaning Disc

Wipe the disc with a clean, dry cloth from center to edge.

- Do not wipe the disc in a circular motion.
- Do not use liquid or aerosol cleaners.

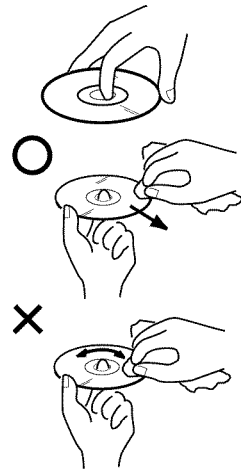

Location of controls

Front

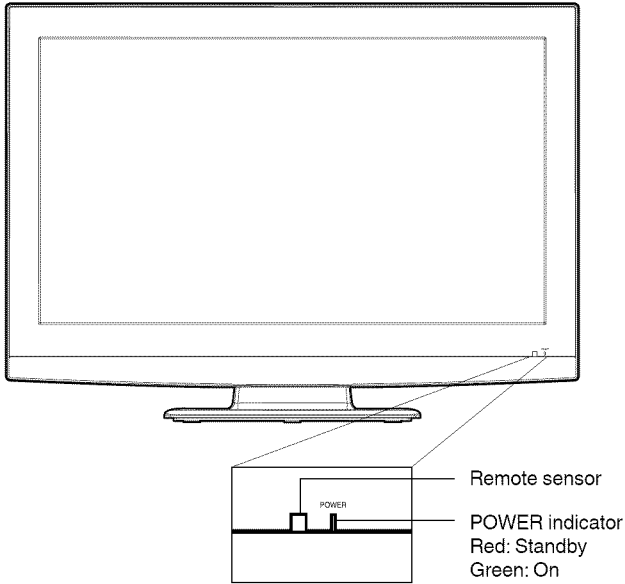

Left side

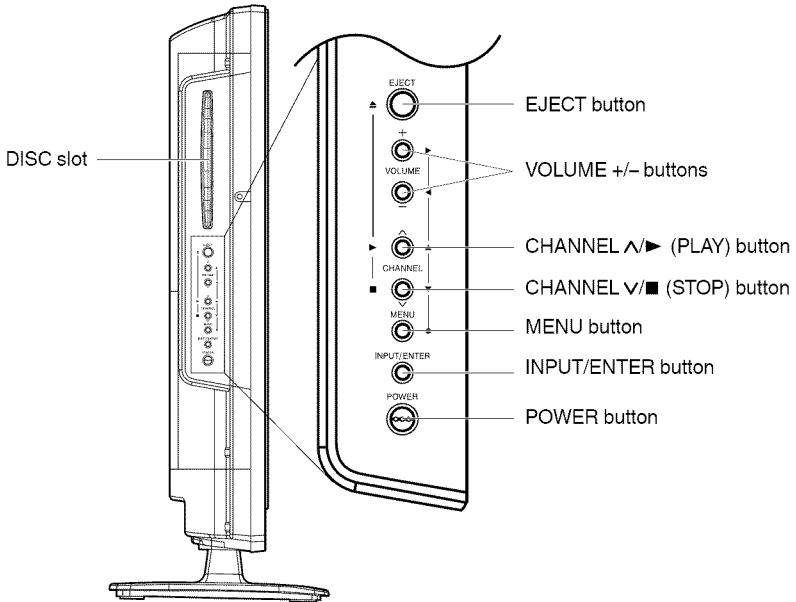

To display the menu screen.

Press **MENU** button to display the menu screen.

CHANNEL ▲/▼ buttons, **VOLUME +/-** buttons and **INPUT/ENTER** button can be used to select the desired setting during the menu screen operations.

Rear side

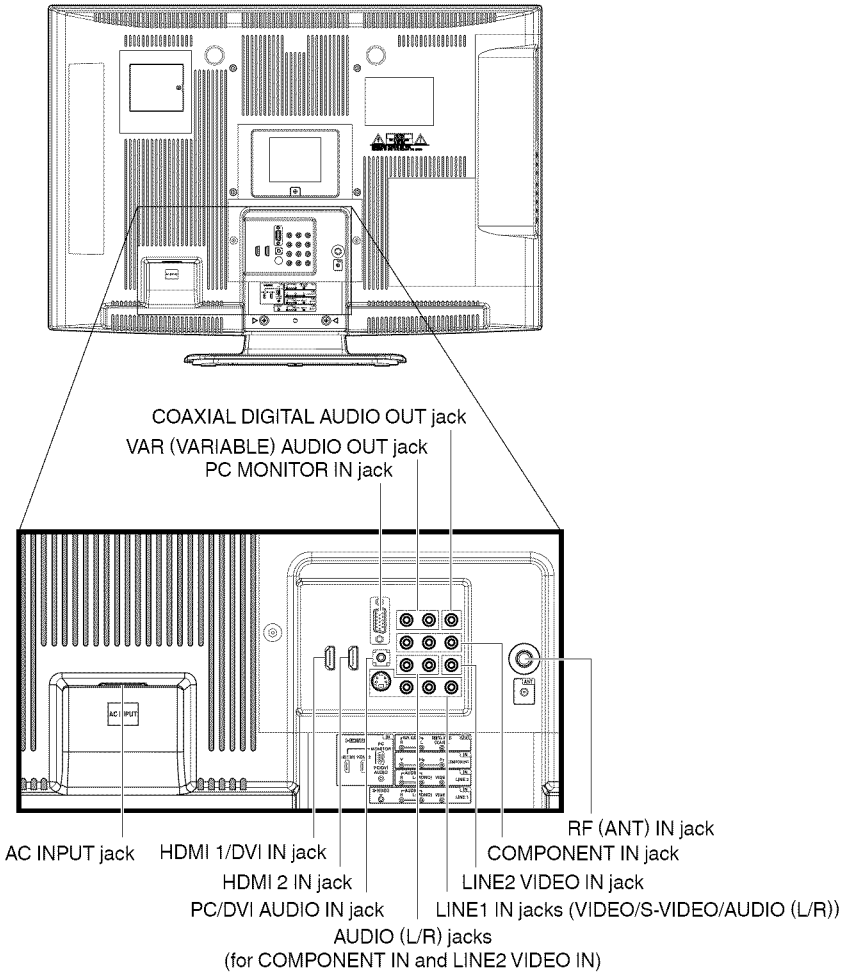

Remote control

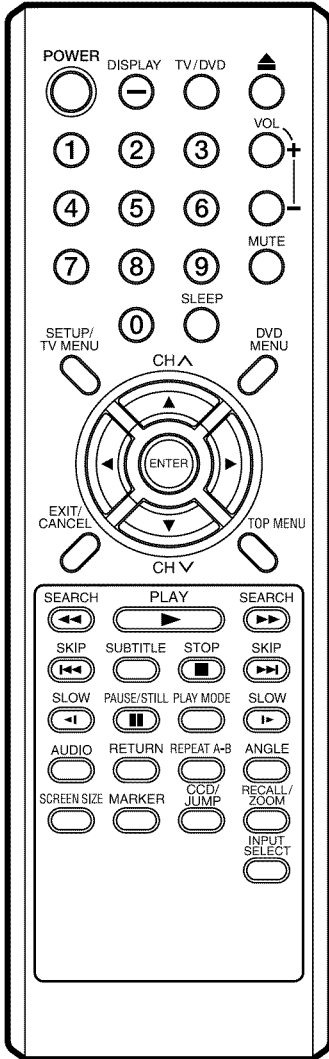

POWER	Power On/Off
DISPLAY/-	Call TV information Call DVD information Input "-" for digital channels
TV/DVD	Switch between TV/AV and DVD
▲ (EJECT)	Eject a disc
0-9	Direct channel selection of TV Input setting Enter a password
VOL +/-	Adjust volume of TV
MUTE	Switch off the sound
SLEEP	Sleep timer
SETUP/ TV MENU	TV mode - Display menu of TV DVD mode - Call up initial setup mode
DVD MENU	Display DVD menu
CH ^/v	Select channel of TV
▲▼◀▶	Cursor buttons
ENTER	Enter information in the menu
EXIT/ CANCEL	Exit from On-Screen menu Reset information in the menu
TOP MENU	Select title
SEARCH	Fast Forward/Review playback
PLAY	Playback
SKIP	Skip chapter to forward or reverse direction
SUBTITLE	Set subtitle
STOP	Stop
SLOW	Forward/Reverse- slow motion
PAUSE/STILL	Pause CD sound Still picture of DVD
PLAY MODE	Select playback mode
AUDIO	Change sound track language
RETURN	Remove DVD setup menu
REPEAT A-B	Repeat playback between A and B
ANGLE	Change playback angle
SCREEN SIZE	Display PICTURE SIZE menu
MARKER	Index
CCD/ JUMP	Closed Caption Locating desired scene
RECALL/ ZOOM	Switch between present/last channel Zoom
INPUT SELECT	Display source selection menu

ATTENTION

If you purchase a universal remote from a local retailer, please contact the remote manufacturer for the correct programming code.

Inserting Batteries

- 1 Open the battery compartment cover in the direction of the arrow.
- 2 Install two "AAA" batteries, paying attention to the polarity diagram in the battery compartment.
- 3 Replace the compartment cover.

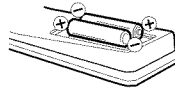

Operation

- Aim the remote control at the remote sensor and press control buttons to operate.
- Operate the remote control within a 30° angle on either side of the remote sensor, up to a distance of approximately 15 feet.

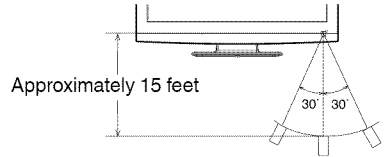

NOTE:

- Do not leave the remote control unit exposed to direct sunlight or in hot or humid places.
- The remote control unit uses infrared beams to transmit signals, so sunlight or fluorescent light on the remote sensor may shorten operating distance.
- Incorrect use of batteries may cause them to leak or burst. Read the battery warnings and use the batteries properly.
- Do not mix old and new batteries.
- Remove batteries if the remote control will not be operated for an extended period of time.

Power source

TO USE AC POWER

1. Connect the AC cord plug into this unit's AC IN jack.
2. Connect the AC cord into an AC outlet.

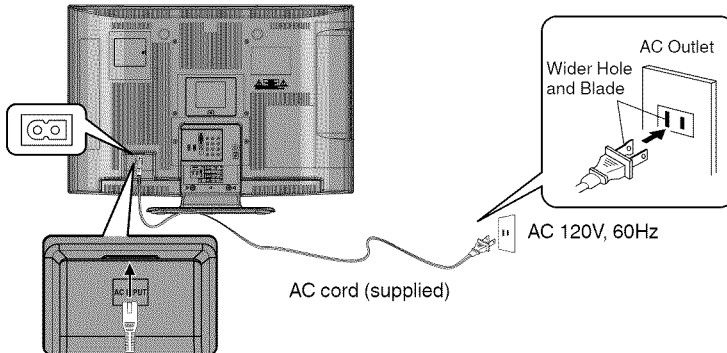

NOTE:

- Please make sure to insert the cord securely at both the LCD TV/DVD and the wall outlet.
- The AC Cord has a polarized type AC line plug. If the supplied AC cord does not match your AC outlet, contact a qualified electrician.

WARNING:

- DO NOT CONNECT THIS UNIT TO THE POWER USING ANY DEVICE OTHER THAN THE SUPPLIED AC CORD. THIS COULD CAUSE FIRE, ELECTRICAL SHOCK, OR DAMAGE.
- DO NOT USE WITH A VOLTAGE OTHER THAN THE POWER VOLTAGE SPECIFIED. THIS COULD CAUSE FIRE, ELECTRICAL SHOCK, OR DAMAGE.

CAUTION:

- WHEN THIS UNIT IS NOT USED FOR A LONG TIME, (E.G., AWAY ON A TRIP) IN THE INTEREST OF SAFETY, BE SURE TO UNPLUG IT FROM THE AC OUTLET.
- DO NOT PLUG/UNPLUG THE AC CORD WHEN YOUR HANDS ARE WET. THIS MAY CAUSE ELECTRICAL SHOCK.
- IF YOU NEED TO REPLACE THE SUPPLIED AC ADAPTER OR AC CORD, THE SPECIFIED ONE IS RECOMMENDED. CONTACT CUSTOMER SERVICE AT 1-800-289-0980.

Antenna connections

If you are using an indoor or outdoor antenna, follow the instructions below that correspond to your antenna system. If you are using a Cable TV service, see page 14 for Cable TV connections.

Combination VHF/UHF Antenna (Single 75 ohm cable or 300 ohm twin-lead wire)

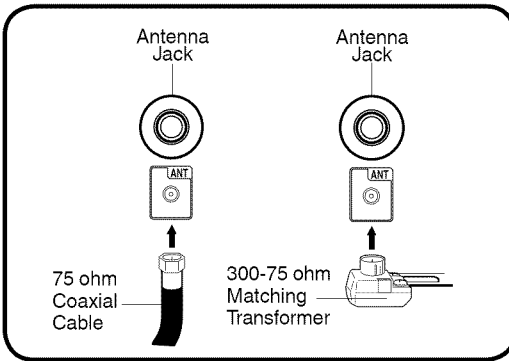

Connect the 75 ohm cable from the combination VHF/UHF antenna to the antenna jack.

If your combination VHF/UHF antenna has a 300 ohm twin-lead wire, the use of the 300-75 ohm matching transformer may be necessary.

Combination VHF/UHF Antenna (Separate VHF and UHF 300 ohm twin-lead wires)

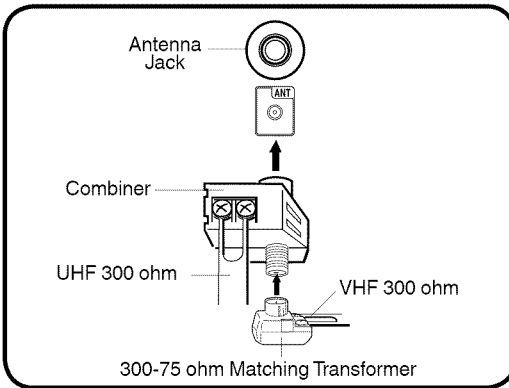

Connect the UHF 300 ohm twin-lead wire to the Combiner (not supplied). Connect the VHF 300 ohm twin-lead wire to the 300-75 ohm Matching Transformer. Attach the Transformer to the Combiner, then attach the Combiner to the Antenna Jack.

Separate VHF/UHF Antennas (75 ohm VHF cable and 300 ohm UHF twin-lead wires)

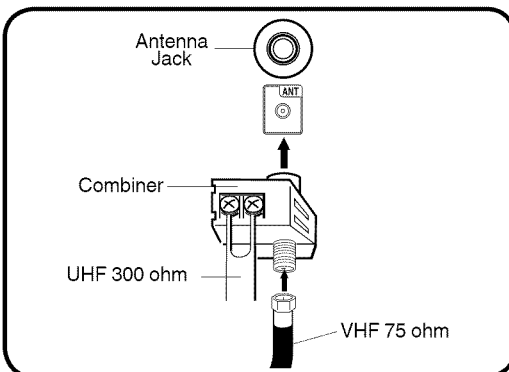

Connect the VHF 75 ohm cable and UHF 300 ohm twin-lead wire to the Combiner (not supplied). Attach the Combiner to the Antenna Jack.

Cable TV connections

This TV has an extended tuning range and can tune most cable channels without using a Cable TV Converter box. Some cable companies offer "premium pay channels" where the signal is scrambled. Descrambling these signals for normal viewing requires the use of a descrambler device which is generally provided by the Cable TV company.

For subscribers to basic Cable TV service

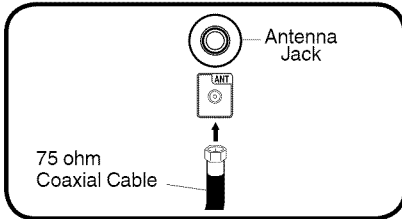

For basic Cable TV service not requiring a Converter/Descrambler box, connect the 75 ohm Coaxial Cable directly to the Antenna Jack on the back of the TV.

For subscribers to scrambled Cable TV service

If you subscribe to a Cable TV service which requires the use of a Converter/Descrambler box, connect the incoming 75 ohm Coaxial Cable to the Converter/Descrambler box. Using another 75 ohm Coaxial Cable, connect the output jack of the Converter/Descrambler box to the Antenna Jack on the TV. Follow the connections shown below. Set the TV to the output channel of the Converter/Descrambler box (usually channel 3 or 4) and use the Converter/Descrambler box to select channels.

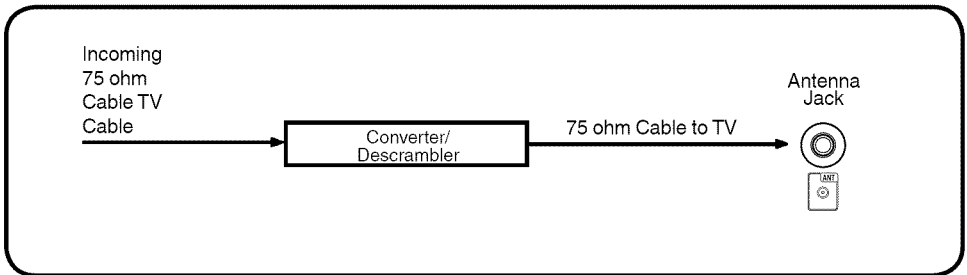

For subscribers to unscrambled Cable TV service with scrambled premium channels

If you subscribe to a Cable TV service in which basic channels are unscrambled and premium channels require the use of a Converter/Descrambler box, you may wish to use a signal Splitter and an A/B Switch box (available from the Cable TV company or an electronics supply store). Follow the connections shown below. With the switch in the "B" position, you can directly tune any unscrambled channels on your TV. With the switch in the "A" position, tune your TV to the output of the Converter/Descrambler box (usually channel 3 or 4) and use the Converter/Descrambler box to tune scrambled channels.

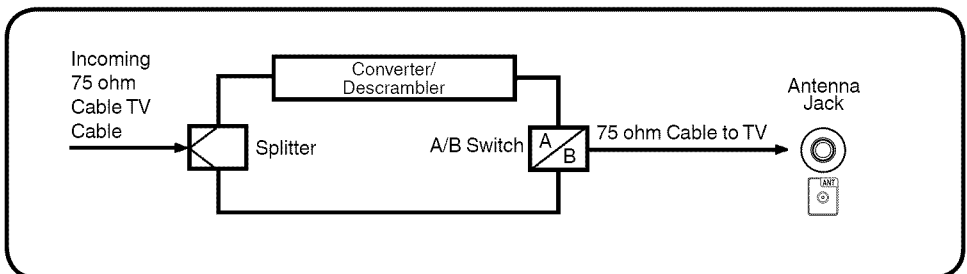

Starting setup

The Starting Setup menu appears the first time you turn on the TV, and assists you to select the menu language, specify the Air/Cable setting, and program your channels automatically.

IMPORTANT: Make sure that the antenna or cable TV system connection is made!

- 1 To turn on the TV, press **POWER** (POWER indicator on the front of the unit changes green. It may take approx. 10 seconds for a picture to appear on screen.). The starting setup function begins. Press ◀ or ▶ to select your desired language.

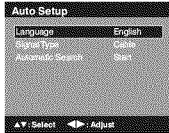

- 2 Press ▲ or ▼ to select "Signal Type", then press ◀ or ▶ to select "Cable" or "Air".
- 3 Press ▲ or ▼ to select "Automatic Search", then press ▶ or **ENTER**.
- 4 Now the "Auto Setup" starts. After the starting setup is completed, the TV channel appears on the screen.
 - Depending on the reception condition, it may take from 15 minutes to 30 minutes to complete memorizing digital cable channels. Please be patient.

NOTE:

- If you press **EXIT/CANCEL** in the process of "Auto Setup", the Starting Setup stops and changes to the normal screen.
- When you make a menu selection, your changes occur immediately. You do not have to press **EXIT/CANCEL** to see your changes.
- When you are finished programming the menus, press **EXIT/CANCEL**.

Setting the on-screen language

You can choose from three different languages (English, French and Spanish) for the on-screen displays.

Select the language you prefer first, then proceed with the other menu options.

- 1 Press **POWER**.
- 2 Press **TV/DVD** to select TV mode.
- 3 Press **SETUP/TV MENU**. The TV menu screen will appear.



- 4 Press ▲ or ▼ to select "Setup", then press ▶ or **ENTER**.

- 5 Press ▲ or ▼ to select "Language".



- 6 Press ◀ or ▶ to select the desired language: English, French (Français) or Spanish (Español).

- 7 Press **EXIT/CANCEL** to return to the normal screen.

NOTE:

- If no buttons are pressed for more than about 60 seconds, the menu screen will return to normal operation automatically.

Memorizing channels

This TV is equipped with a channel memory feature which allows channels to skip up or down to the next channel set into memory, skipping over unwanted channels. Before selecting channels, they must be programmed into the TV's memory. To use this TV with an antenna, set the Signal Type option to the Air mode. When shipped from the factory, this menu option is in the Cable mode.

Air/Cable selection

- 1 Press **SETUP/TV MENU** in the TV mode. The TV menu screen will appear.
- 2 Press ▲ or ▼ to select "Channel", then press ▶ or **ENTER**.
- 3 Press ▲ or ▼ to select "Auto Ch Memory", then press ▶ or **ENTER**.
- 4 Press ▲ or ▼ to select "Signal Type".
- 5 Press ◀ or ▶ to select "Air" or "Cable".

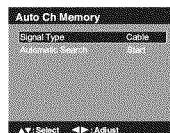
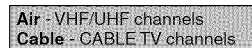

- 6 Press **EXIT/CANCEL** to return to the normal screen.

CABLE CHART

The chart below is typical of many cable system channel allocations.

Number on this TV Corresponding CABLE channel												14	15	16	17	18	19	20	21	22
J	K	L	M	N	O	P	Q	R	S	T	U	V	W	AA	BB	CC	DD			
23	24	25	26	27	28	29	30	31	32	33	34	35	36	37	38	39	40			
41	42	43	44	45	46	47	48	49	50	51	52	53	54	55	56	57	58			
EE	FF	GG	HH	II	JJ	KK	LL	MM	NN	OO	PP	QQ	RR	SS	TT	UU	VV			
59	60	61	62	63	64	65	66	67	68	69	70	71	72	73	74	75	76			
WW	XX	YY	ZZ	AAA	BBB	CCC	DDD	EEE	FFF	GGG	HHH	III	JJJ	KKK	LLL	MMM	NNN			
77	78	79	80	81	82	83	84	85	86	87	88	89	90	91	92	93	94			
RRR	SSS	TTT	UUU	VVV	WWW	XXX	YYY	ZZZ	86	87	88	89	90	91	92	93	94			
95	96	97	98	99	100	101	102	103	104	105	106	107	108	109	110	111	112			
AAA	AAA	AAA	AAA	AAA	AAA	AAA	AAA	AAA	AAA	AAA	AAA	AAA	AAA	AAA	AAA	AAA	AAA			
113	114	115	116	117	118	119	120	121	122	123	124	125	126	127	128	129	130			
131	132	133	134	135																
131	132	133	134	135																

NOTE:

- It may take a few seconds for a digital channel picture to appear on screen after being selected.

Automatic search

- Press **SETUP/TV MENU** in the TV mode. The TV menu screen will appear.
- Press **▲** or **▼** to select "Channel", then press **▶** or **ENTER**.
- Press **▲** or **▼** to select "Auto Ch Memory", then press **▶** or **ENTER**.
- Press **▲** or **▼** to select "Automatic Search", then press **▶** or **ENTER**.



- The TV will begin memorizing all the channels available in your area.
 - It may take from 15 minutes to 30 minutes to complete memorizing digital cable channels. Depending on the reception condition, a bar display may not advance for several minutes, please be patient.

NOTE:

- Memorizing channels is best accomplished during evening "PRIMETIME" hours, as more stations are broadcasting digital signals. Memorizing channels can only be accomplished while a station is broadcasting a digital signal to set that channel into memory.
- If you are unsure of the digital channels available in your area, you may visit www.antennaweb.org to receive a list based on your address or zip code. Should you require further assistance you may call our toll-free customer service line at 1-800-289-0980.
- New digital channels may be added to your area periodically, it is recommended to perform the "Automatic Search" procedure regularly.

Adding Channel (Digital Channel Only)

If you find a new channel unregistered, you can add the new channel into the channel memory.

- Tune in the new channel.
- Press **SETUP/TV MENU** in the TV mode. The TV menu screen will appear.

- Press **▲** or **▼** to select "Channel", then press **▶** or **ENTER**.

- Press **▲** or **▼** to select "Add/Delete", then press **▶** or **ENTER**.



- Press **▲** or **▼** to select "Adding Channel", then press **▶** or **ENTER**. The new channel will be added into the channel memory.
- Press **EXIT/CANCEL** to return to the normal screen.

Add/Delete channel

You can select the channel that you want to skip.

- Press **SETUP/TV MENU** in the TV mode. The TV menu screen will appear.
- Press **▲** or **▼** to select "Channel", then press **▶** or **ENTER**.
- Press **▲** or **▼** to select "Add/Delete", then press **▶** or **ENTER**.
- Press **▲** or **▼** to select "Add/Delete", then press **▶** or **ENTER**.
- Press **▲** or **▼** to select the channel that you want to skip.



- Press **◀** or **▶** to select "Add" or "Delete", whichever function you want to perform.
- Repeat steps 5 - 6 for other channels you want to add or delete.
- Press **EXIT/CANCEL** to return to the normal screen.

Clear All

All channels are deleted from the channel memory.

- Press **SETUP/TV MENU** in the TV mode. The TV menu screen will appear.
- Press **▲** or **▼** to select "Channel", then press **▶** or **ENTER**.
- Press **▲** or **▼** to select "Add/Delete", then press **▶** or **ENTER**.
- Press **▲** or **▼** to select "Clear All", then press **▶** or **ENTER**.



- Press **EXIT/CANCEL** to return to the normal screen.

TV operation

- 1 To turn on the TV, press **POWER**. (POWER indicator on the front of the unit changes green. It may take approx. 10 seconds for a picture to appear on screen.)
- 2 Adjust the volume level by pressing **VOL +** or **-**. The volume level will be indicated on the screen by blue bars. As the volume level increases, so do the number of bars. If the volume decreases, the number of blue bars also decreases.
- 3 Set the Signal Type option to the appropriate position (see "Air/Cable selection" on page 15).
- 4 Press the **Direct Channel Selection (0-9, -)** buttons to select the channel. (If you press only channel number, channel selection will be delayed for a few seconds.)

TO SELECT ANALOG CHANNELS

- 1-9: Press 1-9 as needed. Example, to select channel 2, press **2**, then press **ENTER**.
- 10-99: Press the 2 digits in order. Example, to select channel 12, press **1**, **2**, then press **ENTER**.
- 100-135: Press the 3 digits in order. Example, to select channel 120, press **1**, **2**, **0**, then press **ENTER**.

TO SELECT DIGITAL CHANNELS

Press the first 3 digits, then press the **-** button, followed by the remaining number. Example, to select channel 015-001, press **0**, **1**, **5**, **-**, **0**, **0**, **1**, then press **ENTER**.

- If a channel is selected with only audio content, "Audio only" will be displayed on the screen.
- If a channel is selected with a weak digital signal, "Digital channel signal strength is low" will be displayed on the screen. The same program may be available on either an analog channel or a digital channel. You may choose to watch either format.
- If a channel is selected to which you have not subscribed, "Digital channel is encrypted" will be displayed on the screen.

VHF/UHF/CABLE CHANNELS

Air	Cable
VHF 2-13	VHF 2-13
UHF 14-69	STD/HRC/IRC 14-36 (A) (W) 37-59 (AA) (WWW) 60-85 (AAA) (ZZZ) 86-94 (86) (94) 95-99 (A-5) (A-1) 100-135 (100) (135) 01 (4A)

NOTE:

- If a channel with no broadcast is selected, the sound will automatically be muted.
- It may take a few seconds for a digital channel picture to appear on screen after being selected.

To select the video input source

To view a signal from another device connected to your LCD TV, such as a VCR player, press **INPUT SELECT**, then press **▲/▼** or corresponding **Number buttons (0-7)**, then press **ENTER**. You can select TV, Video 1, Video 2, Component, HDMI1, HDMI2, PC or DVD depending on which input jacks you used to connect your devices.

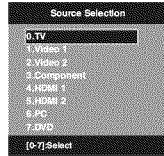

CH ▲/▼

Press and release **CH ▲/▼**. The channel automatically stops at the next channel set into memory. For proper operation, before selecting channels, they should be set into the memory. See "Memorizing channels" on pages 15 and 16.

DISPLAY

Press **DISPLAY** to display the current information on the screen.

When the TV receives a digital signal, the digital information will appear.

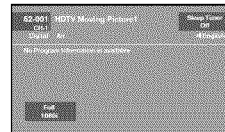

- Channel number
- Channel label (if preset)
- V-Chip rating
- Sleep timer
- Program guide
- Resolution
- Station name
- Broadcast program name
- Signal type
- Audio language
- Picture size

When the TV receives an analog signal, the analog information will appear.



- Channel number
- V-Chip rating
- Sleep timer
- Audio information (Stereo, SAP or Mono)
- Channel label (if preset)
- Signal type
- Picture size
- Resolution

Press **DISPLAY** again to clear the call display.

NOTE:

- After a few seconds, DISPLAY screen will return to normal TV-operation automatically.

RECALL

This button allows you to go back to the last channel selected by pressing **RECALL**. Press **RECALL** again to return to the last channel you were watching.

MUTE

Press **MUTE** to switch off the sound. The TV's sound will be silenced and "Mute" will appear on the screen. The sound can be switched back on by pressing this button again or the **VOL +** or **-**.

SLEEP

To set the TV to turn off after a preset amount of time, press **SLEEP** on the remote control. The clock will count up 10 minutes for each press of the **SLEEP** button (Off, 0h 10m, 0h 20m, ..., 2h 0m). After the sleep time is programmed, the display will appear briefly every ten minutes to remind you that the sleep timer is operating. To confirm the sleep timer setting, press **SLEEP** and the remaining time will be displayed for a few seconds. To cancel the sleep timer, press **SLEEP** repeatedly until the display turns to Off.

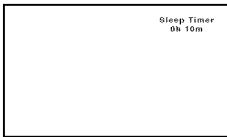

Labeling channels

Channel label appear with the channel number display each time you turn on the TV, select a channel, or press **DISPLAY**. You can choose any four characters to identify a channel.

To create channel labels

- 1 Press **SETUP/TV MENU** in the TV mode. The TV menu screen will appear.
- 2 Press **▲** or **▼** to select "Channel", then press **▶** or **ENTER**.
- 3 Press **▲** or **▼** to select "Ch Label", then press **▶** or **ENTER**. The "Ch Label" menu will appear.
- 4 Press **◀** or **▶** to select a channel you want to label, then press **▼**.



- 5 Press **◀** or **▶** repeatedly until the character you want appears in the first space.



The characters rotation as follows:

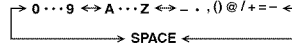

If the character which you desire appears, press **ENTER**.

Repeat this step to enter the rest of the characters.

If you would like a blank space in the label name, you must choose the empty space from the list of characters.

- 6 When you finish inputting the label name, press **EXIT/CANCEL** to return to the normal screen.
- 7 Repeat steps 4-5 for other channel. You can assign a label to each channel.

To clear a Ch Label

After step 4 above, press **▲** or **▼** to select "Label Clear", then press **▶** or **ENTER**.

NOTE:

- The channel labels will be reset after "Automatic Search" on page 16.

Labeling video inputs

The Video Label feature allows you to label each input source for your TV.

- 1 Press **SETUP/TV MENU** in the TV mode. The TV menu screen will appear.
- 2 Press **▲** or **▼** to select "Setup", then press **▶** or **ENTER**.
- 3 Press **▲** or **▼** to select "Video Label", then press **▶** or **ENTER**.
- 4 Press **▲** or **▼** to select an input which you want to label.
- 5 Press **◀** or **▶** to select the desired label for that input source.



- : Uses the default label name
- VCR** : Video cassette recorder
- DVD** : DVD video
- DTV** : Digital TV set-top box
- SAT** : Satellite box
- CBL** : Cable box
- HD** : HDMI device (only for HDMI inputs)

- 6 Press **EXIT/CANCEL** to return to the normal screen.

Setting the V-Chip

An age limitation can be set to restrict children from viewing or hearing violent scenes or pictures that you may choose to exclude. The restriction applies to "TV Rating" and "Movie

Rating” if this data is transmitted. You may set this restriction separately. To use the V-Chip function, you must register a password.

To register a password

- 1 Press **SETUP/TV MENU** in the TV mode. The TV menu screen will appear.
- 2 Press **▲** or **▼** to select “Lock”, then press **▶** or **ENTER**.
- 3 Select and enter your password (4 digits) using **Number buttons (0-9)**, then press **ENTER**.

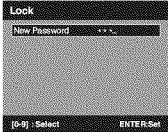

“*” appears instead of the number.

- 4 Enter the same password again to confirm, then press **ENTER**.
The password is now registered.

NOTE:

- If you forget the password, contact Customer Service at 1-800-289-0980 for assistance. Your original remote control will be required.
- To avoid forgetting the password, write it down and keep in a safe place.

To set the V-Chip

- 1 Press **SETUP/TV MENU** in the TV mode. The TV menu screen will appear.
- 2 Press **▲** or **▼** to select “Lock” menu, then press **▶** or **ENTER**.
- 3 Use **Number buttons (0-9)** to enter your password, then press **ENTER**. Then Lock menu will appear.
- 4 Press **▲** or **▼** to select “V-Chip”, then press **◀** or **▶** to select “On”.
- 5 Press **▲** or **▼** to select “V-Chip Set”, then press **▶** or **ENTER**.
The V-Chip Set Menu appears.
- 6 Press **▲** or **▼** to select which rating will be used, then press **▶** or **ENTER**. Each rating below will appear.

TV Rating

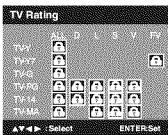

You can set the rating using age level and genre.

- Age:**
TV-Y : All children
TV-Y7 : 7 years old and above
TV-G : General audience
TV-PG : Parental guidance
TV-14 : 14 years old and above
TV-MA : 17 years old and above

- Genre:**
ALL : All
D : Dialogue
L : Language
S : Sex
V : Violence
FV : Fantasy Violence

Movie Rating

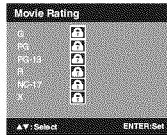

- G** : All ages
PG : Parental guidance
PG-13 : Parental guidance less than 13 years old
R : Under 17 years old parental guidance suggested
NC-17 : 17 years old and above
X : Adult only

- 7 Press **▲/▼/◀/▶** to select the desired rating, then press **ENTER**.
- 8 Press **EXIT/CANCEL** to return to the normal screen. V-Chip function is activated now.

To use the TV after the TV is protected.

When a program is received that is blocked by the V-Chip, press **MUTE**, then enter your password. The protection will be temporarily overridden. If the TV is turned off or the channel is changed, the V-Chip restriction will be reactivated.

NOTE:

- The V-Chip function is activated only on programs and input sources that include a rating signal.

To change the password

- 1 Press **SETUP/TV MENU** in the TV mode. The TV menu screen will appear.
- 2 Press **▲** or **▼** to select “Lock”, then press **▶** or **ENTER**.
- 3 Use **Number buttons (0-9)** to enter your password, then press **ENTER**. The Lock menu will appear.
- 4 Press **▲** or **▼** to select “Change Password”, then press **▶** or **ENTER**.
The Change Password screen will appear.
- 5 Enter a new password using **Number buttons (0-9)**, then press **ENTER**.
- 6 Enter the same password again to confirm, then press **ENTER**.
The password is now registered.

Downloading the additional V-Chip rating system

As a supplement to the standard V-Chip rating system, your television will be able to download an additional rating system, if such a system becomes available in the future.

To download the additional V-Chip rating system (when available)

- 1 Press **SETUP/TV MENU** while on a digital channel.
- 2 Press **▲** or **▼** to select "Lock", then press **▶** or **ENTER**.
- 3 Use **Number buttons (0-9)** to enter your password, then press **ENTER**. The Lock menu will appear.
- 4 Press **▲** or **▼** to select "V-Chip Set (DTV)", then press **▶** or **ENTER**.
- 5 If the TV is not storing the additional rating system, the TV will begin downloading it, which may take some time to be completed.
- 6 Set your preferred content rating limits for the additional rating system.
- 7 You also need "Update" procedure to update rating information.

NOTE:

- You can only download the additional V-Chip rating system when your TV is receiving a digital signal.
- When you download the additional rating system, it may take some time for the download to occur.
- The V-Chip rating information and system are not determined or controlled by the TV.
- The standard V-Chip rating system is available whether your TV is receiving a digital signal or not, and will block both analog and digital programs. To set the restriction level using the standard V-Chip rating system, select V-Chip Set in step 4.
- The downloadable V-Chip rating system is an evolving technology, and availability, content, and format may vary.
- You cannot select this feature if the TV is not receiving a digital signal for the current station.

To clear the all V-Chip settings

- 1 Press **SETUP/TV MENU** in the TV mode. The TV menu screen will appear.
- 2 Press **▲** or **▼** to select "Lock", then press **▶** or **ENTER**.
- 3 Use **Number buttons (0-9)** to enter your password, then press **ENTER**. The Lock menu will appear.
- 4 Press **▲** or **▼** to select "V-Chip Clear", then press **▶** or **ENTER**. The Password screen will appear.
- 5 Use **Number buttons (0-9)** to enter your password, then press **ENTER**. All of your settings return to the factory settings.

Closed Caption

WHAT IS CLOSED CAPTIONING?

This television has the capability to decode and display Closed Captioned television programs. Closed Captioning will display text on the screen for hearing impaired viewers or it will translate and display text in another language.

Captions: This Closed Caption Mode will display text on the screen in English or another language. Generally, Closed Captions in English are transmitted on C1 and Closed Captions in other languages are transmitted on C2.

Text: The Text Closed Caption Mode will usually fill 1/2 of the screen with a programming schedule or other information.

- 1 Press **SETUP/TV MENU** in the TV mode. The TV menu screen will appear.
- 2 Press **▲** or **▼** to select "Setup", then press **▶** or **ENTER**.
- 3 Press **▲** or **▼** to select "Closed Caption", then press **▶** or **ENTER**. The Closed Caption menu will appear.
- 4 Press **◀** or **▶** to set "CC Setting" to "On".
On: Captions will be displayed on the screen.
Off: Captions will not be displayed on the screen.
- 5 Press **▲** or **▼** to select "Analog Caption" or "Digital Caption".
When you select "Analog Caption", you can choose C1, C2, C3, C4, T1, T2, T3 and T4.
When you select "Digital Caption", you can choose from CS1, CS2, CS3, CS4, CS5 and CS6.
- 6 Press **◀** or **▶** to select the desired Closed Caption mode for both Digital and Analog Caption.
- 7 Press **▲** or **▼** to select "CC Priority", then press **◀** or **▶** to select "Digital CC" or "Analog CC".

NOTE:

- Depending on the broadcast signal, some Analog Captions will function with a Digital broadcast signal. This step Prevents two types of captions from overlapping.

- 8 Press **EXIT/CANCEL** to return to the normal screen.

NOTE:

- If the program or video you selected is not closed-captioned, no captions will display on-screen.
- If text is not available in your viewing area, a black rectangle may appear on-screen. If this happens, set the CC Setting to "Off".
- When selecting Closed Captions, the captioning will be delayed approx. 10 seconds.
- If no caption signal is received, no captions will appear, but the television will remain in the Caption Mode.
- Misspellings or unusual characters may occasionally appear during Closed Captioning.

This is normal with Closed Captioning, especially with live programs. This is because during live programs, captions are also entered live. These transmissions do not allow time for editing.

- When Captions are being displayed, on-screen displays, such as volume and mute may be seen but may interfere with Closed Captions.
- Some cable systems and copy protection systems may interfere with the Closed Captioned signal.
- If using an indoor antenna or if TV reception is very poor, the Closed Caption Decoder may not appear or may appear with strange characters or misspelled words. In this case, adjust the antenna for better reception or use an outdoor antenna.

CC advanced

When you have selected Custom as the display method, you can adjust the various setting listed below as follows:

This feature is designed to customize Digital Captions only.

- 1 Press **SETUP/TV MENU** in the digital channel. The TV menu screen will appear.
- 2 Press **▲** or **▼** to select "Setup", then press **▶** or **ENTER**.
- 3 Press **▲** or **▼** to select "Closed Caption", then press **▶** or **ENTER**. The Closed Caption menu will appear.
- 4 Press **▲** or **▼** to select "Digital CC Preset", then press **◀** or **▶** to select "Custom".
- 5 Press **▲** or **▼** to select "CC Advanced", then press **▶** or **ENTER**. The CC Advanced menu will appear.
- 6 Press **▲** or **▼** to select the desired item, then press **◀** or **▶** to change the setting.

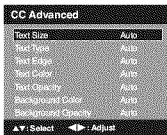

You can select from among the following items and parameters.

- Text Size:** Auto, Small, Standard, Large
- Text Type:** Auto, Style1, Style2, Style3, Style4, Style5, Style6, Style7
- Text Edge:** Auto, None, Raised, Depressed, Uniform, Left Shadow, Right Shadow
- Text Color:** Auto, Black, White, Red, Green, Blue, Yellow, Magenta, Cyan
- Text Opacity:** Auto, Solid, Transparent, Translucent, Flashing
- Background Color:** Auto, Black, White, Red, Green, Blue, Yellow, Magenta, Cyan
- Background Opacity:** Auto, Solid, Transparent, Translucent, Flashing

- 7 Press **EXIT/CANCEL** to return to the normal screen.

NOTE:

- You cannot set both "Text Color" and "Background Color" as a same color.
- You cannot set both "Text Opacity" and "Background Opacity" to "Transparent".

Adjusting the picture preference

You can select four picture modes—Sports, Standard, Movie and Memory—as described in the following table:

- 1 Press **SETUP/TV MENU** in the TV mode. The TV menu screen will appear.
- 2 Press **▲** or **▼** to select "Picture", then press **▶** or **ENTER**.
- 3 Press **▲** or **▼** to select "Picture Preference".
- 4 Press **◀** or **▶** to select a mode you want to adjust.

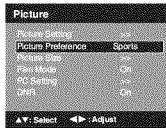

Mode	Picture Quality
Sports	Bright and dynamic picture (factory-set)
Standard	Standard picture quality (factory-set)
Movie	Movie-like picture setting (factory-set)
Memory	Your personal preferences (set by you; see "Picture control adjustment" below).

- 5 After your desired setting, press **EXIT/CANCEL** to return to the normal screen.

Picture control adjustment

- 1 Press **SETUP/TV MENU** in the TV mode. The TV menu screen will appear.
- 2 Press **▲** or **▼** to select "Picture", then press **▶** or **ENTER**.
- 3 Press **▲** or **▼** to select "Picture Setting", then press **▶** or **ENTER**. The Picture Setting menu will appear.
- 4 Press **▲** or **▼** to select the item you want to adjust. Press **◀** or **▶** to adjust the setting.

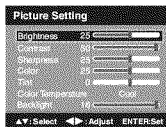



- 5 After adjusting, press **ENTER** to return to the Picture Setting menu. Then continue to adjust the other items.

	◀	▶
Brightness	decrease brightness	increase brightness
Contrast	decrease contrast	increase contrast
Sharpness	makes picture softer	makes picture clearer
Color	be pale color	be brilliant color
Tint	be reddish color	be greenish color

- 6 After your desired setting, press **EXIT/CANCEL** to return to the normal screen.

NOTE:

- The Contrast default setting is set to maximum at the factory.

Selecting the color temperature

- Press **SETUP/TV MENU** in the TV mode. The TV menu screen will appear.
- Press **▲** or **▼** to select "Picture", then press **▶** or **ENTER**.
- Press **▲** or **▼** to select "Picture Setting", then press **▶** or **ENTER**. The Picture Setting menu will appear.
- Press **▲** or **▼** to select "Color Temperature", then press **◀** or **▶** to change the setting.

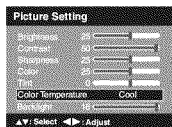

Setting	Picture Quality
Cool	Bluish
Standard	Neutral
Warm	Reddish

- 5 Press **EXIT/CANCEL** to return to the normal screen.

Setting the picture size

You can view 480i and 480p format programs in a variety of picture sizes— Natural, Cinema Wide1, Cinema Wide2, Cinema Wide 3, Full and Native.

Selecting the picture size

- Press **SETUP/TV MENU** in the TV mode. The TV menu screen will appear.
- Press **▲** or **▼** to select "Picture", then press **▶** or **ENTER**.
- Press **▲** or **▼** to select "Picture Size", then press **▶** or **ENTER** to display Picture Size menu. Press **▲/▼** or corresponding **Number buttons (0-4)** to select the desired picture size, as described below.

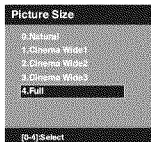

NOTE:

- Selectable picture sizes may vary depending on the input source or broadcast signal.
- Picture Size menu also can be displayed by pressing **SCREEN SIZE** on the remote control.

- Press **EXIT/CANCEL** to return to the normal screen.

Natural

In some cases, this image will display the size of standard 4:3 with a black side bar.

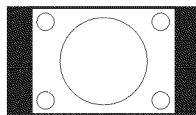

Cinema Wide1 (for 4:3 format programs)

To fill the screen, the right and left edges are extended, however; the center of the picture remains near its former ratio. The top and bottom edges of the picture may be hidden.

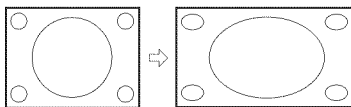

Cinema Wide2 (for letter box programs with subtitles)

To fill the width of the screen, it is extended horizontally. However; it is only slightly extended at the top and the bottom.

The top and bottom edges of the picture may be hidden.

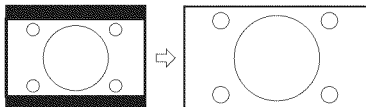

Cinema Wide3 (for letter box programs with subtitles)

To fill the width of the screen, it is extended horizontally. However; it is only slightly extended at the top and the bottom.

The top and bottom edges of the picture may be hidden.

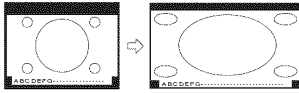

Full (for 16:9 source programs)

Full will display the picture at the maximum size.

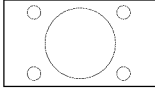

Native (for PC mode only)

Detects the resolution of the signal of the image and it will be shown on the screen with same amount of pixels.

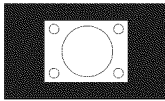

NOTE:

- Some High Definition and/or Digital broadcasts may not allow you to change the picture size.
- In HDMI or COMPONENT mode with a scanning rate of 720p, 1080i or 1080p (only HDMI), only the Cinema Wide2 and Full picture size feature is available.
- In PC Mode, only the Natural, Full and Native picture size features are available. In PC Mode (WXGA), only the Full and Native picture size features are available.

Film mode

A smoother motion may be obtained by setting the Film Mode to "On" when you view a DVD.

- 1 Press **SETUP/TV MENU** in the TV mode. The TV menu screen will appear.
- 2 Press **▲** or **▼** to select "Picture", then press **▶** or **ENTER**.
- 3 Press **▲** or **▼** to select "Film Mode". Press **◀** or **▶** to select "On" or "Off".

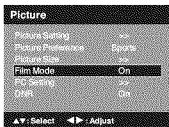

- 4 Press **EXIT/CANCEL** to return to the normal screen.

Picture control adjustment in the PC mode

You can adjust to optimize the performance of the TV in the PC mode.

- 1 Press **INPUT SELECT**, then press **▲/▼** or **Number button (6)** to select the PC mode.

- 2 Press **SETUP/TV MENU**. The TV menu screen will appear.
- 3 Press **▲** or **▼** to select "Picture", then press **▶** or **ENTER**.
- 4 Press **▲** or **▼** to select "PC Setting", then press **▶** or **ENTER**. The PC Setting menu will appear.

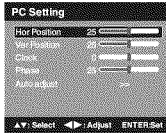

- 5 Press **▲** or **▼** to select the desired item you want to adjust.
- 6 Press **◀** or **▶** to adjust the setting.
 - Hor Position:** To adjust the horizontal position of the image on the PC mode.
 - Ver Position:** To adjust the vertical position of the image on the PC mode.
 - Clock:** To minimize any vertical bars or stripes visible on the screen background.
 - Phase:** This must be adjusted after the frequency of the PC mode has been set to 60Hz to optimize picture quality (page 39).
 - Auto Adjust:** To adjust the all PC settings automatically

- 7 After adjusting, press **ENTER** to return to the PC Setting menu. Then continue to adjust the other items.

- 8 Press **EXIT/CANCEL** to return to the normal screen.

NOTE:

- Auto Adjust feature is available only for 16:9 or 4:3 format.
- If no buttons are pressed for more than approx. 60 seconds, the Menu-screen will return to normal Monitor-screen automatically.
- The PC settings are not effective for other input modes.

DNR

DNR (Digital Noise Reduction) can reduce the roughness of the picture.

- 1 Press **SETUP/TV MENU** in the TV mode. The TV menu screen will appear.
- 2 Press **▲** or **▼** to select "Picture", then press **▶** or **ENTER**.
- 3 Press **▲** or **▼** to select "DNR". Press **◀** or **▶** to select "On" or "Off".

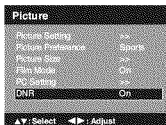

- 4 Press **EXIT/CANCEL** to return to the normal screen.

Sound control adjustment

- 1 Press **SETUP/TV MENU** in the TV mode. The TV menu screen will appear.
- 2 Press **▲** or **▼** to select "Audio", then press **▶** or **ENTER**.
- 3 Press **▲** or **▼** to select the item you want to adjust.

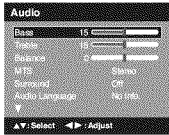

- Bass:** Press **◀** or **▶** to adjust the bass sound.
- Treble:** Press **◀** or **▶** to adjust the treble sound.
- Balance:** Press **◀** or **▶** to obtain an equal sound level from both speakers.
- Surround:**
Press **◀** or **▶** to select "On" or "Off".
On: The dynamic presence and sound created offers a thoroughly enjoyable listening experience.
Off: Normal sound.

- 4 After you desired setting, press **EXIT/CANCEL** to return to the normal screen.

Selecting Stereo/Second Audio Program (SAP)

The multi-channel TV sound (MTS) feature provides high-fidelity stereo sound. MTS also can transmit a second audio program (SAP) containing a second language or other audio information.

When the TV receives a stereo or SAP broadcast, the word "Stereo" or "SAP" displays on-screen every time you press **DISPLAY**.

- 1 Press **SETUP/TV MENU** in the TV mode. The TV menu screen will appear.
- 2 Press **▲** or **▼** to select "Audio", then press **▶** or **ENTER**.
- 3 Press **▲** or **▼** to select "MTS", then press **◀** or **▶** to select "Stereo".



- 4 Press **EXIT/CANCEL** to return to the normal screen.

NOTE:

- Generally you can leave your TV in stereo mode because the TV automatically outputs the type of sound being broadcast (stereo or mono).
- If the stereo sound is noisy, select "Mono" to reduce the noise.

To listen to a second audio program (SAP)

Press **◀** or **▶** to select "SAP" in step 3 above. The TV speakers will output the second audio program instead of normal audio.

Selecting the audio language

When two or more audio languages are included in a digital signal, you can select one of the audio languages. (This function is available only for digital broadcast.)

- 1 Press **SETUP/TV MENU** in the digital channel. The TV menu screen will appear.
- 2 Press **▲** or **▼** to select "Audio", then press **▶** or **ENTER**.
- 3 Press **▲** or **▼** to select "Audio Language", then press **▶** or **ENTER** to display the Audio Language menu.
- 4 Press **▲/▼** or **Number buttons (0-6)** to select your desired language.

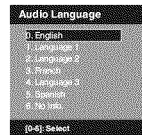

- 5 Press **EXIT/CANCEL** to return to the normal screen.

Selecting the HDMI audio input source

When you use PC/DVI AUDIO IN jack with HDMI or DVI device, you must select HDMI audio input source from "HDMI" or "DVI".

- 1 Press **SETUP/TV MENU** in the TV mode. The TV menu screen will appear.
- 2 Press **▲** or **▼** to select "Audio", then press **▶** or **ENTER**.
- 3 Press **▲** or **▼** to select "HDMI 1 Audio". Press **◀** or **▶** to select "HDMI" or "DVI".



HDMI: When you connect the HDMI device to the TV, select this setting.

DVI: When you connect the DVI device to the TV with analog audio cords, select this setting.

- 4 Press **EXIT/CANCEL** to return to the normal screen.

Turning off the built-in speakers

Use this feature to turn the TV speakers off when you connect an audio system (see pages 39).

- 1 Press **SETUP/TV MENU**. The menu screen will appear.
- 2 Press **▲** or **▼** to select "Audio", then press **▶** or **ENTER**.
- 3 Press **▲** or **▼** to select "Speakers". Press **◀** or **▶** to select "Off".

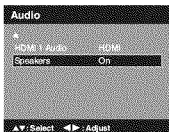

- 4 Press **EXIT/CANCEL** to return to the normal screen.

NOTE:

- If "Off" is selected, "Speakers : Off" will be displayed on the screen when the volume is changed.

To turn on the built-in speakers:
Select "On" in step 3 above.

Adjusting the back lighting

The Backlight feature adjusts the screen brightness for improved picture clarity.

- 1 Press **SETUP/TV MENU** in the TV mode. The TV menu screen will appear.
- 2 Press **▲** or **▼** to select "Picture", then press **▶** or **ENTER**.

- 3 Press **▲** or **▼** to select "Picture Setting", then press **▶** or **ENTER**. The Picture Setting menu will appear.
- 4 Press **▲** or **▼** to select "Backlight".

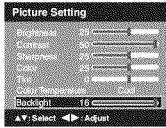

- 5 Press **◀** or **▶** to adjust the setting.
- 6 Press **EXIT/CANCEL** to return to the normal screen.

Checking the digital-signal strength

This TV will allow you to view the digital signal meter for digital channels.

- 1 Press **SETUP/TV MENU** in the TV mode. The TV menu screen will appear.
- 2 Press **▲** or **▼** to select "Channel", then press **▶** or **ENTER**.
- 3 Press **▲** or **▼** to select "DTV Signal".
- 4 Press **ENTER** to check the Digital-signal strength.

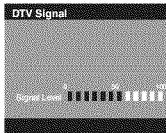

- 5 Press **EXIT/CANCEL** to return to the normal screen.

NOTE:

- Signal meter feature is not available for analog channels.
- After 240 seconds, Signal Meter screen will return to normal TV-operation automatically.

Setting the auto shut off

If the Auto Shut Off feature is On, a station being viewed stops broadcasting and the TV is not operated, the TV will automatically shut itself off after 15 minutes.

- 1 Press **SETUP/TV MENU** in the TV mode. The TV menu screen will appear.
- 2 Press **▲** or **▼** to select "Setup", then press **▶** or **ENTER**.
- 3 Press **▲** or **▼** to select "Auto Shut Off". Press **◀** or **▶** to select "On" or "Off".



- 4 Press **EXIT/CANCEL** to return to the normal screen.

Resetting your settings

The **Reset** function returns your settings to the factory settings.

- 1 Press **SETUP/TV MENU** in the TV mode. The TV menu screen will appear.
- 2 Press **▲** or **▼** to select "Setup", then press **▶** or **ENTER**.
- 3 Press **▲** or **▼** to select "Reset".



- 4 Press **▶** or **ENTER** to return your settings to the factory settings.
- 5 "Reset" will appear on the screen approx. 3 seconds, then it returns to the normal screen.

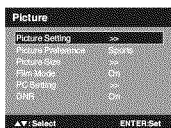

NOTE:

- "Picture Size" in Picture menu cannot be reset by this function.
- "MTS", "Audio Language" and "HDMI 1 Audio" in Audio menu cannot be reset by this function.

Preparation

The following pages describe the setup/operation in DVD mode.

Preparation

Before DVD/CD operation, please make the following preparations.

- 1 Insert the AC cord plug into a standard 120V 60Hz polarized AC outlet.
 - If the AC cord plug is plugged in for the first time, wait for about 5 seconds before pressing **POWER**.

NOTE:

- When connecting to other equipment, unplug the unit from the AC outlet.
- 2 Press **POWER** on the unit or on the remote control to turn on the unit. The **POWER** indicator will change to green.
 - Each time you turn the unit ON, the TV/DVD starts from the TV mode.
 - When using an amplifier, switch on the amplifier.
 - 3 Press **TV/DVD** to select DVD mode. The DVD startup screen will appear on the screen.



NOTE:

- If the unit does not operate properly: Static electricity, etc., may affect the player's operation. Disconnect the AC power cord once, then connect it again.

Status display of disc

Press **DISPLAY**. The status display of the disc will appear on the screen.

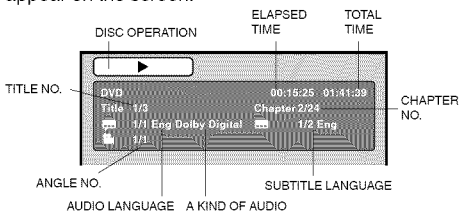

To make the status display screen disappear, press **DISPLAY** again.

Playback procedure

- 1 Press **TV/DVD** to select DVD mode.
- 2 Place the disc in the disc slot with the label side facing forward. (If the disc has a label.) Hold the disc without touching either of its surfaces, align it with the guides, and place it in position.

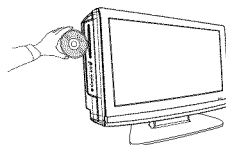

3 On the screen, “▲” changes to “Reading” and then playback will commence.

- A menu screen may appear on the TV screen, if the disc has a menu feature. In this case, press ▲, ▼, ◀, ▶ or ENTER to operate a menu feature.



4 Press STOP to end playback.

- The unit memorizes the stopped point, depending on the disc. “■” appears on the screen. Press PLAY to resume playback (from the scene point).
- If you press STOP again (“■” appears on the screen) or unload the disc, the unit will clear the stopped point.

5 Press ▲ (EJECT).

Remove the disc and then press POWER. The unit turns off.

When you eject the disc, you may hear mechanism noise, but it is not malfunction.

NOTE:

- If a non-compatible disc is loaded, “Incorrect Disc”, “Region Code Error” or “Parental Error” will appear on the TV screen according to the type of loaded disc. If these appear, check your disc again (see pages 8 and 34,35).
- Some discs may take a minute or so to start playback.
- If an 8 cm disc is placed into the disc slot and picture playback or menu display does not begin automatically, press PLAY.
- A “Prohibition” symbol “X” may appear at the upper right of the screen. This symbol means either the feature you tried is not available on the disc, or the unit cannot access the feature at this time. This does not indicate a problem with the unit.
- If you place a single-faced disc label backwards (i.e. the wrong way) “Reading” will appear in the display and then “Incorrect Disc” will be displayed.
- Some playback operations of DVDs may be intentionally fixed by software producers. Since this unit plays DVDs according to the disc content recorded, some playback features may not be available. Also refer to the instructions supplied with the DVDs.

Special playback

Fast Forward Playback

Press SEARCH ►► during normal playback.

Each press of SEARCH ►► will increase the speed of the search ►► (x 2), ►►► (x 4), ►►►► (x 8), ►►►►► (x 15).

(CD: ►► (x 2), ►►► (x 4), ►►►► (x 8), ►►►►► (x 20))

- To resume normal playback, press PLAY.

Review Playback

Press SEARCH ◀◀ during normal playback.

Each press of SEARCH ◀◀ will increase the speed of the search ◀◀ (x 2), ◀◀◀ (x 4), ◀◀◀◀ (x 8), ◀◀◀◀◀ (x 15).

(CD: ◀◀ (x 2), ◀◀◀ (x 4), ◀◀◀◀ (x 8), ◀◀◀◀◀ (x 20))

- To resume normal playback, press PLAY.

Still Playback

Press PAUSE/STILL during normal playback to pause playback.

- To resume normal playback, press PLAY.

Frame Advance

Press PAUSE/STILL during still playback.

One frame is advanced each time you press PAUSE/STILL.

- To resume normal playback, press PLAY.

Slow-motion Playback

Press SLOW ◀I Reverse or SLOW I▶ Forward during normal playback or still playback.

Each press of SLOW will change the speed of the slow x1/2, x1/4, x1/6, x1/7.

- To resume normal playback, press PLAY.
- To resume the still playback, press PAUSE/STILL.

Locating a chapter or track

Press SKIP ►►► Forward or SKIP ◀◀◀ Reverse during playback to locate a chapter that you want to watch.

Each time you press the button, a chapter or track is skipped.

NOTE:

- The unit is capable of holding a still video image or On screen display image on your television screen indefinitely. If you leave the still video image or On screen display image displayed on your TV for an extended period of time, you risk permanent damage to your television screen.
- There may be a slight delay between when you press the button and the function activating.

MP3/WMA/JPEG and Audio CD playback

This player can play back MP3/WMA/JPEG-data which has been recorded on CD-R or CD-RW. To produce MP3/WMA/JPEG-data, you need a Windows-PC with CD-ROM drive and MP3/WMA/JPEG-encoding software (not supplied). The Apple-HFS-System cannot be played.

MP3/WMA/JPEG CD information

Limitations on MP3/WMA/JPEG CD playback

- MP3/WMA/JPEG CD is the disc that is standardized by ISO9660, its file name must include 3-digit extension letters, “mp3”, “wma”, “jpg”.
- The directory and file names of MP3/WMA/JPEG CD must correspond to ISO standardized files.
- This unit can read 2000 files per disc. If one directory has more than 2000 files, it reads up to 2000 files, the remaining files will be omitted.
- MP3/WMA CDs cannot be used for playback for the purpose of recording.
- It may take more than one minute for this unit to read MP3/WMA/JPEG files depending on its structure.

- Music recorded by “Joliet Recording Specification” can be played back.
- The music files recorded by “Hierarchical File System” (HFS) cannot be played.
- The unit can play back baseline and progressive JPEG files.

Limitations on display

- The maximum number for display is 15 characters. Long file names will be condensed.
- Available letters for display are the following: capital or lowercase letters A through Z, numbers 0 through 9, and _ (underscore).
- Other letters than those above are replaced by a hyphen.

Notes on MP3/WMA/JPEG files

To play back MP3/WMA/JPEG CD in the recorded order,

1. Use MP3/WMA/JPEG software that records data alphabetically or numerically.
2. Name each file including a two-digit or three-digit number (e.g. “01” “02” or “001” “002”).
3. Refrain from making too many sub-folders.

CAUTION:

- Some MP3/WMA/JPEG CDs cannot be played back depending on the recording conditions.
- A CD-R/RW that has no music data or non-MP3/WMA/JPEG/DivX® files cannot be played back.

MP3/WMA/JPEG CD and Audio CD playback:

- 1 Load a MP3/WMA/JPEG CD or an Audio CD in the disc slot.
- 2 “Reading” will appear on the TV screen. Reading time will depend on the number of files on the disc.
- 3 A file browser screen will appear on the TV screen.

Operation status File number Elapsed time Selected file name

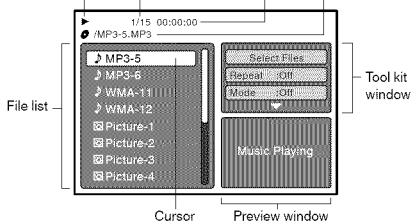

File type

- ▶ : Indicates Music file (Audio CD/MP3/WMA)
- 📁 : Indicates Picture file (JPEG)

- In case the current directory includes 9 files or more, press ▲ or ▼ to scroll in the file list.
- To see contents in folder, select the folder and then press ENTER. To return to the parent directory, select “Go Up ...” then press ENTER.
- In case of a CD containing a mixture of MP3, WMA and JPEG files, the files are played back by selecting them from the file browser.

- 4 Press ▲ or ▼ to select the desired file.

When **PLAY** is pressed after displaying file browser displayed, playback begins automatically starting from the first file.

In this case, if the first file is an MP3/WMA file, only MP3/WMA files are played back in order. If the first file is a JPEG file, the first JPEG file is played back. If there is no file at a root directory, playback does not begin automatically.

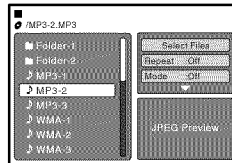

- 5 Press **ENTER**.

The selected file starts playing back.

- 6 Press **STOP** to end playback.

- The unit records the stopped point. “■” appears on the screen. Press **PLAY** to resume playback (from the scene point).
- If you press **STOP** again or unload the disc, the unit will clear the stopped point.

NOTE:

- During MP3/WMA/JPEG-Playback, you cannot use JUMP and A-B Repeat functions.
- You can use Program playback, Repeat (Track or All) and Random functions for MP3/WMA/JPEG and Audio CD Playback (see pages 29 and 30).

JPEG playback:

- 1 In the file browser, press▲/▼ to select the desired JPEG file.

To display a thumbnail list, press **DVD MENU**.

Press ▲/▼/◀/▶ to select the desired file.

(To return to the file browser, press **TOP MENU**.)

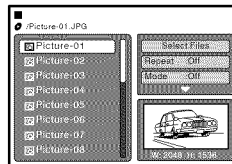

- 2 Press **ENTER** or **PLAY**.

The selected picture appears on the TV screen.

Rotating an image

You can rotate an image by 90 degrees.

Press **ANGLE** during playback of the image.

“■”, “▶”, “◀”, “■” appears on the screen.

Zooming an image

Zoom function also can be used in viewing JPEG files.

Press **ZOOM** (See “Zooming” on page 30).

- 3 Press **STOP** to end playback.

The file browser appears on the TV screen.

If you want to watch the other file, repeat steps 1-2.

Select Files

The file type to make it display in the file browser can be chosen.

- 1 Press **◀/▶** to select "Select Files" at right column in the file browser.
 - Press **ENTER**, then press **▲/▼** to select file type from the list (Music or Picture).
- 2 Press **ENTER** to add/remove check mark. Checked file type will be displayed in the file browser.
- 3 Press **RETURN** to save the setting.

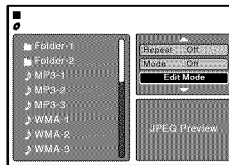

- 2 Press **▲/▼/◀/▶** to select the file you want to add into the program list.

Press **ENTER**. Selected file was marked. Repeat this procedure to select the other files.

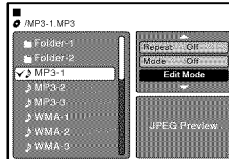

- 3 Press **▲/▼/◀/▶** to select "Add To Program". Then press **ENTER**. All marked files are added into the program list.

When you finish storing the files you want into the Program list, select "Edit Mode" again and press **ENTER** to release edit mode.

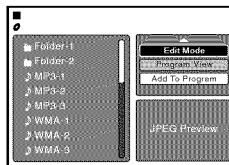

- 4 Press **▲/▼** to select "Program View", then press **ENTER**. Program View shows only the programmed files that you have added in Step 2.

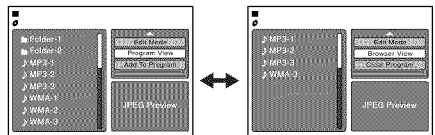

- 5 In the Program View, press **PLAY**. The files start to playback in programmed order that were added by you.

To remove file from program list in stop mode
In the Edit Mode, switch to Program View. Select the files you want to remove, then press **ENTER**. Select "Clear Program" and press **ENTER**. Marked file is removed from program list.

NOTE:

- The program is cancelled when you eject the disc or turn the power off.

Setting the JPEG interval

You can continuously play back all JPEG files automatically.

- 1 Press **SETUP/TV MENU** in the stop mode. Press **▲** or **▼** to select option, then press **◀/▶** or **ENTER**.
- 2 Press **▲** or **▼** to select "JPEG Interval", then press **▶** or **ENTER**.
- 3 Press **▲** or **▼** to select your desired time, then press **ENTER**.

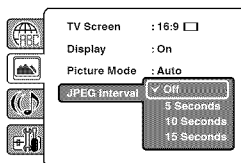

Off:

Plays back one file at a time.

5 Seconds:

Plays back images in the form of a slide show at 5 second intervals.

10 Seconds:

Plays back images in the form of a slide show at 10 second intervals.

15 Seconds:

Plays back images in the form of a slide show in 15 second intervals.

- 4 Press **SETUP/TV MENU** to remove the menu screen.

Program playback (CD)

You can arrange the order of tracks on the disc.

- 1 In the file browser, press **▲/▼/◀/▶** to select "Edit Mode", then press **ENTER**.

When "Edit Mode" is black color, you can mark the files which you want to add into Program list.

Repeat playback (CD)

- 1 In the file browser, press ▲/▼/◀/▶ to select "Repeat".
- 2 Press **ENTER** repeatedly to select "Track" or "All".

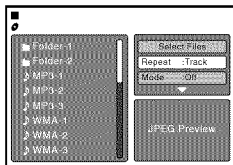

- 3 Press **PLAY**.
The unit automatically starts repeat playback after finishing the current track.
To resume normal playback, select Repeat : "Off" in step 2.

NOTE:

- The repeat or random function is canceled when you eject the disc or turn the power off.
- The track repeat function is canceled when **SKIP** ◀◀ or ▶▶ is pressed.
- In case of Audio CD, the function of A-B Repeat also can be used (See "A-B Repeat playback" on page 31).

Random playback (CD)

- 1 In the file browser, press ▲/▼/◀/▶ to select "Mode".
- 2 Press **ENTER** to select "Random".

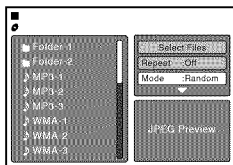

- 3 Press **PLAY**.
The Random playback will start.
To resume normal playback, select Mode : "Off" in step 2.

Zooming

This unit will allow you to zoom in on the frame image. You can then make selections by switching the position of the frame.

- 1 Press **ZOOM** during playback.
The center part of the image will be zoomed in. Each press of **ZOOM** will change the ZOOM magnification Q₁ (x 1.3), Q₂ (x 1.5) and Q₃ (x 2.0).

- 2 Press ▲/▼/◀/▶ to view a different part of the frame.
You may move the frame from the center position UP, DOWN, LEFT or RIGHT.
- 3 In the zoom mode press **ZOOM** repeatedly to return to a 1:1 view (Q Off).

NOTE:

- You can select the Pause, Slow or Search playback in the zoom mode.
- Some discs may not respond to zoom feature.

Locating desired scene

Use the title, chapter and time recorded on the disc to locate the desired point to playback.

- 1 Press **JUMP** during playback or resume stop mode.

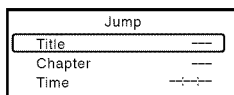

- 2 Press ▲ or ▼ to select the "Title", "Chapter" or "Time".
- 3 Press **Number buttons (0-9)** to input the number.
 - If you input a wrong number, press **CANCEL**.
 - Refer to the package supplied with the disc to check the numbers.
- 4 Press **ENTER**.
 - Playback starts.
 - When you change the title, playback starts from Chapter 1 of the selected title.
 - Some discs may not work in the above operation.

Repeat playback

Title, Chapter Playback:

- 1 Press **PLAY MODE** during playback or stop mode.
- 2 Press **ENTER** repeatedly to select "Chapter" or "Title".
The unit automatically starts repeat playback after finishing the current title or chapter.
 - If you set the repeat mode during stop mode, press **PLAY** to start Repeat playback.

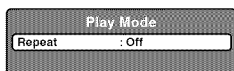

- 3 Press **PLAY MODE** again to make the screen disappear.
 - In stop mode, press **PLAY** to start Repeat playback.
 - To resume normal playback, select Repeat "Off" in step 2.

A-B Repeat Playback:

A-B repeat playback allows you to repeat material between two selected points.

- 1 Press **REPEAT A-B** during playback.
The start point is selected.



- 2 Press **REPEAT A-B** again.
The end point is selected. Playback starts at the point that you selected. Playback stops at the end point, returns to Point A automatically, then starts again.

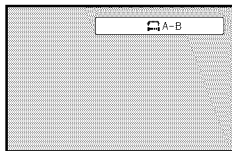

- 3 To resume normal playback press **REPEAT A-B** again.
"Off" appears on the screen.

NOTE:

- Some discs may not work with the repeat operation.
- In A-B repeat mode, subtitles near point A or B may not appear.
- During the A-B Repeat Playback the ANGLE feature will not operate.
- You may not be able to set A-B Repeat, depending on the scenes of the DVD.
- A-B Repeat does not work with an interactive DVD, MP3/WMA/JPEG-CD.

Marking desired scenes

The TV/DVD stores the points that you want to watch again. You can resume playback from that scene.

Marking the scenes:

- 1 Press **MARKER** during playback.
- 2 Select the blank Marker using **▲** or **▼**, then press **ENTER** at the desired scene.

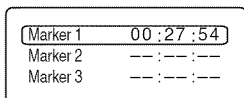

- Up to 3 scenes can be selected.
 - Repeat this procedure to set the other 2 scenes.
- 3 Press **MARKER** to remove this display.

Returning to the scenes:

- 1 Press **MARKER** during playback or stop mode.
- 2 Press **▲** or **▼** to select the Marker 1-3.

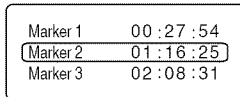

- 3 Press **ENTER**.
Playback starts from the marked scene.

To cancel the mark:

- 1 Press **MARKER** during playback or stop mode.
- 2 Press **▲** or **▼** to select the Marker 1-3.
- 3 Press **CANCEL**.
Press **MARKER** to remove this display.

NOTE:

- The marking is canceled when you eject the disc or turn the power off.
- Some subtitles recorded around the marker may fail to appear. [DVD]

Changing soundtrack language

You can select the language when you play a multilingual disc.

- 1 Press **AUDIO** during playback.
The current soundtrack language will appear.

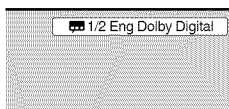

- 2 Press **AUDIO** repeatedly until the desired language is selected.

The on-screen display will disappear after a few seconds.

NOTE:

- If the desired language is not heard after pressing **AUDIO** several times, the language is not recorded on the disc.
- Changing soundtrack language is cancelled when you eject the disc.
The initial default language or available language will be heard if the disc is played back again.

Subtitles

Turning the subtitles on and off

When playing back a disc recorded with subtitles, you can turn the subtitles on or off.

Press **SUBTITLE** during playback until "Off" appears.

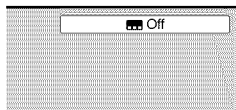

Changing the subtitle language

You can select the language when playing back a disc recorded with multilingual subtitles.

1 Press **SUBTITLE** repeatedly during playback until your desired language appears.



2 The on-screen display will disappear after a few seconds.

NOTE:

- Changing subtitle language is cancelled when you eject the disc.
- Some functions may not work on some DVDs. You may not be able to turn subtitles on or off or change subtitles. While playing the DVD, the subtitle may change when:
 - you eject the disc.
 - you change the title.
- In some cases, the subtitle language is not changed to the selected one immediately.

Changing angles

When playing back a disc recorded with multi-angle facility, you can change the view angle.

1 Press **ANGLE** during playback.

The current angle will appear.

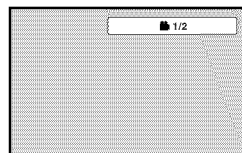

2 Press **ANGLE** repeatedly until the desired angle is selected.

NOTE:

- Depending on the DVD, you may not be able to change the angles even if multi-angles are recorded on the DVD.

Title selection

Two or more titles are recorded on some discs. If the title menu is recorded on the disc, you can select the desired title.

- 1 Press **TOP MENU** during playback. Title menu appears on the screen.
- 2 Press **▲/▼** or **◀/▶** to select the desired title.
- 3 Press **ENTER** or **PLAY**. The playback of the selected title will start.

NOTE:

- Depending on the DVD, you may not be able to select the title. Depending on the DVD, a "title menu" may simply be called a "menu" or "title" in the instructions supplied with the disc.

DVD menu

Some DVDs allow you to select the disc contents using the menu.

When you playback these DVDs, you can select the subtitle language and soundtrack language, etc. using the DVD menu.

- 1 Press **DVD MENU** during playback. The DVD menu appears on the screen.
 - Press **DVD MENU** again to resume playback at the scene when you pressed **DVD MENU**.
- 2 Press **▲/▼** or **◀/▶** to select the desired item.
- 3 Press **ENTER**. The menu continues to another screen. Repeat steps 2 and 3 to set additional items if any.

Setting the language

You can select the language of "Menu", "Subtitle" and "Audio" if more than one languages are recorded onto the disc.

- 1 Press **SETUP/TV MENU** in the stop mode. Press **▲** or **▼** to select  option, then press **◀/▶** or **ENTER**.
- 2 Press **▲** or **▼** to select desired option, then press **▶** or **ENTER**.
- 3 Press **▲** or **▼** to select your desired language (e.g. English), then press **ENTER**.

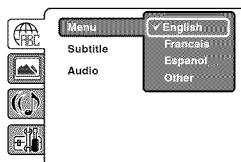

English, Francais, Espanol :

The selected language will be heard or seen.

Other:

Other language can be selected (see the "Language code list" on page 36).

Original (Audio):

The unit will select the first priority language of each disc.

Off (Subtitle):

Subtitles do not appear.

- 4 Press **SETUP/TV MENU** to remove the menu screen.

NOTE:

- If the selected language is not recorded on the disc, the first priority language is selected.

Setting the aspect ratio of TV screen

You can select the aspect ratio of the picture.

- 1 Press **SETUP/TV MENU** in the stop mode or No Disc.
Press **▲** or **▼** to select  option, then press **◀/▶** or **ENTER**.
- 2 Press **▲** or **▼** to select "TV Screen", then press **▶** or **ENTER**.
- 3 Press **▲** or **▼** to select your desired screen type, then press **ENTER**.

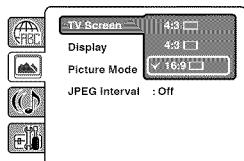

You have the following screen sizes to choose from:

4:3 Letterbox

When playing back a wide screen DVD disc, it displays the wide picture with black bands at the top and bottom of screen.

4:3 Panscan

It displays the wide picture on the whole screen with left and right edges automatically cut off.

16:9 Wide

A wide screen picture is displayed full size.

- 4 Press **SETUP/TV MENU** to remove the menu screen.

NOTE:

- It is not always possible for the DVD disc to display the picture as per your preferred picture setting - for example, if you select "4:3 Panscan", the disc may not offer this option. In this case the picture would display the format the disc is capable of playing back.

Setting on screen display

On screen display can be switched on or off when you press the any button.

- 1 Press **SETUP/TV MENU** in the stop mode or No Disc.
Press **▲** or **▼** to select  option, then press **◀/▶** or **ENTER**.
- 2 Press **▲** or **▼** to select "Display", then press **▶** or **ENTER**.
- 3 Press **▲** or **▼** to select "On" or "Off", then press **ENTER**.

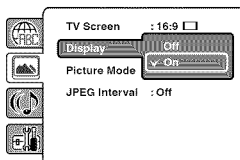

On: On screen displays appear when you press the buttons (factory setting).

Off: On screen displays do not appear when you press any buttons except **SUBTITLE**, **PLAY MODE**, **MARKER**, **DISPLAY**, **AUDIO** and **JUMP**.

- 4 Press **SETUP/TV MENU** to remove the menu screen.

Setting the picture mode

There are two types of source content in pictures recorded in DVD video discs: film content (pictures recorded from films at 24 frames per second) and video content (video signals recorded at 30 frames per second). Make this selection according to the type of content being viewed.

- 1 Press **SETUP/TV MENU** in the stop mode or No Disc.
Press **▲** or **▼** to select  option, then press **◀/▶** or **ENTER**.
- 2 Press **▲** or **▼** to select "Picture Mode", then press **▶** or **ENTER**.
- 3 Press **▲** or **▼** to select your desired picture mode, then press **ENTER**.

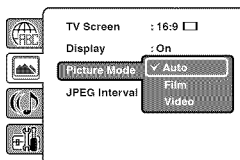

Auto:

Select this position normally.
The DVD player automatically detects source content, film or video, of playback source.

Film:

Suitable for playback of film content pictures.

Video:

Suitable for playback of video content pictures.

- 4 Press **SETUP/TV MENU** to remove the menu screen.

NOTE:

- Depending on the disc, pictures may be cut off or doubled. In this case, select "Video".

Night mode

Night Mode enables you to control the dynamic range so as to achieve a suitable sound for your equipment.

- 1 Press **SETUP/TV MENU** in the stop mode or No Disc.
Press **▲** or **▼** to select  option, then press **◀/▶** or **ENTER**.
- 2 Press **▲** or **▼** to select "Night Mode", then press **▶** or **ENTER**.
- 3 Press **▲** or **▼** to select "On" or "Off", then press **ENTER**.
On : Loud sounds such as explosions are toned down slightly when played.
Off : The unit will play the disc as recorded.

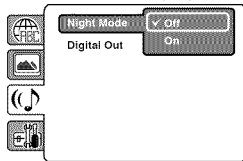

- 4 Press **SETUP/TV MENU** to remove the menu screen.

Digital out

You can select the digital output sound format corresponding to your system connection.

- 1 Press **SETUP/TV MENU** in the stop mode or No Disc.
Press **▲** or **▼** to select  option, then press **◀/▶** or **ENTER**.
- 2 Press **▲** or **▼** to select "Digital Out", then press **▶** or **ENTER**.
- 3 Press **▲** or **▼** to select "Off", "PCM" or "Bitstream", then press **ENTER**.

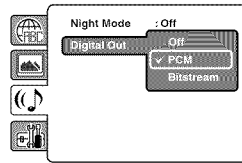

Off: There is no sound output from DIGITAL AUDIO OUT jack.

PCM: Change Dolby Digital to PCM for the output. Select when connected to a 2 channel digital stereo amplifier.

Bitstream: Disc audio bitstream data will be output.

- 4 Press **SETUP/TV MENU** to remove the menu screen.

NOTE:

- This function works only during playback of Dolby Digital recorded discs.
- The level of Dynamic Range Reduction may differ depending on DVD video disc.
- Even if you select "Bitstream", MPEG audio will be output in PCM format.

Parental control

Some discs are specified not suitable for children. Such discs can be limited not to play back with the unit.

Password and setting:

- 1 Press **SETUP/TV MENU** in the stop mode or No Disc.
Press **▲** or **▼** to select  option, then press **◀/▶** or **ENTER**.
- 2 Press **▲** or **▼** to select "Parental", then press **▶** or **ENTER**.
"Enter Password" screen will appear.
- 3 Press "0000" using **Number buttons (0-9)**. (This is pre-setting password of this unit). Then press **ENTER**.
 - If you input a wrong number, press **CANCEL**.

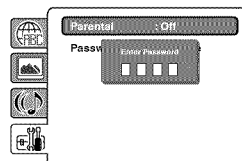

- 4 The parental level list will appear. Press **▲** or **▼** to select the level 1 to level 8. The limitation will be more severe as the level number is lowered. Then press **ENTER**.

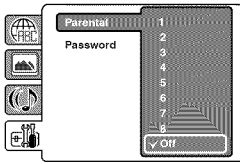

- **Level Off** : The parental control setting does not function.
- **Level 8** : Virtually all DVD software can be played back.
- **Level 1** : DVD software for adults cannot be played back.

5 Press **SETUP/TV MENU** to remove the menu screen.

NOTE:

- If each setup (P.32~35) has been completed, the unit will use these settings during DVD playback. Each setup will be retained in memory.
- Depending on the discs, the unit may not be able to limit playback.
- Some discs may not be encoded with specific rating level information though its disc jacket says "adult". For those discs, the age restriction will not work.
- After the rating is locked, the setting cannot be changed unless you enter the correct password.

Setting the new password:

- 1 Press **SETUP/TV MENU** in the stop mode or No Disc. Press **▲** or **▼** to select  option, then press **◀/▶** or **ENTER**.
- 2 Press **▲** or **▼** to select "Password", then press **▶** or **ENTER**. "Enter Current Password" screen will appear.
- 3 Press **Number buttons (0-9)** to enter the password you have stored.
 - If you input a wrong number, press **CANCEL**.
- 4 Then press **ENTER**. "Enter New Password" screen will appear. Press **Number buttons (0-9)** to input the new password.

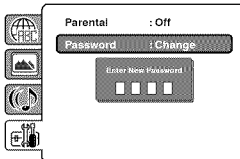

- 5 Press **ENTER**. Now your new password has been set. Be sure to remember this number!

NOTE:

- Do not forget the password. If you forget the password, contact Customer Service at 1-800-289-0980. The original remote control will be required.

Temporary disabling of rating level by DVD disc

Some pre-recorded DVD discs may attempt to temporarily cancel the rating level that you have set. You will be given the option to allow or not allow the override.

- 1 Load a DVD disc (see page 26).
- 2 If the DVD disc has been designed to temporarily cancel the Rating level, the screen which follows the "Reading" screen will change, depending on which disc is played. If you select "YES" with **ENTER** key, password input screen will then appear.
- 3 Enter the password with **Number buttons (0-9)**. Then press **ENTER**.
 - If you interrupt the entering, press **RETURN**.

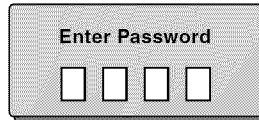

- 4 Playback will commence if the entered password was correct.

NOTE:

- This temporary cancellation of the rating level will be kept until the disc is ejected. When the disc is ejected, the original rating level will be set again automatically.

Language code list

Enter the appropriate code number for the initial settings “Menu”, “Subtitle” and/or “Audio” (see page 32).

Language Name	Code	Language Name	Code	Language Name	Code	Language Name	Code
Abkhazian	1112	Fiji	1620	Lingala	2224	Sinhalese	2919
Afar	1111	Finnish	1619	Lithuanian	2230	Slovak	2921
Afrikaans	1116	French	1628	Macedonian	2321	Slovenian	2922
Albanian	2927	Frisian	1635	Malagasy	2317	Somali	2925
Amharic	1123	Galician	1722	Malay	2329	Spanish	1529
Arabic	1128	Georgian	2111	Malayalam	2322	Sundanese	2931
Armenian	1835	German	1415	Maltese	2330	Swahili	2933
Assamese	1129	Greek	1522	Maori	2319	Swedish	2932
Aymara	1135	Greenlandic	2122	Marathi	2328	Tagalog	3022
Azerbaijani	1136	Guarani	1724	Moldavian	2325	Tajik	3017
Bashkir	1211	Gujarati	1731	Mongolian	2324	Tamil	3011
Basque	1531	Hausa	1811	Nauru	2411	Tatar	3030
Bengali; Bangla	1224	Hebrew	1933	Nepali	2415	Telugu	3015
Bhutani	1436	Hindi	1819	Norwegian	2425	Thai	3018
Bihari	1218	Hungarian	1831	Oriya	2528	Tibetan	1225
Breton	1228	Icelandic	1929	Panjabi	2611	Tigrinya	3019
Bulgarian	1217	Indonesian	1924	Pashto, Pushto	2629	Tonga	3025
Burmese	2335	Interlingua	1911	Persian	1611	Turkish	3028
Byelorussian	1215	Irish	1711	Polish	2622	Turkmen	3021
Cambodian	2123	Italian	1930	Portuguese	2630	Twi	3033
Catalan	1311	Japanese	2011	Quechua	2731	Ukrainian	3121
Chinese	3618	Javanese	2033	Rhaeto-Romance	2823	Urdu	3128
Corsican	1325	Kannada	2124	Romanian	2825	Uzbek	3136
Croatian	1828	Kashmiri	2129	Russian	2831	Vietnamese	3219
Czech	1329	Kazakh	2121	Samoan	2923	Volapük	3225
Danish	1411	Kirghiz	2135	Sanskrit	2911	Welsh	1335
Dutch	2422	Korean	2125	Scots Gaelic	1714	Wolof	3325
English	1524	Kurdish	2131	Serbian	2928	Xhosa	3418
Esperanto	1525	Laothian	2225	Serbo-Croatian	2918	Yiddish	2019
Estonian	1530	Latin	2211	Shona	2924	Yoruba	3525
Faroese	1625	Latvian, Lettish	2232	Sindhi	2914	Zulu	3631

Connections to other equipment

The exact arrangement you use to interconnect various video and audio components to this unit is dependent on the model and features of each component. Check the Owner's Manual provided with each component for the location of video and audio inputs and outputs.

To connect the LCD TV/DVD to a VCR

Rear of the unit

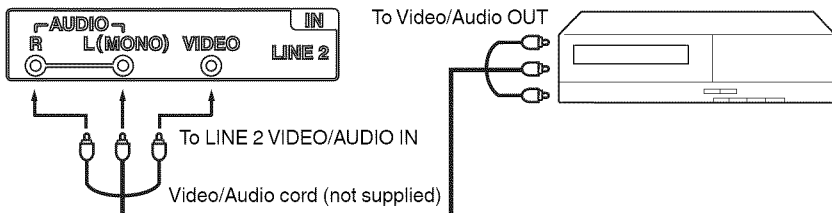

To connect the LCD TV/DVD to a VCR with an S-Video cord

If you connect a VCR with a S-Video cable to the S-VIDEO IN jack on the rear side of the unit, you must also connect the audio cables to the AUDIO IN jacks on the rear side of the unit. The S-Video cable only carries the video signal. The audio signal is separate.

NOTE:

- When the S-Video cable and the standard video cable are connected at the same time, the S-Video cable takes precedence.

Rear of the unit

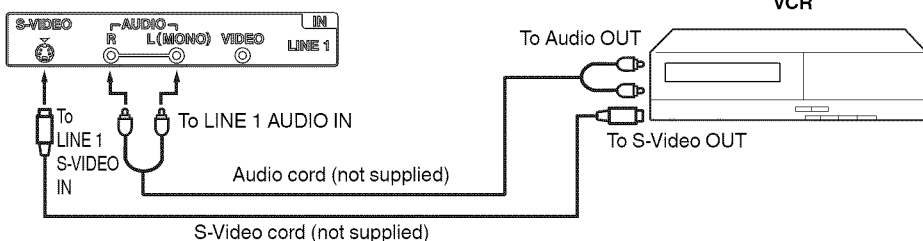

To connect to a DVD player with Component Video Input

You can enjoy a high quality picture by connecting the unit's COMPONENT VIDEO OUT jacks of your DVD player with the COMPONENT video cables (not supplied).

Rear of the unit

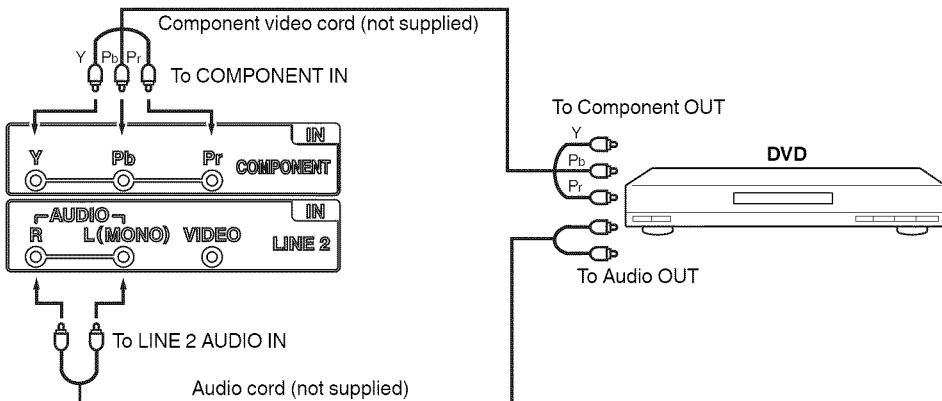

NOTE:

- Component Video input of the unit are for use with a device which output 480i/1080i interlaced signals and 480p/720p progressive signals.

To connect a HDMI or a DVI device to the unit

The HDMI 1 input receives digital audio and uncompressed video from a HDMI device or uncompressed digital video from a DVI device.

When you connect to a DVI device with a HDMI-to-DVI adapter cable, it transfers only video signal. Separate analog audio cords required.

Rear of the unit

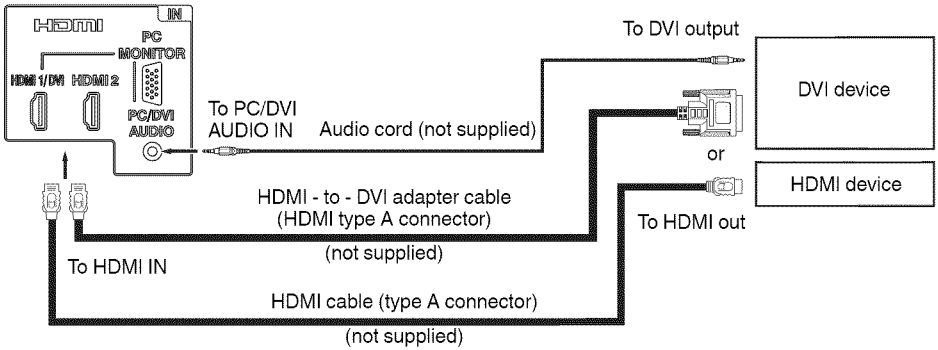

NOTE:

- When using HDMI 1/DVI to connect your HDMI or DVI devices, you must select the corresponding audio input source (HDMI or DVI) on the menu screen (see “Selecting the HDMI audio input source” on page 25). Otherwise you will only see the image with no sound.
- If you connect an external component (cable box, satellite receiver, etc.) to this LCD TV using an HDMI cable or a DVI to HDMI cable, the image will not display if the output resolution of the component is set to 480i. To receive the picture you must change the output resolution on the external component. Should you require further instruction, please contact the manufacturer of the external component.

Using an AV Amplifier with built-in digital surround

If you are using an Amplifier with built-in digital surround sound, you can enjoy various audio systems including Dolby Digital Surround audio that sounds just like the movie.

Connect an AV amplifier with built-in Dolby Digital decoder, DTS decoder, or MPEG decoder etc. as shown below.

Rear of the unit

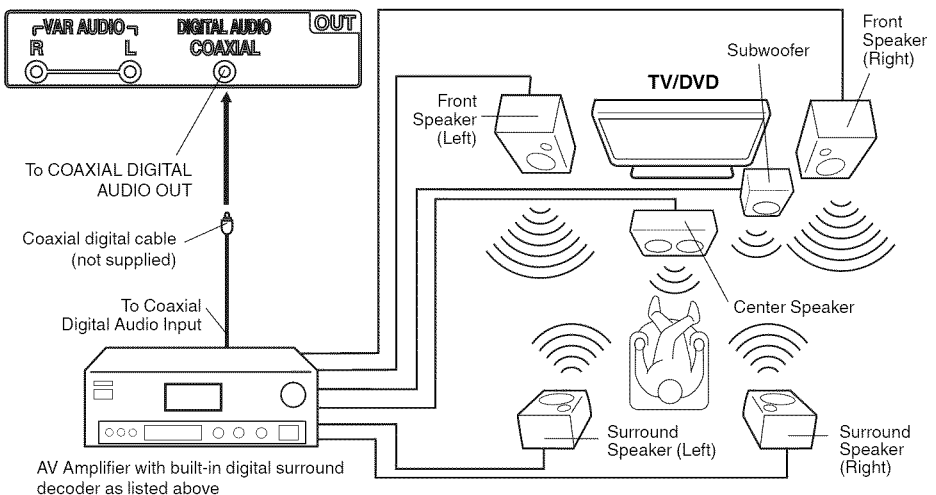

NOTE:

- When you are viewing digital broadcast, this unit will not work in conjunction with DTS audio or MPEG audio. There will be no sound output if connected to an AV amplifier with a built-in DTS decoder or MPEG decoder.

To connect an audio system

This connection allows you to use an audio amplifier and external speakers, and adjust the audio level using the TV's remote control.

To control the audio, turn on the TV and the stereo amplifier, and turn off the TV's built-in speakers (see "Turning off the built-in speakers" on page 25).

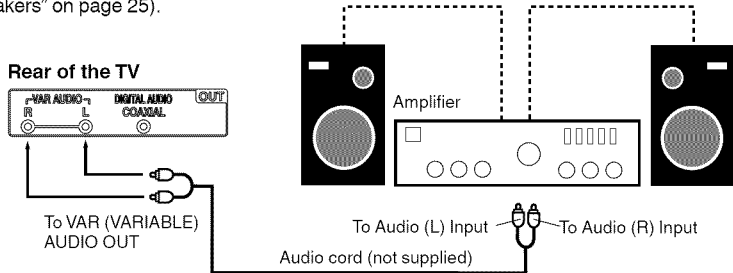

NOTE:

To hear sound when using an external audio amplifier, the volume of both the TV and the amplifier must be set above 0 (zero).

For example, if the volume of the TV is set to 0, you will not be able to hear any sound, even if the volume of the amplifier is at its highest level.

To connect the TV/DVD to a camcorder, or a TV Game

To playback from a camcorder, connect the camcorder to the unit as shown.

This unit can also be used as a display device for many video games. However, due to the wide variety of signals generated by these devices and subsequent hook-up variations required, they have not all been included in the suggested connection diagrams. You'll need to consult each component's Owner's Manual for additional information.

Rear of the unit

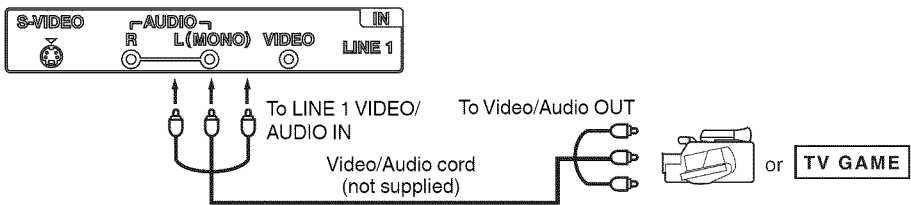

To connect the TV/DVD to a PC (Personal Computer)

Before you connect this TV/DVD to your PC, change the adjustment of your PC's Resolution and Refresh rate (60 Hz).

Connect one end of a (male to male) VGA cable to the video card of the computer and the other end to the VGA connector PC MONITOR on the rear of the TV/DVD. Attach the connectors firmly with the screws on the plug. In case of a Multimedia computer, connect the audio cord to the audio output of your Multimedia computer and to the AUDIO connector of the PC/DVI AUDIO IN jack of the TV/DVD. You can also connect the PC with HDMI cable. If you use HDMI cable, you don't have to connect the audio cord. If you use DVI-to-HDMI cable, please connect audio cord as same way as VGA cable.

Press **INPUT SELECT** on the remote control to select PC mode.

Switch on the computer. The TV/DVD can operate as the computer monitor.

Rear of the unit

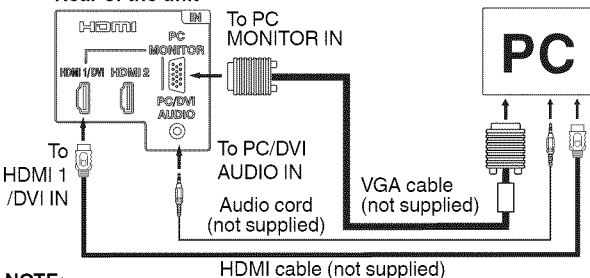

Monitor Display modes

MODE	Resolution	Refresh rate
VGA	640x480	60/ 72/ 75 Hz
VGA	720x400	70Hz
SVGA	800x600	56/ 60/ 72/ 75 Hz
XGA	1024x768	60/ 70/ 75 Hz
WXGA	1280x768	60Hz
WXGA	1280x720	60Hz
WXGA	1360x768	60Hz

To return to normal mode
Press **INPUT SELECT** again.

NOTE:

- The on-screen displays will have a different appearance in PC mode than in TV mode.
- If there is no video signal from the PC when the unit is in PC mode, "No signal" will appear on the TV-screen.

Reception disturbances

Most types of television interference can be remedied by adjusting the height and position of the VHF/ UHF antenna. Outdoor antennas are recommended for best results. The most common types of television interference are shown below. If one of these symptoms appear when the TV is connected to a Cable TV system, the disturbance may be caused by the local Cable TV company broadcast.

IGNITION

Black spots or horizontal streaks may appear, the picture may flutter or drift. Usually caused by interference from automobile ignition systems, neon lamps or AC powered tools and appliances such as drills or hair dryers.

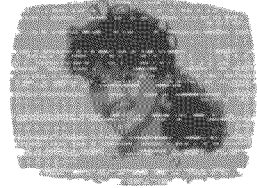

GHOSTS

Ghosts are caused by the television signal following two paths. One is the direct path and the other is reflected by tall buildings, hills or other large objects. Changing the direction or position of the antenna may improve the reception.

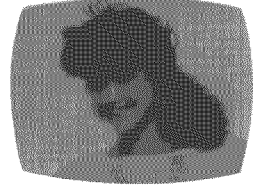

SNOW

If the TV is located far from the TV station, in a fringe reception area where the signal is weak, small dots may appear in the picture. If the signal is extremely weak, the installation of a larger external antenna may be necessary.

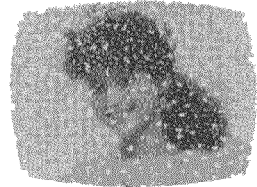

RADIO FREQUENCY INTERFERENCE (RFI)

Caused by two-way radios, this type of interference produces moving ripples or diagonal streaks in the picture. Some cases may cause a loss of contrast in the picture. Changing the direction and position of the antenna or installing an RFI filter may improve the picture.

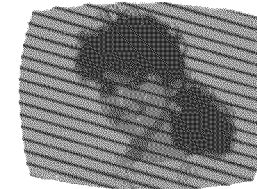

PICTURE SIZE VARIATION

A slight picture size variation is normal when you adjust the CONTRAST or BRIGHTNESS settings.



CARE AND MAINTENANCE

To prevent fire or shock hazard, disconnect the TV from the power source before cleaning. The finish on the cabinet may be cleaned with mild soap and a soft, damp cloth and cared for as other furniture. Use caution when cleaning or wiping the plastic parts.

Problems and troubleshooting

Use the following check list for troubleshooting when you have problems with your TV/DVD. Consult your local dealer or service outlet if problems persist.

Be sure all connections are properly made when using with other units.

SYMPTOMS	POSSIBLE SOLUTIONS	PAGE
POWER		
TV/DVD does not operate.	<ul style="list-style-type: none"> • Make sure the power cord is plugged in. • Power is off, check fuse or circuit breaker. • Unplug unit, then plug it back in. 	12
TV BROADCAST RECEPTION		
Poor sound or no sound.	<ul style="list-style-type: none"> • Station or Cable TV experiencing problems, tune to another station. • Check Volume adjustments or muting. • Check for sources of possible interference. 	17 17, 18 40
Poor picture or no picture.	<ul style="list-style-type: none"> • Station or Cable TV experiencing problems, tune to another station. • Check antenna or Cable TV connections, reorient antenna. • Check for sources of possible interference. • Check picture control adjustments. 	17 13, 14 40 21, 22
Poor reception on some channels.	<ul style="list-style-type: none"> • Station or Cable TV experiencing problems, tune to another station. • Station signal is weak, reorient antenna to receive stronger station. • Check for sources of possible interference. 	17 13 40
Poor color or no color.	<ul style="list-style-type: none"> • Station or Cable TV experiencing problems, tune to another station. • Make sure channels are set into memory. • Check picture control adjustments. • Check antenna or Cable TV connections, reorient antenna. • Check for sources of possible interference. 	17 15 21, 22 13, 14 40
Picture wobbles or drifts.	<ul style="list-style-type: none"> • Station or Cable TV experiencing problems, tune to another station. • Make sure channels are set into memory. • Cable TV company is scrambling signal. • Check antenna orientation. 	17 15 - 13
No Cable TV reception.	<ul style="list-style-type: none"> • Check all Cable TV connections. • Set Signal Type option to the "Cable" mode. • Station or Cable TV system problems, try another station. 	14 15 17
Horizontal or diagonal bars on screen.	<ul style="list-style-type: none"> • Check antenna connections, reorient antenna. • Check for sources of possible interference. 	13 40
No reception above channel 13.	<ul style="list-style-type: none"> • Make sure Signal Type option is in the appropriate mode. • If using antenna, check UHF antenna connections. 	15 13
TV shuts off.	<ul style="list-style-type: none"> • No broadcast on station tuned. • Sleep Timer is set. • Power interrupted. 	17 18 -
Closed - Caption is not activated.	<ul style="list-style-type: none"> • TV station experiencing problems or program tuned is not closed captioned. Try another channel. • Check Cable TV connection or VHF/UHF antenna, reposition or rotate antenna. • Set Closed caption in the menu. 	17 13, 14 20, 21
Display is not shown in your language.	<ul style="list-style-type: none"> • Select proper language in the menu options. 	15

- The LCD panel is a very high technology product, giving you fine picture details. Occasionally, a few non-active pixels may appear on the screen as a fixed point of blue, green or red. Please note that this does not affect the performance of your product.

SYMPTOMS	POSSIBLE SOLUTIONS	PAGE
DVD		
Playback doesn't start.	<ul style="list-style-type: none"> No disc is inserted. The disc may be dirty. Clean up the disc. The unit cannot play CD-ROMs, etc. 	26 8 8
No picture.	<ul style="list-style-type: none"> TV/DVD selector is not set correctly. 	26
No sound.	<ul style="list-style-type: none"> Check the input selector of the amplifier is set properly. The unit is in the Special playback mode. Select the correct Audio Output position on AV amplifier. 	– 27 39
Picture is distorted during CUE or REVIEW.	<ul style="list-style-type: none"> The picture will be distorted occasionally. 	–
Stopping playback, search, slow-motion play, repeat play, or program play, etc. cannot be performed.	<ul style="list-style-type: none"> Some discs may not allow some functions. 	–
No on-screen display.	<ul style="list-style-type: none"> Select Display On. 	33
No surround sound.	<ul style="list-style-type: none"> The setup does not match your stereo system. 	38
The unit or remote operation key is not functioning.	<ul style="list-style-type: none"> Turn off the unit and unplug the AC power cord for several minutes, then replug it. 	12
Playback does not start when the title is selected.	<ul style="list-style-type: none"> Check the Parental setup. 	34,35
Audio soundtrack and/or subtitle language is not changed when you play back a DVD.	<ul style="list-style-type: none"> Multilingual language is not recorded on the DVD disc. 	31, 32
No subtitle.	<ul style="list-style-type: none"> Some discs have no subtitles. Subtitles are cleared. Press SUBTITLE. 	32
Angle cannot be changed.	<ul style="list-style-type: none"> Multi-angles are not recorded on the DVD disc. 	32
"X" appears on the screen.	<ul style="list-style-type: none"> The function is prohibited with the unit or the disc. 	27
REMOTE CONTROL		
The remote control does not function.	<ul style="list-style-type: none"> Aim at the remote control at the remote sensor. Operate within Approx. 15 feet or reduce the light in the room. Clear the path of the beam. The batteries are weak. Replace the batteries. Check the batteries are inserted correctly. 	12



FOR CUSTOMER SERVICE, ADDITIONAL SET-UP AND OPERATING ASSISTANCE, OR TO ORDER ACCESSORIES PLEASE CALL:

1-800-289-0980

WHEN CALLING CUSTOMER SERVICE – PLEASE HAVE YOUR MODEL NUMBER READY

OR WRITE TO:

ORION SALES, INC.

3471 N. UNION DR.

OLNEY, ILLINOIS 62450

FOR INFORMATION ON OUR OTHER PRODUCTS, OR TO ORDER ACCESSORIES ONLINE, PLEASE VISIT OUR WEBSITE AT

www.orionsalesinc.com

Specifications

Model	HDLCDVD325	HDLCDVD325A
GENERAL		
Power supply:	AC 120V 60Hz	
Power consumption:	Operation: 108W Stand by: 0.7W	
Weight:	10.8 kg (23.8 lbs)	10.4 kg (22.9 lbs)
Dimensions:	Width: 796.5 mm (31-3/8 inches) Height: 581 mm (22-7/8 inches) Depth: 214 mm (8-7/16 inches)	
Operating temperature:	5°C - 40°C	
Operating humidity:	Less than 80%	
TELEVISION		
Type:	31.51 inches (800.4 mm diagonal)	
Display method:	Transmission TFT color LCD panel	
Number of Pixels:	1366 (H) x 768 (V)	
Tuner type:	NTSC standard ATSC standard (8VSB), QAM	
Receiving channels:	VHF 2-13 UHF 14-69 CATV 14-36 (A)-(W) 37-59 (AA)-(WWW) 60-85 (AAA)-(ZZZ) 86-94 (86)-(94) 95-99 (A-5)-(A-1) 100-135 (100)-(135) 01 (4A)	
Inputs:	S-Video: Y-Input: 1.0 V (p-p), 75 ohms C-Input: 0.3 V (p-p), 75 ohms Video: (RCA) 1 V p-p/75 ohms Audio: (RCA) -8 dBm/50K ohms Component video: (Y) 1 V (p-p), 75 ohms (Pb)/(Pr) 0.7 V (p-p), 75 ohms HDMI: HDMI compliant (type A connector) HDCP compliant E-EDID compliant Suggested scan rates: 480p, 480i, 720p, 1080i, 1080p HDMI Audio: 2-channel PCM 32/44.1/48 kHz sampling frequency 16/20/24 bits per sample PC Monitor: Mini-Dsub 15pin x 1 Antenna: VHF/UHF In 75 ohms coaxial	
Outputs:	Digital audio out: 0.5 Vp-p 75 ohms terminated	
Speaker:	40.6 mm x 121.9 mm (1-5/8 inches x 4-13/16 inches), 8 ohms x 2	
Audio output power:	5.0W + 5.0W	
DVD/CD player		
Signal system:	NTSC	
Applicable disc:	1. DVD (12 cm, 8 cm) 2. CD (12 cm, 8 cm)	
Pickup:	CD: Wavelength: 790 nm Maximum output power: 7 mW DVD: Wavelength: 655 nm Maximum output power: 5 mW	
ACCESSORIES	Remote control Batteries (UM-4) x 2 AC Cord	

Designs and specifications are subject to change without notice.