

MICROWAVE HOOD COMBINATION

Use & Care Guide

For questions about features, operation/performance parts, accessories or service, call: 1-800-253-1301.

or visit our website at...
www.whirlpool.com

Table of Contents 2

Model MH6150XM

TABLE OF CONTENTS

MICROWAVE OVEN SAFETY	3
Electrical Requirements	5
PARTS AND FEATURES	5
Turntable	5
Designed Cooking Rack	6
MICROWAVE OVEN CONTROL	6
Display	6
Number Codes	7
Start/Enter	7
Off/Cancel	7
Clock	7
Tones.....	7
Timer.....	7
Child Lock	7
Vent Fan	7
Cooktop Light.....	7
Options	7
MICROWAVE OVEN USE	8
Food Characteristics	8
Cooking Guidelines	8
Cookware and Dinnerware	8
Aluminum Foil and Metal	9
Cooking Power.....	9
Cooking	10
EZ-Choice® Cooking	10
Preset Cooking.....	10
Add Minute	10
Cooking in Stages.....	11
EZ-Choice® Reheating	11
EZ-Choice® Defrosting	11
Warm Hold	12
MICROWAVE OVEN CARE	12
General Cleaning.....	12
Replacing Filters.....	13
Replacing Cooktop Light	13
Replacing Microwave Oven Light.....	13
TROUBLESHOOTING	14
ASSISTANCE OR SERVICE	15
WARRANTY	16



MICROWAVE OVEN SAFETY

Your safety and the safety of others are very important.

We have provided many important safety messages in this manual and on your appliance. Always read and obey all safety messages.



This is the safety alert symbol.

This symbol alerts you to potential hazards that can kill or hurt you and others.

All safety messages will follow the safety alert symbol and either the word "DANGER" or "WARNING." These words mean:

! DANGER

You can be killed or seriously injured if you don't immediately follow instructions.

! WARNING

You can be killed or seriously injured if you don't follow instructions.

All safety messages will tell you what the potential hazard is, tell you how to reduce the chance of injury, and tell you what can happen if the instructions are not followed.

IMPORTANT SAFETY INSTRUCTIONS

When using electrical appliances basic safety precautions should be followed, including the following:

WARNING: To reduce the risk of burns, electric shock, fire, injury to persons, or exposure to excessive microwave energy:

- Read all instructions before using the microwave oven.
- Read and follow the specific "PRECAUTIONS TO AVOID POSSIBLE EXPOSURE TO EXCESSIVE MICROWAVE ENERGY" found in this section.
- The microwave oven must be grounded. Connect only to properly grounded outlet. See "GROUNDING INSTRUCTIONS" found in this section and in the provided Installation Instructions.
- Install or locate the microwave oven only in accordance with the provided Installation Instructions.
- Some products such as whole eggs in the shell and sealed containers – for example, closed glass jars – may explode and should not be heated in the microwave oven.
- Use the microwave oven only for its intended use as described in this manual. Do not use corrosive chemicals or vapors in the microwave oven. This type of oven is specifically designed to heat, cook, or dry food. It is not designed for industrial or laboratory use.
- As with any appliance, close supervision is necessary when used by children.
- Do not operate the microwave oven if it has a damaged cord or plug, if it is not working properly, or if it has been damaged or dropped.
- The microwave oven should be serviced only by qualified service personnel. Call an authorized service company for examination, repair, or adjustment.
- See door surface cleaning instructions in the "Microwave Oven Care" section.
- To reduce the risk of fire in the oven cavity:
 - Do not overcook food. Carefully attend the microwave oven if paper, plastic, or other combustible materials are placed inside the oven to facilitate cooking.
 - Remove wire twist-ties from paper or plastic bags before placing bags in oven.
 - If materials inside the oven should ignite, keep oven door closed, turn oven off, and disconnect the power cord, or shut off power at the fuse or circuit breaker panel.
 - Do not use the cavity for storage purposes. Do not leave paper products, cooking utensils, or food in the cavity when not in use.

SAVE THESE INSTRUCTIONS

IMPORTANT SAFETY INSTRUCTIONS

- Suitable for use above both gas and electric cooking equipment.
- Intended to be used above ranges with maximum width of 36 inches.
- Clean Ventilating Hoods Frequently - Grease should not be allowed to accumulate on hood or filter.
- Oversized foods or oversized metal utensils should not be inserted in the microwave oven as they may create a fire or risk of electric shock.
- Do not clean with metal scouring pads. Pieces can burn off the pad and touch electrical parts involving a risk of electric shock.
- Do not use paper products when appliance is operated in the "PAN BROWN" mode (on models with this feature).
- Do not store any materials, other than manufacturer's recommended accessories, in this oven when not in use.
- Do not store anything directly on top of the microwave oven when the microwave oven is in operation.
- When flaming foods under the hood, turn the fan on.
- Use care when cleaning the vent-hood filter. Corrosive cleaning agents, such as lye-based oven cleaners, may damage the filter.
- Do not cover or block any openings on the microwave oven.
- Do not store this microwave oven outdoors. Do not use the microwave oven near water - for example, near a kitchen sink, in a wet basement, or near a swimming pool, and the like.
- Do not immerse cord or plug in water.
- Keep cord away from heated surfaces.
- Do not let cord hang over edge of table or counter.
- Do not mount over a sink.
- Do not cover racks or any other part of the oven with metal foil. This will cause overheating of the oven.

SAVE THESE INSTRUCTIONS

PRECAUTIONS TO AVOID POSSIBLE EXPOSURE TO EXCESSIVE MICROWAVE ENERGY...

- (a) Do not attempt to operate this oven with the door open since open-door operation can result in harmful exposure to microwave energy. It is important not to defeat or tamper with the safety interlocks.
- (b) Do not place any object between the oven front face and the door or allow soil or cleaner residue to accumulate on sealing surfaces.
- (c) Do not operate the oven if it is damaged. It is particularly important that the oven door close properly and that there is no damage to the:
 - (1) Door (bent),
 - (2) Hinges and latches (broken or loosened),
 - (3) Door seals and sealing surfaces.
- (d) The oven should not be adjusted or repaired by anyone except properly qualified service personnel.

Electrical Requirements

⚠ WARNING



Electrical Shock Hazard

Plug into a grounded 3 prong outlet.

Do not remove ground prong.

Do not use an adapter.

Do not use an extension cord.

Failure to follow these instructions can result in death, fire, or electrical shock.

Observe all governing codes and ordinances. A 120 Volt, 60 Hz, AC only, 15- or 20-amp fused electrical supply is required. (A time-delay fuse or circuit breaker is recommended.) It is recommended that a separate circuit serving only this appliance be provided.

GROUNDING INSTRUCTIONS

■ For all cord connected appliances:

The microwave oven must be grounded. In the event of an electrical short circuit, grounding reduces the risk of electric shock by providing an escape wire for the electric current. The microwave oven is equipped with a cord having a grounding wire with a grounding plug. The plug must be plugged into an outlet that is properly installed and grounded.

WARNING: Improper use of the grounding plug can result in a risk of electric shock. Consult a qualified electrician or serviceman if the grounding instructions are not completely understood, or if doubt exists as to whether the microwave oven is properly grounded.

Do not use an extension cord. If the power supply cord is too short, have a qualified electrician or serviceman install an outlet near the microwave oven.

■ For a permanently connected appliance:

This appliance must be connected to a grounded, metallic, permanent wiring system, or an equipment grounding conductor should be run with the circuit conductors and connected to the equipment grounding terminal or lead on the appliance.

SAVE THESE INSTRUCTIONS

PARTS AND FEATURES

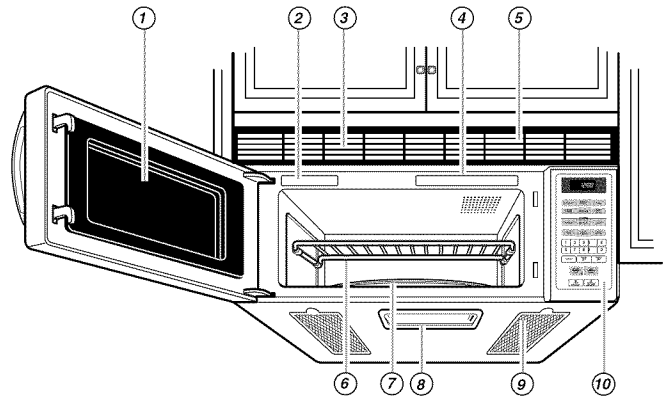

- | | |
|---|-------------------|
| 1. Metal Shielded Window | 6. Cooking Rack |
| 2. Model and Serial Number Plate | 7. Turntable |
| 3. Charcoal Filter (behind vent grille) | 8. Cooktop Light |
| 4. Cooking Guide Label | 9. Grease Filters |
| 5. Vent Grille | 10. Control Panel |

Turntable

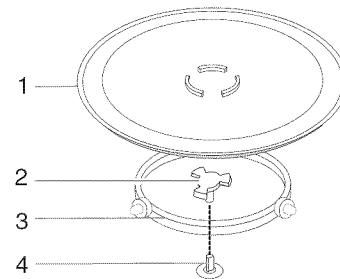

1. Turntable
2. Hub
3. Support
4. Shaft

The turntable rotates in both directions to help cook food more evenly. Do not operate the microwave oven without the turntable in place. See "Assistance or Service" to reorder any of the parts.

To Install:

1. Place the support on the oven cavity bottom.
2. Place the turntable on the support.

Fit the raised, curved lines in the center of the turntable bottom between the three spokes of the hub. The rollers on the support should fit inside the turntable bottom ridge.

The turntable can be turned off (except during an auto function). This is helpful when cooking with plates that are larger than the turntable or when cooking with two 10 in. (25 cm) plates that are side-by-side.

To turn off: Touch TURNTABLE ON/OFF. "OFF" will appear in the display. For optimal results, halfway through cooking time, turn plates for more even cooking.

Designed Cooking Rack

The cooking rack is ideal for two-level cooking. It provides extra cavity space for cooking 2 or more containers at the same time. The rack may be turned upside-down in order to fit taller containers on the bottom of the oven.

Insert the rack securely into the rack supports on the side walls of the oven. See "Assistance or Service" section to reorder rack.

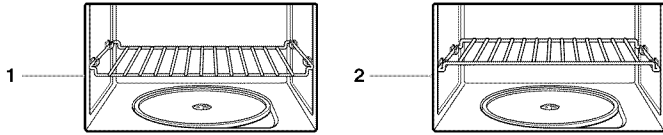

1. Right side up

2. Upside down

- Rack will become hot. Always use oven mitts or pot holders when handling.
- Do not allow the rack to touch the inside cavity walls, ceiling or floor.
- Do not use metal cookware, utensils, or a browning dish with the rack.
- Do not let food container on rack touch the top or sides of the oven.
- Do not place popcorn bags on rack.
- The rack is designed specifically for this oven. Do not use it in any other oven.
- Do not cook food directly on the rack. Always use a microwave-safe container.
- Use the rack only when cooking on two levels. Do not store it in the oven. Damage to the oven could result if someone accidentally turns on the oven.

MICROWAVE OVEN CONTROL

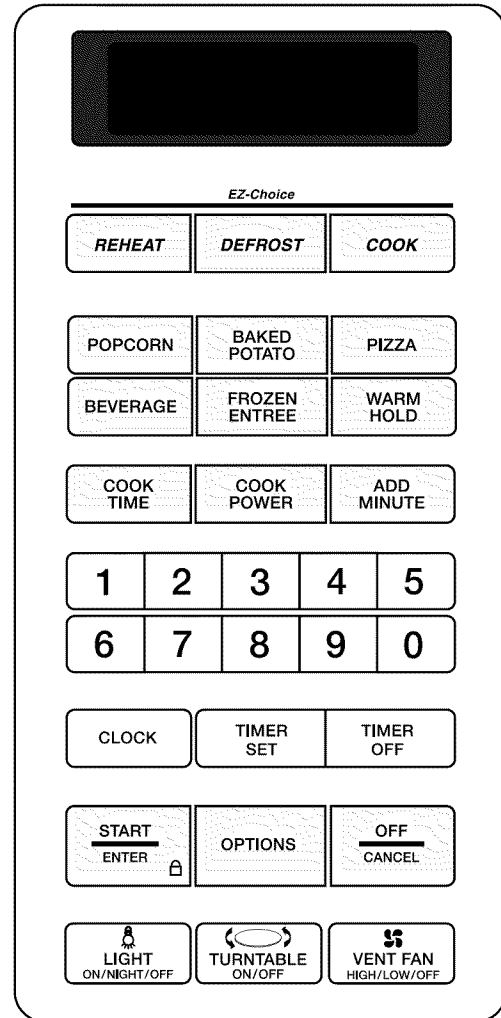

Display

When power is first supplied to the microwave oven, "PLEASE SET TIME OF DAY" scrolls 3 times, and then a ":" will appear on the display.

Any other time the above text scrolls, followed by a ":" on the display, a power failure has occurred. Touch OFF/CANCEL and reset the Clock if needed.

When the microwave oven is in use, the display shows cooking time.

When the microwave oven is not in use, the display shows the time of day or Timer countdown.

Number Codes

The microwave oven is preset with shortcut number codes. A number code includes one or more of the following: cooking power, cook time and food quantity or weight. See the code charts in the "Cooking" and "Reheating" sections for additional information.

Start/Enter

The START/ENTER pad begins any function. If not touched after touching a pad, "TOUCH START" will appear in the display.

If cooking is interrupted, touching START/ENTER will resume the preset cycle.

Off/Cancel

The OFF/CANCEL pad clears any incorrect command and cancels any program during cooking. It will not erase the time of day.

The microwave oven will also turn off when the door is opened. Close the door and touch START/ENTER to resume the cycle.

Clock

This is a 12-hour clock and does not show a.m. or p.m.

To Set:

Before setting, make sure the microwave oven and Timer are off.

1. Touch CLOCK.
 2. Touch the number pads to set the time of day.
 3. Touch CLOCK or START/ENTER.
-

Tones

Tones are audible signals, indicating the following:

One tone

- Valid pad touch (short tone)

Two tones

- End of stage in multi-stage cooking
- Child Lock active (short tones)

Three tones

- Every Minute after end-of cycle tones, as reminder

Four tones

- End-of-cycle

Five Tones

- During DEFROST cycle, reminder to check, turn, rearrange, or separate food

Seven Tones

- End of Timer countdown
-

Timer

The Timer can be set in minutes and seconds, up to 99 minutes 99 seconds, and counts down the set time. The Timer does not start or stop the microwave oven.

When the Timer is in use, the microwave oven can still operate. To see the time countdown for 5 seconds when the microwave oven is in use, touch TIMER SET.

To Set:

1. Touch TIMER SET.
2. Touch the number pads to set the length of time.
3. Touch START/ENTER.
When the set time ends, "End" will appear on the display and 7 tones will sound.
4. Touch TIMER OFF anytime to cancel the Timer.
Remember, touching OFF/CANCEL will turn the microwave oven off.

The time can be reset during the countdown by repeating the above steps.

Child Lock

The Child Lock shuts down the control panel pads to prevent unintended use of the microwave oven.

The Child Lock is preset unlocked, but can be locked.

To Lock/Unlock Control: Before locking, make sure the microwave oven and Timer are off. Touch and hold START/ENTER for 4 seconds until 2 tones sound and "LOCKED" appears on the display. Repeat to unlock and remove "LOCKED" from display.

Vent Fan

The vent fan has 2 speeds: HIGH and LOW.

To protect the microwave oven, if the temperature from the range or cooktop below the microwave oven gets too hot, the vent fan will automatically turn on. It may stay on for up to 1 hour to cool the microwave oven. When this occurs, the VENT FAN HIGH/LOW/OFF pad will not function.

To Turn Vent Fan On/Off: Touch VENT FAN HIGH/LOW/OFF pad once for HIGH, twice for LOW or 3 times for OFF.

Cooktop Light

The cooktop light has 3 options: on, night and off.

To Turn On/Night/Off: Repeatedly touch LIGHT ON/NIGHT/OFF to cycle through options.

Options

Preset values for tones, clock, display scrolling speed and defrost weight may be changed by using the Options function.

To Use: Touch OPTIONS. Then touch the number pad of the function to be changed: 1 for Sound On/Off, 2 for Clock On/Off, 3 for Display Scroll Speed or 4 for Lbs/Kg Choice.

MICROWAVE OVEN USE

A magnetron in the oven produces microwaves which reflect off the metal floor, walls and ceiling and pass through the turntable and appropriate cookware to the food. Microwaves are attracted to and absorbed by fat, sugar and water molecules in the food, causing them to move, producing friction and heat which cooks the food.

- Never lean on or allow children to swing on the oven door.
- Do not operate microwave oven when it is empty.
- Heated liquids can splash out during and after heating. Use of a wooden stir stick placed in the cup or bowl during heating may help to avoid this.
- The turntable must be in place and correct side up when oven is in use. Do not use if turntable is chipped or broken. See "Assistance or Service" section to reorder.
- Baby bottles and baby food jars should not be heated in the oven.
- Clothes, flowers, fruit, herbs, wood, gourds, paper, including brown paper bags and newspaper should not be dried in the oven.
- Do not use the microwave oven for canning, sterilizing or deep frying. The oven cannot maintain appropriate temperatures.
- Paraffin wax will not melt in the oven because it does not absorb microwaves.
- Use oven mitts or pot holders when removing containers from oven.
- Do not overcook potatoes. At the end of the recommended cook time, potatoes should be slightly firm. Let potatoes stand for five minutes. They will finish cooking while standing.
- Do not cook or reheat whole eggs or eggs inside the shell. Steam buildup in whole eggs may cause them to burst. Cover poached eggs and allow a standing time.

Food Characteristics

When microwave cooking, the amount, size and shape, starting temperature, composition and density of the food affect cooking results.

Amount of Food

The more food heated at once the longer the cook time. Check for doneness and add small increments of time if necessary.

Size and Shape

Smaller pieces of food will cook more quickly than larger pieces and uniformly shaped foods cook more evenly than irregularly shaped food.

Starting Temperature

Room temperature foods will heat faster than refrigerated foods and refrigerated foods will heat faster than frozen foods.

Composition and Density

Foods high in fat and sugar will reach a higher temperature and heat faster than other foods. Heavy, dense foods, such as meat and potatoes, require a longer cook time than the same size of a light, porous food, such as cake.

Cooking Guidelines

Covering

Covering food helps retain moisture, shorten cook time and reduce spattering. Use the lid supplied with cookware. If lid is not available, wax paper, paper towels or plastic wrap approved for microwaves may be used. Plastic wrap should be turned back at one corner to provide an opening to vent steam.

Stirring and Turning

Stirring and turning redistributes heat evenly to avoid overcooking the outer edges of food. Stir from outside to center. If possible, turn food over from bottom to top.

Arranging

If heating irregularly shaped or different sized foods, the thinner parts and smaller sizes should be arranged toward the center. If cooking several items of the same size and shape, place them in a ring pattern, leaving the center of the ring empty.

Piercing

Before heating, use a fork or small knife to pierce or prick foods that have a skin or membrane, such as potatoes, egg yolks, chicken livers, hot dogs, and sausage. Prick in several places to allow steam to vent.

Shielding

Use small, flat pieces of aluminum foil to shield the thin pieces of irregularly shaped foods, bones and foods such as chicken wings, leg tips and fish tail. See "Aluminum Foil and Metal" first.

Standing Time

Food will continue to cook by the natural conduction of heat even after the microwave cycle ends. The length of standing time depends on the volume and density of the food.

Cookware and Dinnerware

Cookware and dinnerware must fit on the turntable. Always use oven mitts or pot holders when handling because any dish may become hot from heat transferred from the food. Do not use cookware and dinnerware with gold or silver trim. Use the following chart as a guide, then test before using.

MATERIAL	RECOMMENDATIONS
Aluminum Foil, Metal	See "Aluminum Foil and Metal" section.
Browning Dish	Bottom must be at least $\frac{3}{16}$ in. (5 mm) above the turntable. Follow manufacturer's recommendations.

MATERIAL	RECOMMENDATIONS
Ceramic Glass, Glass	Acceptable for use.
China, Earthenware	Follow manufacturer's recommendations.
Melamine	Follow manufacturer's recommendations.
Paper Towels, Dinnerware, Napkins	Use non-recycled and those approved by the manufacturer for microwave oven use.
Plastic Wraps, Bags, Covers, Dinnerware, Containers	Use those approved by the manufacturer for microwave oven use.
Pottery and Clay	Follow manufacturer's recommendations.
Styrofoam®	Do not use in oven.
Straw, Wicker, Wooden Containers	Do not use in oven.
Wax Paper	Acceptable for use.

To Test Cookware or Dinnerware for Microwave Use:

- Put cookware or dinnerware in oven with 1 cup (250 mL) of water beside it.
- Cook at 100% cooking power for 1 minute.

Do not use cookware or dinnerware if it becomes hot and the water stays cool.

Aluminum Foil and Metal

Always use oven mitts or pot holders when removing dishes from the microwave oven.

Aluminum foil and some metal can be used in the oven. If not used properly, arcing (a blue flash of light) can occur and cause damage to the oven.

OK for Use

Racks and bakeware supplied with the oven, aluminum foil for shielding, and approved meat thermometers may be used with the following guidelines:

- Never allow aluminum foil or metal to touch the inside cavity walls, ceiling or floor.
- Always use the turntable.
- Never allow contact with another metal object during cooking.

Do Not Use

Metal cookware and bakeware, gold, silver, pewter, non-approved meat thermometers, skewers, twist ties, foil liners such as sandwich wrappers, staples and objects with gold or silver trim or a metallic glaze should not be used in the oven.

Cooking Power

Many recipes for microwave cooking specify which cooking power to use by percent, name or number. For example, 70%=7=Medium-High.

Use the following chart as a general guide for the suggested cooking power of specific foods.

PERCENT/ NAME	NUMBER	USE
100%, High (default setting)	10	Quick heating convenience foods and foods with high water content, such as soups, beverages and most vegetables.
90%	9	Cooking small tender pieces of meat, ground meat, poultry pieces and fish fillets. Heating cream soups.
80%	8	Heating rice, pasta or casseroles. Cooking and heating foods that need a cook power lower than high. For example, whole fish and meat loaf.
70%, Medium-High	7	Reheating a single serving of food.
60%	6	Cooking sensitive foods such as cheese and egg dishes, pudding and custards. Cooking non-stirtable casseroles, such as lasagna.
50%, Medium	5	Cooking ham, whole poultry and pot roasts. Simmering stews.
40%	4	Melting chocolate. Heating bread, rolls and pastries.
30%, Medium-Low, Defrost	3	Defrosting bread, fish, meats, poultry and precooked foods.
20%	2	Softening butter, cheese, and ice cream.
10%, Low	1	Taking chill out of fruit.

To Set a Cooking Power other than 100%:

1. Touch COOK TIME.
2. Touch the number pads to set a length of time to cook.
3. Touch COOK POWER.
4. Touch the number pad from the Cooking Power chart.
5. Touch START/ENTER.

The display will count down the cook time.

When the cycle ends, "End" will appear in the display, 4 end-of-cycle tones will sound, and then reminder tones will sound every minute.

6. Touch OFF/CANCEL or open the door to clear the display and/or stop reminder tones.

Cooking

To Use:

1. Touch COOK TIME.
2. Touch the number pads to set a length of time to cook. "TOUCH START OR POWER" scrolls across display. Touch COOK POWER to set a cooking power other than 100%. Touch the number pad(s) from the Cooking Power chart.
3. Touch START/ENTER. The display will count down the cook time. When the cycle ends, "End" will appear in the display, 4 end-of-cycle tones will sound, and then reminder tones will sound every minute.
4. Touch OFF/CANCEL or open the door to clear the display and/or stop reminder tones.

The cook time and cooking power cannot be changed after touching START/ENTER.

EZ-Choice® Cooking

EZ-Choice® COOK settings have preset cooking times and cook powers for 3 categories.

CODE	FOOD	QUANTITY
1	Fresh Vegetable	1-4 cups
2	Frozen Vegetable	1-4 cups
3	Casserole	1-4 cups

To Use:

1. Touch COOK.
2. Touch number pads from chart to select food type to be cooked.
3. Touch number pads to enter quantity in cups.
4. Touch START/ENTER. The display will count down the cook time. When the cycle ends, "End" will appear in the display, 4 end-of-cycle tones will sound, and then reminder tones will sound every minute.

Preset Cooking

Times and cooking power have been preset for five microwavable foods. Use the following chart as a guide.

PRESET COOKING PAD	NUMBER PAD	INSTRUCTIONS
POPCORN	1 = 1.75 oz 2 = 3.0 oz 3 = 3.5 oz	Pop only commercially packaged microwave popcorn. Pop only one bag at a time. If using microwave popcorn popper, follow manufacturer's instructions.
BAKED POTATO	1 - 4 (No. of potatoes)	Based on 10-13 oz potato Before baking, pierce potato with fork several times. After baking, let stand for 5 minutes.
PIZZA	1 - 3 (No. of 5 oz slices)	Place on paper towel.
FROZEN ENTRÉE	1 = 10 oz 2 = 20 oz	Remove from package. Loosen cover on 3 sides.
BEVERAGE	1 - 2 (8 oz cups)	Do not cover.

To Use:

1. Touch appropriate preset cooking pad (see chart, above).
2. Touch number pads to enter quantity (see chart, above). The display will count down the cook time.

When the cycle ends, "End" will appear in the display, 4 end-of-cycle tones will sound, and then reminder tones will sound every minute.

Add Minute

The Add Minute function allows the addition of cook time in one-minute increments. If the Add Minute pad is touched during cooking, 1 minute of cook time at the current cook power setting and/or in the current cooking stage will be added. If the pad is touched after cooking is over, 1 minute of cook time at 100% cook power will be added. Up to 99 minutes of cook time may be added by touching ADD MINUTE.

Cooking in Stages

The oven can be set to cook at different cooking powers for various lengths of time, up to 4 stages, including defrost and Warm Hold. (Some models allow only 3 stages, including defrost.)

To Cook in Stages:

1. Touch COOK TIME.
2. Touch number pads to enter length of time to cook during the first stage.
3. Touch COOK POWER.
4. Touch the number pad(s) using the Cooking Power chart to set the cooking power for the first cycle.
“P-## TOUCH START” scrolls across the display. (## is the percent of cook power.)
5. Repeat steps 1-4 for the second cycle.
6. Touch START/ENTER.

Two tones will sound between cycles, and then the next cycle will begin counting down.

When the cycle ends, “End” will appear in the display, 4 end-of-cycle tones will sound, and then reminder tones will sound every minute.

7. Touch OFF/CANCEL or open the door to clear the display and/or stop reminder tones.

The cook time and cooking power of the cycling stage cannot be changed after touching START/ENTER without interrupting cooking. Only minutes may be added to current cooking stage by touching ADD MINUTE.

EZ-Choice® Reheating

Times and cooking power have been preset for reheating 4 specific food types. Use the following chart as a guide.

CODE	FOOD	QUANTITY
1	Dinner Plate	1-2 Servings
2	Soup/Sauce	1-4 Cups
3	Casserole	1-4 Cups
4	Roll/Muffin	1-4 Pieces

To Use :

1. Touch REHEAT.
2. Touch number pad from chart to select food type to be reheated.
3. Touch number pads to enter quantity.
4. Touch START/ENTER.

The display will count down the reheat time.

When the cycle ends, “End” will appear in the display, 4 end-of-cycle tones will sound, and then reminder tones will sound every minute.

5. Touch OFF/CANCEL or open the door to clear the display and/or stop reminder tones.

EZ-Choice® Defrosting

The EZ-Choice® Defrost feature's preset programs can be used or the microwave oven can be manually set to defrost.

- Food should be 0°F (-18°C) or colder at defrosting for optimal results. How foods are stored can affect results.
- Unwrap foods and remove lids (from fruit juice) before defrosting.
- Shallow packages will defrost more quickly than deep blocks.
- Separate food pieces as soon as possible during or at the end-of-cycle for more even defrosting.
- Use small pieces of aluminum foil to shield parts of food such as chicken wings, leg tips and fish tails. See “Aluminum Foil and Metal” first.

The EZ-Choice® Defrost system has preset times and cook powers for 3 categories: Meat, Poultry and Fish. It should not be used for food left outside the freezer for more than 20 minutes, or for frozen ready-made food.

To defrost manually, use 30% cook power. Refer to a reliable cookbook for defrosting information.

To Use:

1. Touch DEFROST.
“MEAT TOUCH 1, POULTRY TOUCH 2, FISH TOUCH 3” scrolls across display.
2. Touch the number pad 1 for Meat, 2 for Poultry or 3 for Fish.
“ENTER WEIGHT” scrolls across display.
3. Touch the number pads to enter the weight.
Weight can be set from 0.1 LB to 6.0 LBS.
4. Touch START/ENTER.

The display will count down the defrost time.

During defrosting, 5 tones will sound. These tones indicate it is time to check, turn, rearrange, or separate food. Open door, turn food if necessary, close door, and touch START/ENTER to resume defrosting.

When the cycle ends, “End” will appear in the display, 4 end-of-cycle tones will sound, and then reminder tones will sound every minute.

5. Touch OFF/CANCEL or open the door to clear the display and/or stop reminder tones.

Warm Hold (on some models)

⚠ WARNING

Food Poisoning Hazard

Do not let food sit in oven more than one hour before or after cooking.

Doing so can result in food poisoning or sickness.

Hot cooked food can be kept warm in the microwave oven. Warm Hold can be used by itself or can be programmed to follow a cooking cycle. Opening the door during Warm Hold will cancel the function.

To Use:

Put hot cooked food in the oven. Cover plates of food and foods that were cooked covered. Pastries, pies, turnovers, etc. should remain uncovered.

1. Touch WARM HOLD.
“WARM HOLD TOUCH START” scrolls across display.
2. Touch START/ENTER.
When the cycle ends, “End” will appear in the display, 4 end-of-cycle tones will sound, and then reminder tones will sound every minute.
3. Touch OFF/CANCEL or open the door to clear the display and/or stop reminder tones.

To set at end of cycle: Touch WARM HOLD while setting a manual cooking cycle before touching START/ENTER, or during cooking.

MICROWAVE OVEN CARE

General Cleaning

IMPORTANT: Before cleaning, make sure all controls are off and the oven is cool. Always follow label instructions on cleaning products.

Soap, water and a soft cloth or sponge are suggested first unless otherwise noted.

GREASE FILTERS

Do not operate the microwave oven without the grease filters in place.

Soak grease filters in hot water and mild detergent. Scrub and swish to remove embedded dirt. Rinse well and shake dry.

- Do not use ammonia or oven cleaner.
- Do not place in dishwasher.

OVEN CAVITY

Do not use soap-filled scouring pads, abrasive cleaners, steel-wool pads, gritty washcloths or some paper towels. Damage may occur.

The area where the oven door and frame touch when closed should be kept clean.

Average soil

- Mild, non-abrasive soaps and detergents:
Rinse with clean water and dry with soft, lint-free cloth.

Heavy soil

- Mild, non-abrasive soaps and detergents:
Heat 1 cup (250 mL) of water for 2 to 5 minutes in oven. Steam will soften soil. Rinse with clean water and dry with soft, lint-free cloth.

Odors

- Lemon juice or vinegar:
Heat 1 cup (250 mL) of water with 1 tablespoon (15 mL) of either lemon juice or vinegar for 2 to 5 minutes in oven.

OVEN DOOR EXTERIOR

- Glass cleaner and paper towels or non-abrasive plastic scrubbing pad:
Apply glass cleaner to soft cloth or sponge, not directly on panel.

TURNTABLE

Do not operate the microwave oven without the turntable in place.

- Mild cleanser and scouring pad
- Dishwasher

Replacing Filters

The grease filters should be removed and cleaned at least once a month. The charcoal filter cannot be washed and should be replaced every 6 to 12 months. Do not operate the microwave oven without the filters in place. See "Assistance or Service" to reorder filters. See "General Cleaning" for cleaning instructions.

To Remove:

1. Unplug microwave oven or disconnect power.
2. Remove the grease filters by sliding to the back. Pull tab down until the filter drops out.

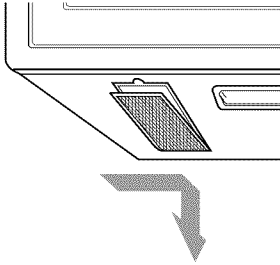

3. Remove charcoal filter by removing the vent grille mounting screws, tipping the grille forward and lifting out to remove. Open the microwave oven door. Then press the tab and lift the front of the filter up, and slide filter straight out.

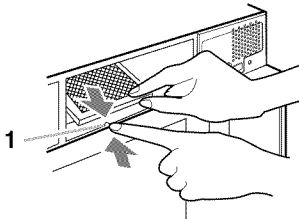

1. Tab

To Replace:

1. Replace charcoal filter by sliding the new filter into place until it rests at an inclined angle. Replace vent grille and mounting screws.
2. Replace grease filters by inserting one end into the frame. Swing other side up and slide into position.
3. Plug in microwave oven or reconnect power.

Replacing Cooktop Light

The cooktop light is a candelabra base 30-watt bulb. See "Assistance or Service" section to reorder.

To Replace:

1. Unplug microwave oven or disconnect power.
2. Remove the bulb cover mounting screws.

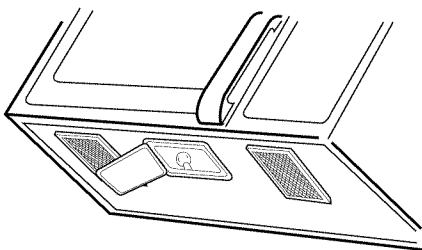

3. Replace light. Close bulb cover. Replace mounting screws.
4. Plug in microwave oven or reconnect power.

Replacing Microwave Oven Light

The microwave oven light is a candelabra base 30-watt bulb. It will automatically come on when the door is opened and when the microwave oven is operating. See "Assistance or Service" section to reorder.

To Replace:

1. Unplug microwave or disconnect power.
2. Remove the 2 outer vent grille mounting screws located above the cover.

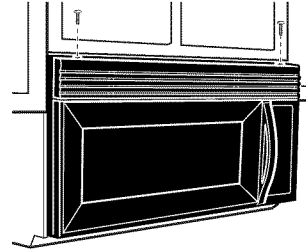

3. Tip the grille forward, then lift out to remove.

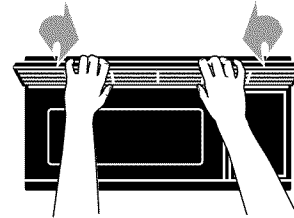

4. Lift up the bulb cover.

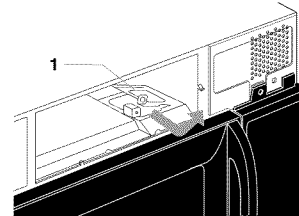

1. Bulb cover

5. Replace light. Close bulb cover.
6. Slide the top of the vent grille into place. Push the bottom until it snaps into place. Replace the mounting screws.

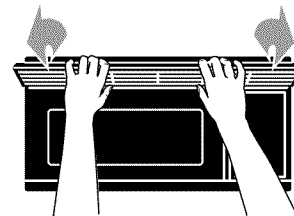

7. Plug in microwave oven or reconnect power.

TROUBLESHOOTING

Try the solutions suggested here first in order to avoid the cost of an unnecessary service call.

Nothing will operate

- **Has a household fuse been blown or has the circuit breaker been tripped?**
Replace the fuse or reset the circuit.
 - **Is the appliance wired properly?**
See Installation Instructions provided with your microwave oven.
-

Oven will not operate

- **Is the door completely closed?**
Firmly close door.
 - **Is the electronic oven control set correctly?**
See "Microwave Oven Control" section.
 - **On some models, is the Child Lock set?**
See "Child Lock" section.
 - **Is the magnetron working properly?**
Heat 1 cup (250 mL) of cold water for 2 minutes at 100% cooking power. If water does not heat, call for service. See "Assistance or Service" section.
-

Oven makes humming noise

- This is normal and occurs when the transformer in the magnetron cycles on.
-

Oven door looks wavy

- This is normal and will not affect performance.
-

Turntable will not operate

- **Is the turntable properly in place?**
Make sure turntable is correct-side up and is sitting securely on the turntable support.
 - **Is the turntable support operating properly?**
Remove turntable. Remove and replace turntable support. Replace turntable. Put in 1 cup (250 mL) of water, then restart oven. If still not working, call for service. See "Assistance or Service" section. Do not operate the oven without turntable and turntable support working properly.
-

Turntable rotates both directions

- This is normal and depends on motor rotation at beginning of cycle.
-

Display shows messages

- **Is the display showing ":"?**
There has been a power failure or the clock time has been turned off. See "Display" section to clear display. See "Clock" section to reset the clock or to turn it on.
 - **Is the display showing a letter followed by a number?**
See "Display" section to clear. If it reappears, call for service. See "Assistance or Service" section.
-

Display shows time countdown, but is not operating

- **Is the Timer in use?**
See "Timer" section.
-

Steam is coming from the vent grille

- Some steam is normal.
-

Fan running slower than usual

- The oven has been stored in a cold area. The fan will run slower until the oven warms up to normal room temperature.
-

Cooking times seem too long

- **Is the cooking power set properly?**
See "Cooking Power" section.
 - **Are large amounts of food being heated?**
Larger amounts of food need longer cooking times.
 - **Is the incoming voltage less than specified in "Microwave Oven Safety"?**
Have a qualified electrician check the electrical system in the home.
-

Radio or TV Interference

- **Is the microwave oven plugged into the same outlet?**
Try a different outlet.
 - **Is the radio or TV receiver near the microwave oven?**
Move the receiver away from the microwave oven, or adjust the radio or TV antenna.
 - **Are the microwave oven door and sealing surfaces clean?**
Make sure these areas are clean.
-

ASSISTANCE OR SERVICE

Before calling for assistance or service, please check "Troubleshooting." It may save you the cost of a service call. If you still need help, follow the instructions below.

When calling, please know the purchase date and the complete model and serial number of your appliance. This information will help us to better respond to your request.

If you need replacement parts

If you need to order replacement parts, we recommend that you only use FSP® replacement parts. FSP® replacement parts will fit right and work right because they are made with the same precision used to build every new WHIRLPOOL® appliance.

To locate FSP® replacement parts in your area, call our Customer Interaction Center telephone number or your nearest Whirlpool designated service center.

In the U.S.A.

Call the Whirlpool Customer Interaction Center toll free: **1-800-253-1301**.

Our consultants provide assistance with:

- Features and specifications on our full line of appliances.
- Installation information.
- Use and maintenance procedures.
- Accessory and repair parts sales.
- Specialized customer assistance (Spanish speaking, hearing impaired, limited vision, etc.).
- Referrals to local dealers, repair parts distributors, and service companies. Whirlpool designated service technicians are trained to fulfill the product warranty and provide after-warranty service, anywhere in the United States.

To locate the Whirlpool designated service company in your area, you can also look in your telephone directory Yellow Pages.

For further assistance

If you need further assistance, you can write to Whirlpool Corporation with any questions or concerns at:

Whirlpool Brand Home Appliances
Customer Interaction Center
553 Benson Road
Benton Harbor, MI 49022-2692

Please include a daytime phone number in your correspondence.

Replacement Parts

Turntable
Part No. 8172138

Turntable Support and Rollers
Part No. 4359509

Turntable Hub
Part No. 8171863

Grease Filters
Part No. 4358853

Charcoal Filters
Part No. 8183916

Cooktop Light Bulb
Part No. 4358971

Microwave Light Bulb
Part No. 4158344

WHIRLPOOL® MICROWAVE HOOD COMBINATION WARRANTY

ONE-YEAR FULL WARRANTY

For one year from the date of purchase, when this appliance is operated and maintained according to instructions attached to or furnished with the product, Whirlpool Corporation will pay for FSP® replacement parts and repair labor to correct defects in materials or workmanship. Service must be provided by a Whirlpool designated service company.

SECOND THROUGH FIFTH YEAR LIMITED WARRANTY ON MAGNETRON TUBE

In the second through fifth years from the date of purchase, when this appliance is operated and maintained according to instructions attached to or furnished with the product, Whirlpool Corporation will pay for FSP® replacement parts for the microwave magnetron tube if defective in materials or workmanship.

Whirlpool Corporation will not pay for:

1. Service calls to correct the installation of your appliance, to instruct you how to use your appliance, to replace house fuses or correct house wiring, or to replace owner-accessible light bulbs and filters.
 2. Repairs when your appliance is used in other than normal, single-family household use.
 3. Pickup and delivery. Your appliance is designed to be repaired in the home.
 4. Damage resulting from accident, alteration, misuse, abuse, fire, flood, improper installation, acts of God or use of products not approved by Whirlpool Corporation.
 5. Repairs to parts or systems resulting from unauthorized modifications made to the appliance.
 6. Replacement parts or repair labor costs for units operated outside the United States.
 7. Any labor costs during the limited warranty period.
-

WHIRLPOOL CORPORATION SHALL NOT BE LIABLE FOR INCIDENTAL OR CONSEQUENTIAL DAMAGES.

Some states do not allow the exclusion or limitation of incidental or consequential damages, so this exclusion or limitation may not apply to you. This warranty gives you specific legal rights and you may also have other rights which may vary from state to state.

Outside the 50 United States, this warranty does not apply. Contact your authorized Whirlpool dealer to determine if another warranty applies.

If you need service, first see the "Troubleshooting" section of this book. After checking "Troubleshooting," additional help can be found by checking the "Assistance or Service" section or by calling the Whirlpool Customer Interaction Center, **1-800-253-1301** (toll-free), from anywhere in the U.S.A.

5/00

Keep this book and your sales slip together for future reference. You must provide proof of purchase or installation date for in-warranty service.

Write down the following information about your appliance to better help you obtain assistance or service if you ever need it. You will need to know your complete model number and serial number. You can find this information on the model and serial number label/plate, located on your appliance as shown in the "Parts and Features" section.

Dealer name _____

Address _____

Phone number _____

Model number _____

Serial number _____

Purchase date _____

8184817/3828W5A2777

© 2002 Whirlpool Corporation.
All rights reserved.

® Registered Trademark/TM Trademark of Whirlpool, U.S.A., Whirlpool Canada Inc. licensee in Canada
® Styrofoam is a Registered Trademark of The Dow Chemical Company.



6/02
Printed in U.S.A.