

Installation instructions and User guide

AeroSmart clothes dryer

US CA (EN)

WARNING: For your safety the information in this manual must be followed to minimize the risk of fire or explosion or to prevent property damage, personal injury or death.

—Do not store or use gasoline or other flammable vapors and liquids in the vicinity of this or any other appliance.

—WHAT TO DO IF YOU SMELL GAS

- Do not try to light any appliance.
- Do not touch any electrical switch; do not use any phone in your building.
- Clear the room, building or area of all occupants.
- Immediately call your gas supplier from a neighbor's phone. Follow the gas supplier's instructions.
- If you cannot reach your gas supplier, call the fire department.

—Installation and service must be performed by a qualified installer, service agency or the gas supplier.

The Governor of California is required to publish a list of substances known to the state of California to cause cancer or reproductive harm and requires business to warn customers of potential exposures to such substances.

WARNING!: Gas appliances contain or produce substances, which can cause death, or serious illness and which are known to the State of California to cause cancer, birth defects, or other reproductive harm. To reduce the risk from substances in fuel or from fuel combustion, make sure this appliance is installed, operated, and maintained according to the manufacturers instructions.

Introduction	2	
Important safety instructions	3	
Installation instructions	7	
The first time you turn your dryer on	32	
Getting started quickly	34	
Operating instructions	34	
AeroSmart controls	36	
Easy touch controls, The display screen	36	
Using your dryer	37	
Sorting and loading	37	
Lint bucket	38	
Choosing your drying cycle	39	
Changing the drying cycle options	40	
Drying cycle options	41	
Drying cycle progress	42	
Drying cycles explained	43	
Lifestyle cycles	46	
Special Care	Handwash / Jeans / Freshen Up / Warm Up / Dryclean	47
Family	Comforter / Pillows / Allergy / Shirts / Towels / Soft Toys	48
Sports	Sportswear Light / Sportswear Heavy / Outdoor Wear / Protection Equipment	50
Care labels	51	
Lid Lock	52	
Power failure	52	
Settings Menu	53	
Alarm Level / Screen Brightness / Key Lock Mode	53	
Reminders / Hints / Language	54	
Service Contacts / Trouble Shooting / Reset Defaults / Replay Intro	55	
Caring for your AeroSmart dryer	56	
Before you call for service	57	
If your AeroSmart dryer beeps for help	57	
Solving operating problems	58	
Solving drying problems	59	
Limited warranty	60	

Important!

SAVE THESE INSTRUCTIONS

The models shown in this User Guide may not be available in all markets and are subject to change at any time. For current details about model and specification availability in your country, please visit our local website listed on the back cover or contact your local Fisher & Paykel dealer.

2 Introduction

Welcome to AeroSmart

Thank you for buying a Fisher & Paykel AeroSmart clothes dryer. We are very proud of this dryer and trust it will serve you well for many years.

At Fisher & Paykel we aim to provide innovative products that are simple to use, ergonomic and kind to the environment.

We have developed this dryer to treat your clothes with the utmost care, drying them gently, so they will look better for longer. We trust you'll enjoy the benefits of its easy loading drum, reverse tumbling and unique lint removal system.

Please take the time to read this User Guide carefully. It will help you to operate and maintain your new AeroSmart dryer.

Your safety, and the safety of others is very important. Located on your dryer and throughout this guide are safety messages and instructions; it is important that you understand and follow them.

We hope you enjoy your new dryer, we have certainly enjoyed designing it for you.

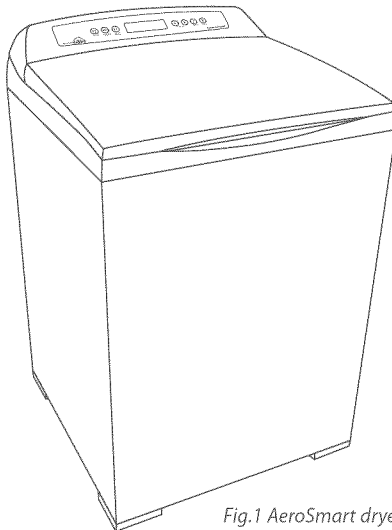

Fig.1 AeroSmart dryer

Important!

It is important that this User Guide should be retained with your AeroSmart clothes dryer for future reference. Should the appliance be sold or transferred to another owner, please ensure that the User Guide is left with the appliance. This will ensure that the new owner can familiarise themselves with the information and warnings contained within the Guide.

Symbols

Symbols will be used in this Guide to highlight when extra care is required. Abide by these at all times to ensure you and your family are not harmed while operating your dryer.

It is important to always act with caution and use common sense when operating your dryer. Use only as instructed by the User Guide.



This is the safety alert symbol. This symbol alerts you to hazards that can kill or hurt you and others.

The safety alert symbol and the word DANGER or WARNING will precede all safety messages. These words mean:



You can be killed or seriously injured if you don't immediately follow instructions.



You can be killed or seriously injured if you don't follow instructions.

All safety messages will identify the hazard, tell you how to reduce the chance of injury, and tell you what can happen if the instructions are not followed.

⚠ WARNING!**Electric Shock Hazard**

Follow the safety precautions outlined in this User Guide.

Failure to do so can result in death or electric shock.

Important safety precautions

- *Read all instructions carefully before using this dryer.*
- *Use this dryer only for its intended purpose as described in this User Guide.*
- *To minimize the possibility of electric shock, unplug this dryer from the power supply or disconnect the dryer at the household distribution panel (by removing the fuse or switching off the circuit breaker) before attempting any user maintenance or cleaning.*
- *Installations must be performed by a qualified or licensed contractor, plumber or gasfitter qualified or licensed by the state, province, or region where this appliance is being installed.*
- *This dryer must be properly installed and located in accordance with the Installation Instructions before it is used.*
- *This dryer must be properly grounded to conform with all governing codes and ordinances. Follow details in Installation Instructions.*
- *Do not install or store the dryer where it will be exposed to water or exposed to the weather.*
- *Connect to a properly protected, rated and sized power supply circuit to avoid electrical overload.*
- *Do not repair or replace any part of the appliance or attempt any servicing, unless specifically recommended in the published user repair instructions that you understand and have the skills to carry out.*
- *When disconnecting the dryer, pull by the plug rather than the cord or junction of the cord plug, to avoid damage to the cord or junction of the cord plug.*
- *Make sure the cord is located so that it will not be stepped on, tripped over or otherwise subject to stress or damage.*
- *Do not tamper with the controls or the lid lock.*
- *Note: Pressing the **POWER** button does NOT disconnect the dryer from the power supply, even though the lights are out.*
- *Do not operate this dryer if it is damaged, malfunctioning, partially disassembled or has missing or broken parts, including a damaged cord or plug.*
- *This dryer must be directly connected to an approved fixed electrical outlet. It cannot be plugged into an extension cord.*

⚠ WARNING!

Fire Hazard



Only dry fabrics that have been washed with water.

Do not use heat to dry articles containing foam rubber or similarly textured rubber-like materials. Dry on the Air Dry cycle.

A clothes dryer produces combustible lint and must be exhausted outdoors. Take care to prevent the accumulation of lint around the exhaust opening and in the surrounding area.

Do not use fabric softeners or products to eliminate static unless recommended by the manufacturer of the fabric softener or product.

Failure to follow these instructions can result in death or personal injury.

To reduce the risk of fire in a tumble dryer the following should be observed:

- Do not place items in a tumble dryer that have previously been cleaned in, washed in, soaked in, or spot cleaned with flammable liquids or solids. They are a fire or explosion hazard. Highly flammable substances commonly used in domestic environments include acetone, denatured alcohol, gasoline, kerosene, some brands of spot removers and dry cleaning solvents, turpentine, waxes, wax removers, vegetable oil, fish oil, massage oil, and cooking oil.
- Do not leave hot oil-affected items in a pile or stack. This can prevent heat from escaping and can create a fire hazard. Oil-affected items can ignite spontaneously, especially when exposed to heat sources such as a tumble dryer. The items become warm causing an oxidation reaction in the oil. This oxidation creates heat. If the heat cannot escape the items can become hot enough to catch fire.
- Do not use heat to dry items containing rubber, foam rubber, plastic or similar materials, (such as padded bras, bath mats, rugs, bibs, baby pants, plastic bags, pillows etc), as these materials might melt or burn. Some rubber materials when heated can under certain circumstances produce fire by spontaneous combustion. Dry only on the **AIR DRY** cycle.
- Unless specifically recommended by their manufacturer, do not use fabric softeners or similar products in a tumble dryer.
- Do not store or use gasoline or other flammable gases and liquids near this or any other appliance.
- Keep the area around and underneath your dryer free from the accumulation of combustible materials such as lint, paper, rags, chemicals etc.
- Do not store any items that may burn or melt (such as paper materials, plastics or plastic containers etc) next to the dryer.
- Empty the lint bucket before the lint reaches the top of the transparent section (usually once a week).
- The dryer must be exhausted to the outside. Carefully follow the venting details in the Installation instructions.
- Keep the floor around your dryer clean and dry to reduce the possibility of slipping.
- If your dryer is running and you want to unload or add clothes, press **START/PAUSE** and wait until the machine has unlocked the lid. Do not force it open.

6 Important safety instructions

- Do not reach into the appliance if the drum is moving.
- Close supervision is necessary if this dryer is used by or near children. Do not allow children to play inside, around or with this dryer or any other appliance.
- Never climb on, climb into, or stand on the dryer top, lid or drum.
- Undergarments that contain metal reinforcements should not be placed directly in the dryer. Damage to the dryer can result if the metal reinforcements come loose during drying.
- The interior of the appliance and exhaust duct should be cleaned periodically by qualified service personnel.
- Before the appliance is removed from service or discarded remove the lid and the drum door to the drying compartment.

SAVE THESE INSTRUCTIONS

⚠ WARNING! – Risk of fire

Clothes dryer installation must be performed by a qualified installer.

Install the clothes dryer according to the manufacturer's instructions and local codes.

Do not install a clothes dryer with flexible plastic venting materials. If flexible metal (foil type) duct is installed, it must be of a specific type identified by the appliance manufacturer as suitable for use with clothes dryers. Flexible venting materials are known to collapse, be easily crushed, and trap lint. These conditions will obstruct clothes dryer airflow and increase the risk of fire.

To reduce the risk of severe injury or death, follow all installation instructions.

SAVE THESE INSTRUCTIONS

Read the important safety instructions on pages 3 – 6 before you start installing the dryer.

Check to make sure you have all the tools and parts necessary to correctly install this appliance.

Tools required

- ¼" nut driver or socket wrench
- Phillips screwdriver
- Flat-blade screwdriver
- Adjustable wrench 8" or 10" (200 mm or 250 mm) for gas connections
- Pipe joint compound (pipe dope or tape) for gas pipe connections that is resistant to LP Propane, Butane and Natural Gas (Gas models only)
- Level
- Caulking gun and compound (for installing new exhaust vent)
- Gloves
- Safety glasses
- Knife
- Duct tape

Parts supplied

- 2 feet inserts for front feet.
 - A power supply cord is supplied already connected to the gas dryer (Gas models only)
- Check to make sure all parts have been supplied.

Accessories

- Mobile Home Installation Kit Part No 395488
- Natural Gas to LP Conversion Kit Part No 395489 (Gas models only)
- LP to Natural Gas Conversion Kit Part No 395490 (Gas models only)
- Kit Element 208V Part No 395500 (Electric models only)

Parts needed

If you need to purchase a power supply cord kit or power supply cable, they must meet the requirements outlined on page 21 (power supply). Check with local codes and read electrical, gas and venting requirements before purchasing parts.

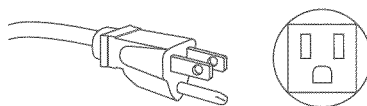

Fig.2 Power supply cord

8 Installation instructions

To the installer

The correct installation of the dryer is your responsibility.

Be sure you read the following instructions carefully before you start to install the dryer. These instructions should be left with the home owner for future reference.

It is your responsibility to:

- Observe all governing codes and ordinances.
- Check code requirements. Some codes limit or do not permit installation of clothes dryers in garages, closets, mobile homes or sleeping quarters. Contact your local building inspector.
- Adhere to these installation instructions.
- Allow for spacing requirements with side by side installations (refer page 9).
- Make sure you have all items necessary for correct installation.
- Properly install the dryer.
- Contact a qualified installer to ensure that the electrical and gas installation meets all national and local codes and ordinances. (See page 4).

Location requirements

⚠ WARNING!



Explosion Hazard

Keep flammable materials and vapors, such as gasoline, away from the dryer.

Place dryer at least 18 inches (460 mm) above the floor for a garage installation.

Failure to do so can result in death, explosion, fire, or burns.

The dryer must be installed or stored in an area which is not exposed to water or weather.

It is extremely important that the dryer is installed in a well ventilated location. This dryer must exhaust air outdoors. Do not install the dryer in any room or closet which does not permit the free flow of replacement air.

The free area of any opening for the introduction of outside air shall not be less than twice the area of the dryer exhaust outlet.

Before installing the dryer ensure that there is sufficient height to fully open the lid. Allow sufficient room behind the dryer for the exhaust. The air intake is at the rear of the dryer. Ensure that there is a sufficient air passage on each side of the dryer for intake air.

Location requirements

The area in which the dryer is located must be kept clear and free from combustible materials, gasoline and other flammable vapors and liquids. A dryer produces combustible lint so the area around the dryer must be cleaned regularly to keep it free of lint.

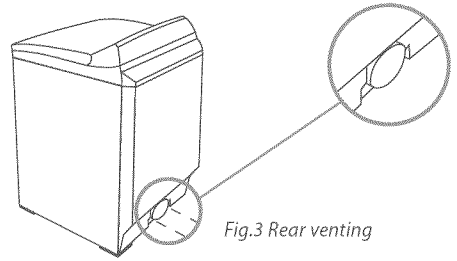

Fig.3 Rear venting

This dryer can only be vented from the rear and must be exhausted to the outdoors.

Alcove or closet installation

⚠ WARNING!

When installing a dryer in a closet/alcove it must be exhausted to the outdoors. No other fuel burning appliance can be installed in the same closet or alcove.

The top opening area in the door must be a minimum of 48 square inches (3100 mm²) and the bottom opening area must have a minimum of 24 square inches (1550 mm²). These openings must never be obstructed (a louvred door with the minimum air opening is acceptable). Minimum installation clearances are required but more clearance is recommended.

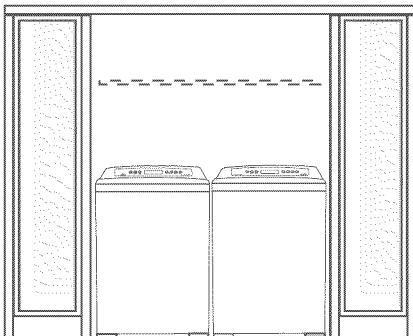

1" (25 mm) 1" (25 mm) 1" (25 mm)

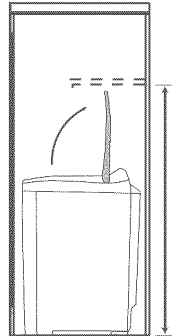

min 56 ⁵/₁₆"
(1430 mm)

Fig.4 Minimum clearances

min 2" (50 mm) min 3" (76 mm)

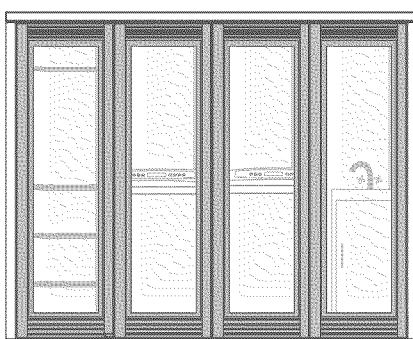

48 sq" (3100 mm²)

total ventilation area
72 sq" (4650 mm²)

24 sq" (1550 mm²)

Fig.5 Minimum ventilation

10 Installation instructions

Dimensions

Check that there is enough clearance for the lid to fully open.

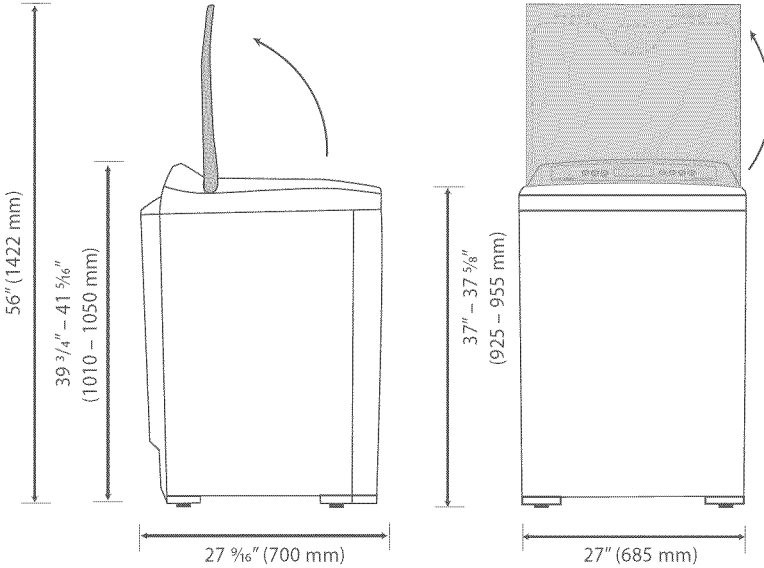

Fig.6 AeroSmart dimensions

Exhaust outlet location

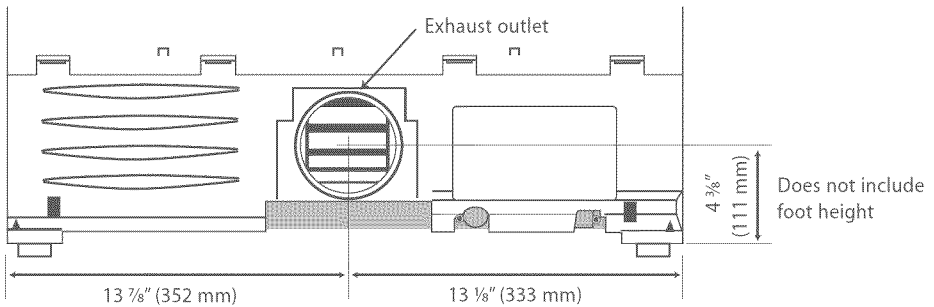

Fig.7 Exhaust outlet dimensions

Mobile home installation

The installation of the dryer in a mobile home must conform to the Manufactured Home Construction and Safety Standard Title 24 CFR, Part 3280 {formerly the Federal Standard for Mobile Home Construction and Safety, Title 24 HUD (Part 280), 1975} for the United States or Standard CAN/CSA – Z240MH for Canada.

When installing a dryer in a mobile home, provisions for anchoring the dryer to the floor must be made.

A Mobile Home anchoring installation kit is available with instructions (see Accessories page 7). Locate in an area that has adequate outside make up air (a minimum of 72 square inches of unobstructed opening is required).

Mobile home installations must be exhausted to the outdoors with the exhaust duct termination securely fastened to the mobile home structure, using materials that will not support combustion.

The exhaust duct must not terminate beneath the mobile home. See the section on exhausting for more information (refer to page 12).

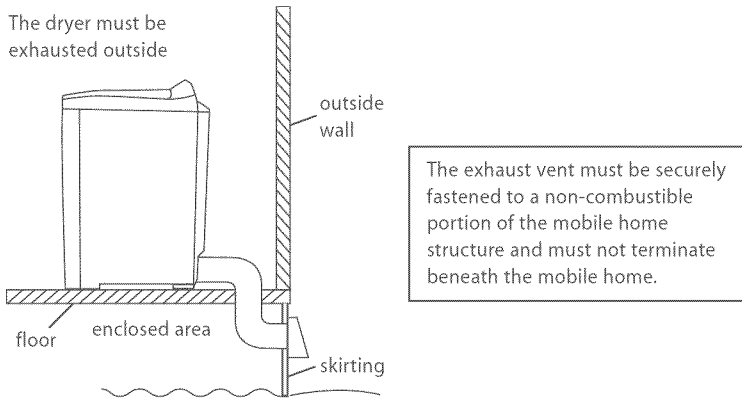

Fig.8 Exterior venting

Venting

⚠ WARNING!**Fire Hazard**

The dryer must be vented to the outdoors.
 Use rigid or thick wall flexible metal exhaust duct only.
 Do not use a plastic exhaust duct.
 Do not use a metal foil exhaust duct.
 Failure to follow these instructions can result in death or fire.

The dryer exhaust must be vented to the outdoors. This will prevent the build up of lint and moisture in the room in which it is located and reduce the risk of fire.

Exhaust ducting products can be purchased from your local Appliance store or Hardware store.

Never use plastic or metal foil flexible duct. This ducting can kink, sag, be punctured, reduce airflow, extend drying times and affect dryer operation.

A minimum of 4 inch (100 mm) thick wall flexible metal or rigid galvanised metal duct must be used. Using ducts larger than 4 inches (100 mm) diameter may result in more lint accumulating. In Canada, the exhaust duct must be 4.02 inches (102 mm) in diameter.

Using straight rigid metal ducting will minimize lint accumulation. Thick wall flexible metal ducting may be used but care must be exercised to avoid sharp bends which may squash the duct and cause blockages.

Use duct tape to secure joints. Do not use screws or any other fastening device which will extend into the duct, as they will collect lint.

Keep ducting as short and straight as possible. Do not exceed the maximum exhaust duct lengths stated later in these installation instructions. The total length of flexible metal duct used should be no longer than 94.5 inches (2.4 m).

Do not vent the dryer into any other duct, chimney or gas vent because accumulated lint and other material is a potential fire hazard. Do not vent the dryer into any ceiling, attic, crawl space, under-floor space, wall cavity, window well or any other concealed cavity that will accumulate lint.

Fit an exhaust hood with a swing-out damper to the outside end of the exhaust duct to prevent back drafts and entry of wild life. Never use exhaust hoods with a magnetic damper. The hood should have at least 12 inches (305 mm) clearance between the bottom of the hood and the ground or other obstruction. The hood opening should point down. Never install a screen over the exhaust outlet.

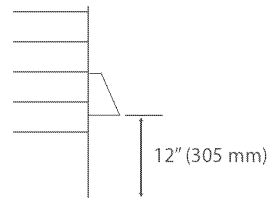

Fig.9 Exhaust hood minimum ground clearance

Venting

To reduce condensation, insulate any ducting which passes through unheated areas. Slope the duct gently downwards to the hood, to drain condensation and reduce lint build up. Avoid sag or loops in the duct as they may collect and store water and accumulate lint.

Before using an existing exhaust duct system for a dryer ensure that:

- No plastic or other potentially combustible duct or flexible metal foil ducting has been used.
- The duct is not pierced, kinked or crushed.
- The duct does not exceed the maximum recommended length for the new dryer.
- The exhaust hood damper opens and closes freely and with sufficient movement.
- Static pressure in the exhaust ducting does not exceed 1 inch of water column (250Pa), or is not less than 0 inches of water column (ie. negative pressure), when measured with a manometer in the 6 inches of the duct nearest the dryer, with the empty dryer running on Air Dry (no heat) setting.
- The exhaust duct system meets all relevant local, state and national codes.

All ducting should be inspected and cleaned at least once a year to remove accumulated lint. Frequently check that the damper on the exhaust hood moves sufficiently and opens and shuts freely.

Mobile Home Installations

A Mobile Home Installation Kit is available (see Accessories page 7).

Determine vent duct length

This dryer can only be vented from the rear and must be exhausted to the outdoors.

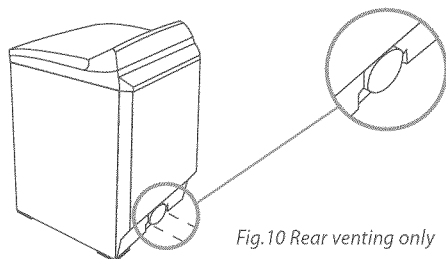

Different types of vent arrangements are shown below.

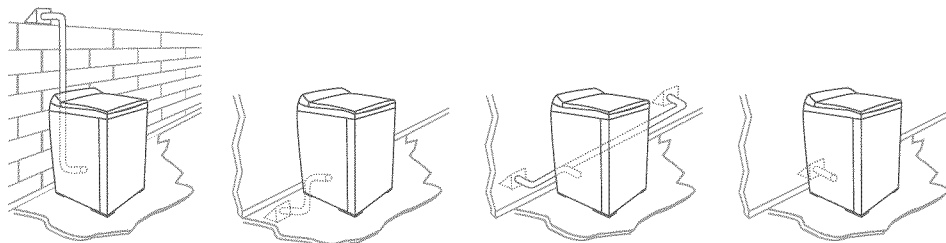

Fig.11 Venting options

14 Installation instructions

Venting

Choose a route that will provide the straightest and most direct path outdoors. Plan the installation to use the fewest number of elbows and turns.

When using elbows (rigid duct) or making turns (thick wall flexible metal duct), allow as much room as possible. With thick wall flexible metal duct bend duct gradually to avoid kinking and avoid 90° turns.

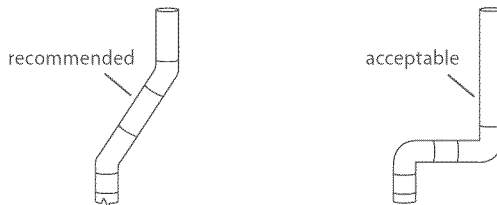

Fig.12 Duct configurations

Maximum length of exhaust duct

The maximum length of the exhaust duct system depends upon:

- The type of ducts (rigid or thick walled flexible metal).
- The number of elbows or bends used.

- 1 Refer to the exhaust duct length chart that matches your hood type for the maximum duct lengths you can use. Do not use duct runs longer than specified in the exhaust duct length charts (refer to page 15).

Exhaust duct systems longer than specified will:

- Accumulate lint creating a potential fire hazard.
- Shorten the life of the dryer.
- Reduce performance, resulting in longer drying times and an increased energy usage.

- 2 Determine the number of elbows/bends you will need.
- 3 In the column listing the type of metal duct you are using (rigid or thick wall flexible metal), find the maximum length of metal duct on the same line as the number of elbows/bends to be used (refer to page 15).

Maximum length of exhaust duct

Preferred 4" Hoods

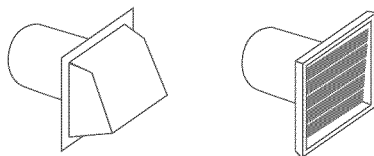

When you have a 4" (100 mm) Hood

Number of 90° elbows/bends	Maximum length of 4" diameter metal duct.			
	Rigid		Thick Wall Flexible Metal (fully extended)	
0	64 ft	19.5 m	8 ft	2.4 m
1	54 ft	16.5 m	8 ft	2.4 m
2	44 ft	13.4 m	8 ft	2.4 m
3	35 ft	10.6 m	8 ft	2.4 m
4	27 ft	8.2 m	8 ft	2.4 m

Acceptable 2 ½" Hood

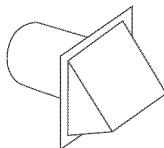

When you have a 2 ½" (60 mm) Hood

Number of 90° elbows/bends	Maximum length of 4" diameter metal duct.			
	Rigid		Thick Wall Flexible Metal (fully extended)	
0	58 ft	17.6 m	8 ft	2.4 m
1	48 ft	14.6 m	8 ft	2.4 m
2	38 ft	11.5 m	8 ft	2.4 m
3	29 ft	8.8 m	8 ft	2.4 m
4	21 ft	6.4 m	8 ft	2.4 m

For exhaust systems not covered by the exhaust duct length charts (such as multiple unit hook-ups, plenums, and power-assist fans), call our Customer Care Center: TOLL FREE 1.888.9.FNP.USA (1.888.936.7872).

16 Installation instructions

Alternative installation for close clearances

Venting systems come in many varieties. Select the type best for your installation. A close-clearance installation is shown.

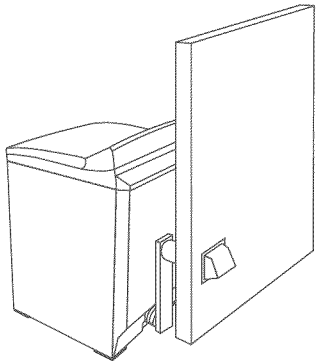

Fig.13 Close-clearance installation

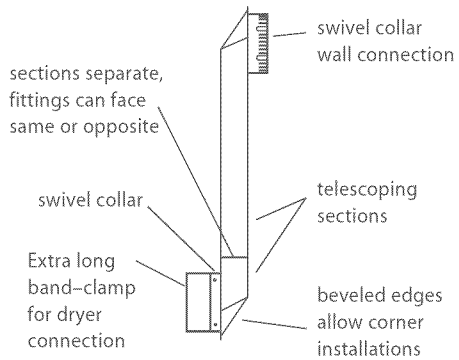

Fig.14 Installation configuration

The maximum length using a 2" x 6" (50 mm x 150 mm) rectangular duct with two elbows and a 2 1/2" (63 mm) exhaust hood is 8 ft (2.4 m).

Refer to the venting system kit manufacturers instructions.

Exhaust venting

⚠ WARNING!



Fire Hazard

- Use heavy metal exhaust duct.
- Do not use a plastic exhaust duct.
- Do not use thin metal foil exhaust duct.
- Failure to do so can result in death or fire.

- 1 Read the exhaust section (pages 12 – 15) before installing the exhaust system to determine the maximum allowable exhaust duct length.

Do not use sheet metal screws when assembling ducting. Always use suitable duct tape. Never use plastic or thin metal foil flexible exhaust material.

- 2 The exhaust outlet is located close to the center of the rear of the dryer. Make sure you join the exhaust duct to the dryer with duct tape only. This will prevent lint and dust from escaping from the dryer and exhaust system.

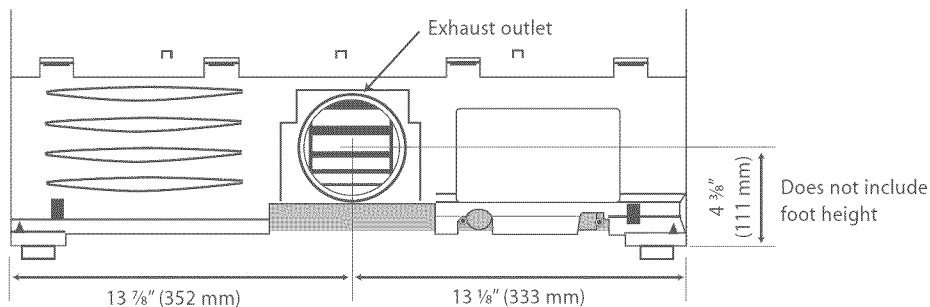

Fig.15 Exhaust venting dimensions

- 3 The exhaust vent can be routed up, down, left, right or straight out the back of the dryer. Refer to diagram.

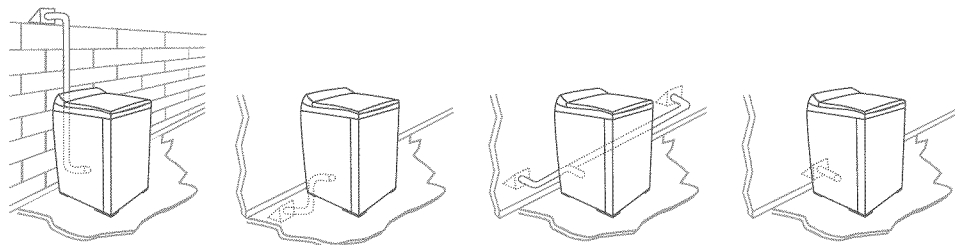

Fig.16 Venting options

Installation

Parts and literature are packaged inside the dryer drum.

⚠ WARNING!



Excess Weight Hazard

Use two or more people to move and install the dryer.
Failure to do so can result in back or other injury.

Only remove the packaging at the customer's premises. This will ensure the appliance arrives in pristine condition and reduces the risk of damage when transporting to the customer's home.

Unpacking

Make sure dryer is in a suitable location for installation.

Consider installing the dryer before the washing machine in a side by side installation, this will allow better access to electrical and exhaust connections.

Remove packaging

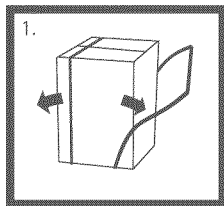

1. Remove straps.

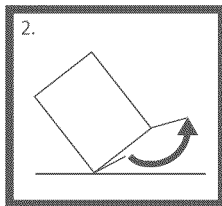

2. Unfold the bottom flaps on the carton.

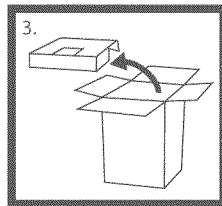

3. Unfold the top flaps on the carton, remove top packer.

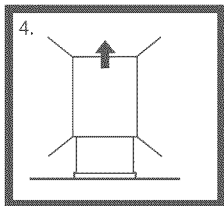

4. Remove the carton by lifting it off the product (do not cut the carton off).

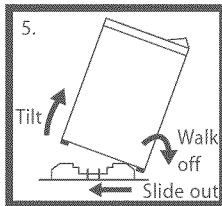

5. Remove the basepacker by tilting the product back and walking the product off it.

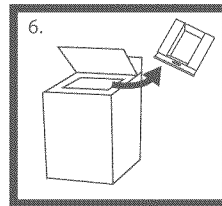

6. Remove the drum packer and the tape from the lint collector bucket in the drum.

Fitting the front feet

Note: Dryer is usually supplied with feet fitted and protruding the correct distance.

- 1 Tilt the dryer back using a hand trolley and making sure the trolley and dryer are secure.
- 2 Fit a rubber insert to each plastic foot as shown.

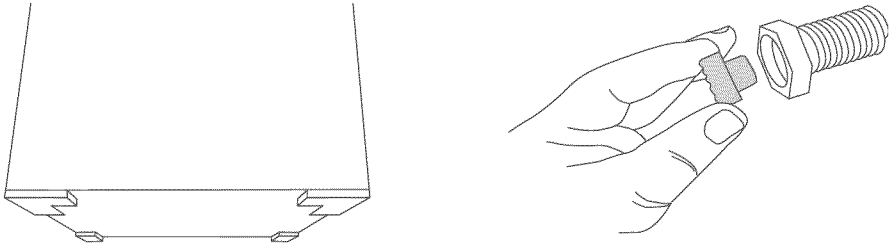

Fig.17 Inserting rubber inserts

- 3 Screw the feet into the foot retainers on the left hand and right hand sides as shown.

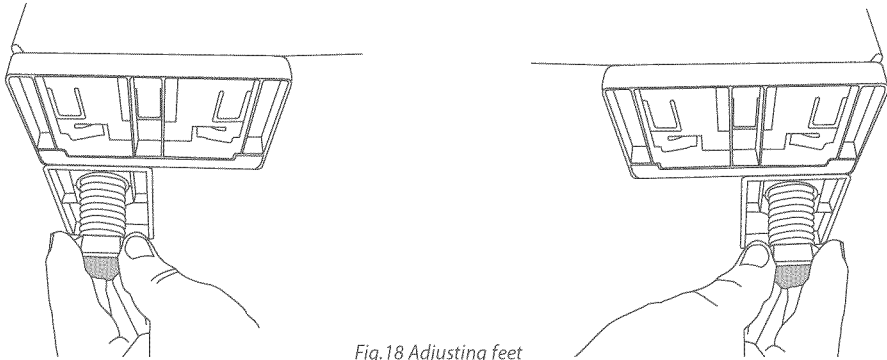

Fig.18 Adjusting feet

- 4 Screw both feet in so they protrude $\frac{1}{2}$ " (12 mm) below the bottom of the wall on the foot retainers.

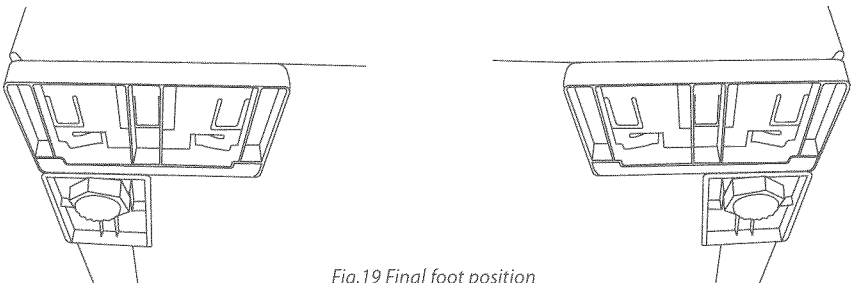

Fig.19 Final foot position

Grounding instructions for gas and electric dryers

⚠ WARNING!**Electrical Shock Hazard**

Make sure appliance is wired or plugged into a grounded outlet.

Do not use an adaptor.

Do not use an extension cord.

Failure to follow these instructions can result in death, fire, or electrical shock.

⚠ WARNING!**Electrical Shock Hazard**

Check with a qualified electrician or serviceperson if you are in doubt as to whether the appliance is properly grounded.

Do not modify the plug if it will not fit the outlet.

Have the proper outlet installed by a qualified electrician.

Failure to follow these instructions can result in death, fire, or electrical shock.

Grounding for a cord-connected appliance

This appliance must be grounded. In the event of malfunction or breakdown, grounding will reduce the risk of electric shock by providing a path of least resistance for electric current. When this appliance is equipped with a cord having an equipment-grounding conductor and a grounding plug, the plug must be plugged into an appropriate outlet that is properly installed and grounded in accordance with all local codes and ordinances, or in their absence, with the National Electrical Code ANSI/NFPA 70, or the Canadian Electrical Code, CSA C22.1. Do not cut or remove the grounding prong from this plug.

**WARNING**

Improper connection of the equipment-grounding conductor can result in a risk of electric shock. Check with a qualified electrician or service representative if you are in doubt as to whether the appliance is properly grounded.

Refer to pages 21 – 27 for wiring details for electric dryers.

Electrical requirements for electric models only

⚠ WARNING!**Electric Shock Hazard**

Use a new UL approved 30-ampere power cord or direct wire cable.

Use a UL approved strain relief.

Disconnect power before making electrical connections.

Connect neutral wire (white or center wire) to center terminal.

On all four wire installations remove the grounding link and connect the ground wire to the green ground connecting screw.

Connect remaining 2 supply wires to remaining 2 terminals.

Securely tighten all electrical connections.

Failure to do so can result in death, fire, or electrical shock.

Note: The wiring diagram is located in the control console.

The dryer must be plugged into or connected to an individual branch circuit, do not use an extension cord.

The power supply must be 220/240V or 208V, 60 Hz approved alternating current electrical service. The electrical service requirements can be found on the data label that is located on the splash back. A 30-ampere fuse or circuit breaker is required on each of the lines.

If a power cord is used, the cord must be plugged into a 30-ampere receptacle.

The power cord is NOT provided with U.S. electric model dryers.

This dryer is supplied with the cabinet grounded through the neutral on the terminal block. If the dryer is to be installed in (1) a new branch circuit installation, (2) a mobile home, (3) a recreational vehicle, (4) an area where local codes do not permit grounding through the neutral conductor, the appliance grounding link must be removed and a 4-wire power cord/cable or a separate grounding wire must be used.

Do not reuse a power supply cord/cable from an old dryer. The power cord/cable electric supply wiring must be retained at the dryer cabinet with a suitable UL listed strain relief.

208V requirements

If your power supply is 208V 60 Hz, a new element kit must be fitted by a qualified electrician or service representative (see Accessories page 7 for kit part number).

22 Installation instructions

Power supply cord requirements for U.S.A (for electric models only)

- Only a UL listed power-supply cord kit a suitable length for the installation and rated 120/240 V min, 30 A and marked with use for clothes dryers shall be used.
- This shall have ring terminals to connect to the dryer.
- The UL-rated strain relief included with it shall be suitable for a 1 1/8" (28.5 mm) hole.

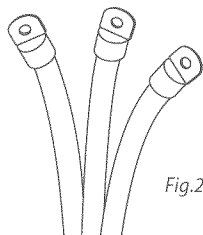
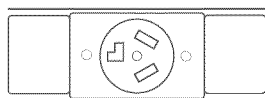
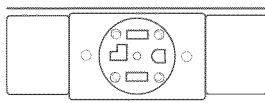

Fig.20 UL listed power-supply cord

If your outlet looks like this



3 wire



4 wire

Choose this power supply cord

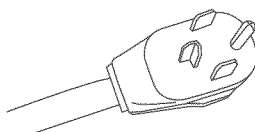
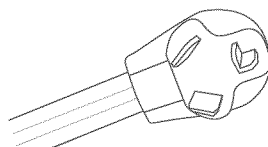

Connecting by direct wire

Power supply cable must match power supply (4-wire or 3-wire) and be:

- Flexible armoured or non-metallic sheathed copper cable (with ground wire). All current-carrying wires must be insulated.
- 10 gauge AWG solid copper wire (do not use aluminium wire).
- Suitable length for the installation.
- A UL approved strain relief must be used.

Grounding for a direct wired appliance

This appliance must be connected to a grounded metal permanent wiring system, or an equipment grounding conductor must be run with the circuit conductors and connected to the equipment-grounding terminal on the appliance.

Electrical connections (electric models only)

Please read **Electrical requirements and grounding instructions on pages 20 – 21 first.** Electric models of the dryer are manufactured for a 3-wire connection system. The dryer frame is grounded by a link to the neutral conductor on the dryer terminal block. If local codes do not permit grounding through the neutral, the grounding link from the terminal block must be removed and a separate ground wire must be used.

The grounding link on the dryer must be removed for all 4-wire installations including new, remodelled construction, or mobile homes.

These Electrical Connection instructions provide for installing the dryer in the following situations:

- 3-wire connection where local codes **permit** grounding through the neutral.
- 3-wire connection plus separate grounding connector where local codes **do not permit** grounding through the neutral.
- 4-wire connection.

Each of the above connections can be made with an approved power supply cord or by direct wiring. Each connection instruction identifies the appropriate Power Supply Cord and covers requirements for direct wiring.

For 3-wire connections by power cords

3-wire power supply cord must have three 10 AWG copper wires and match a 3-wire receptacle of NMEA Type10-30R.

For 3-wire connections by direct wiring

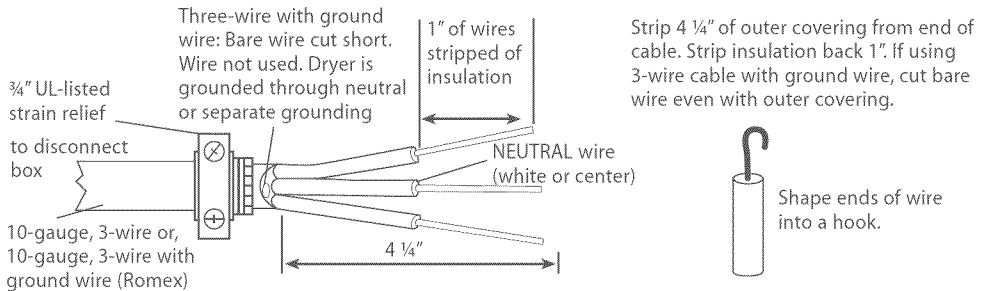

Fig.21 Wiring 3-wire connections

24 Installation instructions

Electrical connections (electric models only)

For 4-wire connections by power cords

4-wire power supply cord must have four 10 AWG copper wires and match a 4-wire receptacle of NMEA Type14-30R. The fourth wire (ground conductor) must be identified by a green cover and the neutral wire by a white cover.

For 4-wire connections by direct wiring

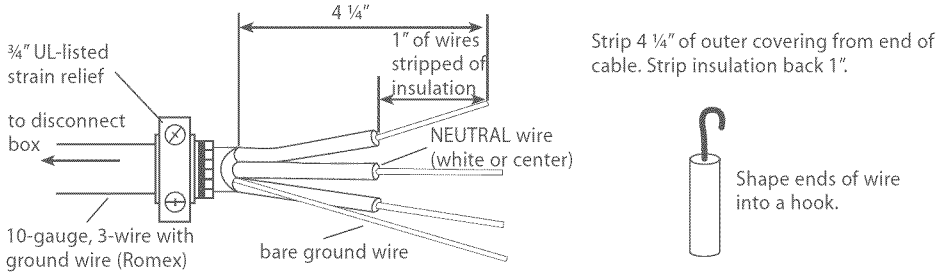

Fig.22 Wiring 4-wire connections

3-wire connections

For use where local codes permit grounding through the Neutral wire.

Use approved 3-wire Power Supply Cord or a 3-wire Cable for Direct Wiring as described on page 23.

- 1 Remove the terminal block cover plate.
- 2 Insert the power cord with a UL listed strain relief through the hole provided in the cabinet near the terminal block. Do not tighten strain relief screw until wiring connections are complete.
Note: a strain relief must be used.

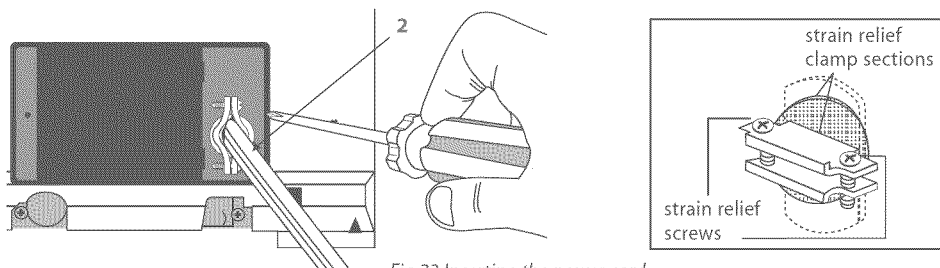

Fig.23 Inserting the power cord

- 3 Loosen or remove the center terminal block screw. Connect the neutral wire (center) of the power supply cord to the center terminal screw of the terminal block. Tighten screw.
- 4 Connect the other wires to the upper and lower terminal block screws marked with the letter L. Tighten screws.

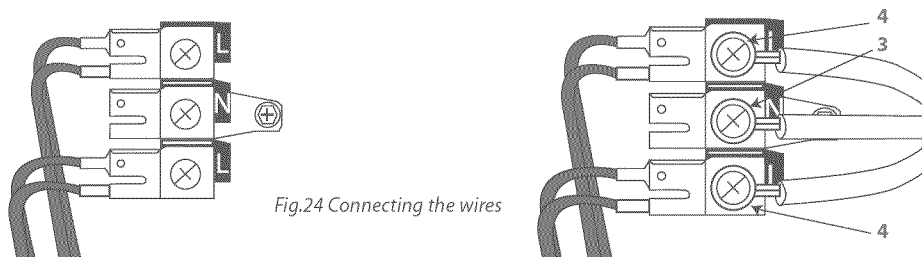

Fig.24 Connecting the wires

- 5 Refit terminal block cover by inserting the two tabs first on the rear panel of the dryer. Secure cover with securing screw.
- 6 Tighten strain relief screws.

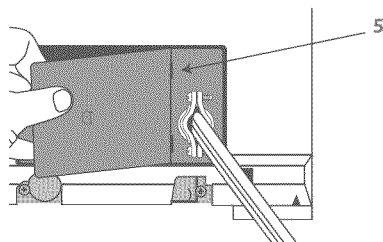

Fig.25 Refitting terminal block cover

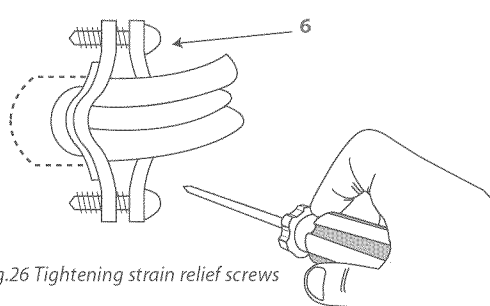

Fig.26 Tightening strain relief screws

3-wire connections plus separate grounding connector

For use where local codes do not permit grounding through the Neutral wire.

Use approved 3-wire Power Supply Cord or a 3-wire Cable for Direct Wiring as described on page 23.

A separate 10AWG copper grounding wire is required.

- 1 Remove the terminal block cover plate.
- 2 Insert the power supply cable with a UL listed strain relief through the hole provided in the cabinet near the terminal block. Do not tighten strain relief screw until wiring connections are complete.

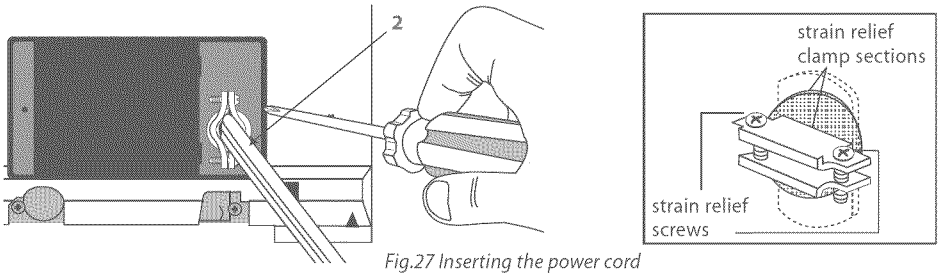

- 3 Remove center terminal block screw.
- 4 Remove appliance ground link by removing the ground connector screw (Green screw).
- 5 Connect a separate copper ground wire (green with yellow stripe) using the ground connector screw (Green screw). Make sure a ring terminal is used when connecting the ground wire and that the wire is firmly secured to an adequate grounding path.

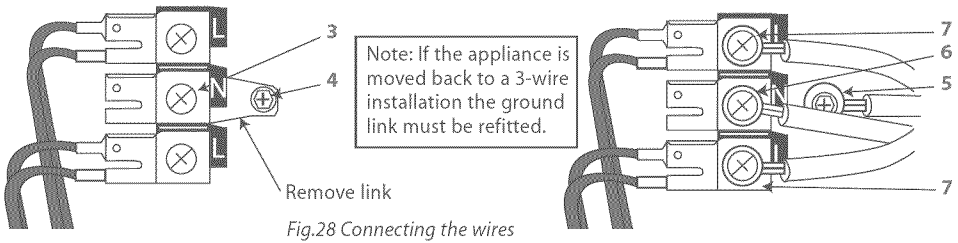

- 6 Connect the neutral wire (center) of the power supply cord to the center terminal screw of the terminal block. Tighten screw.
- 7 Connect the other wires to the upper and lower terminal block screws marked with the letter L. Tighten screws.
- 8 Refit terminal block cover by inserting the two tabs first on the rear panel of the dryer and secure cover with securing screw.
- 9 Tighten strain relief screws.

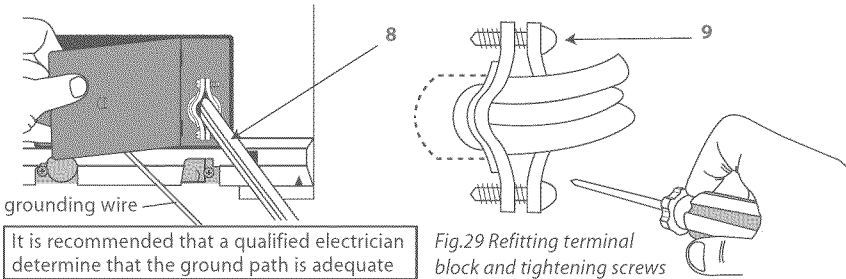

It is recommended that a qualified electrician determine that the ground path is adequate

4-wire connections

Use approved 4-wire Power Supply Cord or a 4-wire Cable for Direct Wiring as described on page 24.

- 1 Remove the terminal block cover plate.
 - 2 Insert the power supply cable with a UL listed strain relief through the hole provided in the cabinet near the terminal block. Do not tighten strain relief screw until wiring connections are complete.
- Note: a strain relief must be used.

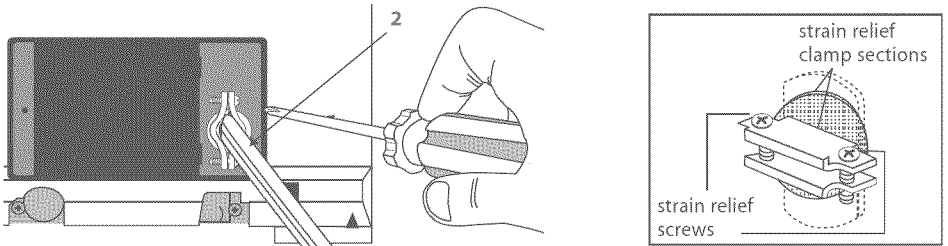

Fig.30 Inserting the power cord

- 3 Remove center terminal block screw.
- 4 Remove appliance ground link by removing the ground connector screw (green screw).

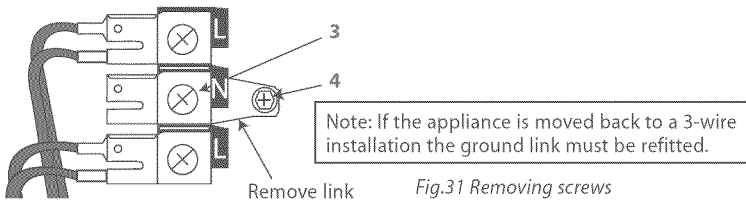

Fig.31 Removing screws

- 5 Connect ground wire (green) of the power supply cord to the ground conductor green screw. Tighten screw.
- 6 Connect the neutral wire (white) of the power supply cord to the center terminal screw of the terminal block. Tighten screw.
- 7 Connect the red wire and black wire to the upper and lower terminal block screws marked with the letter L. Tighten screws.

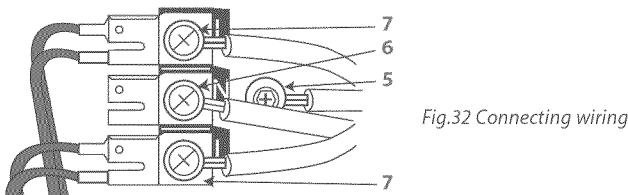

Fig.32 Connecting wiring

- 8 Refit terminal block cover by inserting the two tabs first on the rear panel of the dryer and secure cover with securing screw.
- 9 Tighten Strain Relief screws.

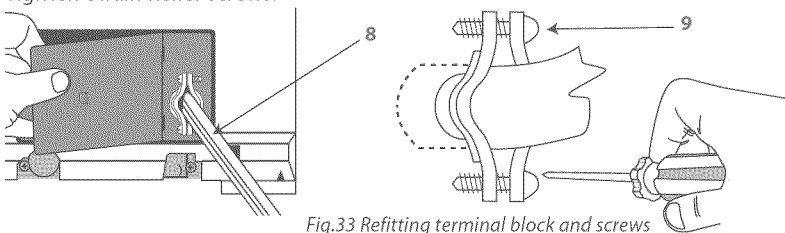



Fig.33 Refitting terminal block and screws

Gas requirements (gas models only)

The installation must conform with Local Codes, or in the absence of Local Codes, to the National Fuel Gas Code ANSI Z223.1/NFPA 54 or the Canadian Natural Gas and Propane Installation Code, CSA B149.1.

⚠ WARNING!

Explosion Hazard



Installations must be performed by a qualified or licensed contractor, plumber, or gasfitter qualified or licensed by the state, province, or region where this appliance is being installed.

Use a new AGA or CSA approved gas supply line.

Install a shut-off valve in an accessible place.

Only use a gas shut-off valve approved for use within the state, province, or region where this appliance is being installed.

Securely tighten all gas connections.

If connecting to LP Gas, have a qualified person make sure gas pressure does not exceed 13" (330 mm) water column.

Failure to follow these instructions can result in death, explosion, or fire.

Gas type

Your dryer must have the correct burner for the type of gas in your home. Burner information is located on the rating plate located on the rear of the console. If this information does not agree with the type of gas available in your home, contact your local Fisher & Paykel supplier or service center.

Natural gas

This dryer is supplied ready for use with Natural Gas.

It is design certified by UL International for LP (Propane or Butane) Gases with the appropriate conversion.

LP gas conversion

If the dryer is to be operated on LP (Liquid Propane or Butane) Gas, the dryer must be converted. To do so, use only the approved Fisher & Paykel conversion kit listed in Accessories on page 7. Do not use with a different gas without consulting the serving gas supplier.

The dryer must be converted for safe and proper performance by qualified service or installation personnel.

Conversion kits for Natural and LP Gas are available from your local Fisher & Paykel Dealer (see Accessories page 7). If other conversions are required, check with your local gas utility for specific information concerning conversion requirements.

Connecting gas to your dryer (gas models only)

Use compound or thread tape appropriate to the gas type that is to be used (Natural or LP Gas), on the male threads of all non-flared connections.

Never use an open flame to test for gas leaks.

This dryer will operate satisfactorily up to altitudes of 6500 ft (2000 m) above sea level at the BTU rating indicated on the model/serial plate. Burner input adjustments may be required if operating above this elevation.

The dryer must be disconnected from the gas supply system during any pressure testing.

Gas ignition

This dryer has an automatic ignition system to ignite the burner. There is no pilot flame burning in this dryer.

Connecting to the gas supply

- 1 The gas supply line should be $\frac{1}{2}$ inch.
- 2 An individual manual shut-off valve must be installed on the gas supply line within 6 ft (1.8 m) of the dryer, in accordance with the National Fuel Gas Code ANSI Z223.1/NFPA 54 for the United States or in accordance with the B149.1 Natural Gas and Propane Installation Code for Canada.
- 3 An $\frac{1}{8}$ inch NPT plugged tapping must be installed to allow the gas inlet pressure to be checked. It must be accessible for the test gauge connection and immediately upstream of the gas connection to the dryer.

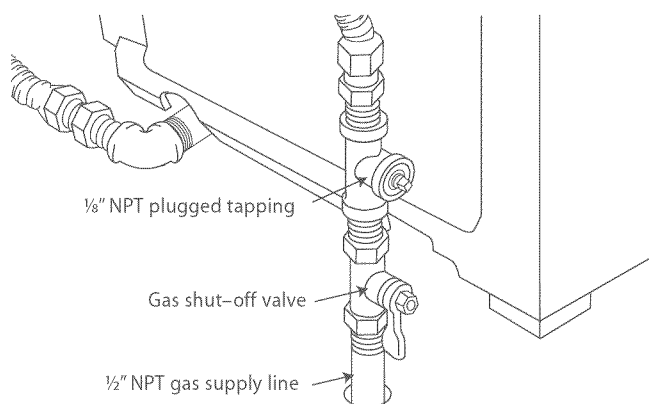

Fig.34 Connecting the gas supply

Connecting gas to your dryer (gas models only)

- 4 A listed connector in compliance with ANSI Z21.24/CSA6.10 must be used to connect the dryer to the gas supply.
- 5 If flexible tubing is used, an elbow should be installed on the pipe at the back of the dryer for the flexible tube to be connected to. This will minimize damage to the tube when the dryer is moved back. Use a flexible tubing connection kit that has designed for use on a clothes dryer. This kit should have the unions necessary to join to the ends of the tubing. Be sure to follow all instructions supplied with the kit.
- 6 Copper tubing should not be used for Natural Gas and if used for LP Gas, it must be LP Gas compatible.
- 7 Disconnect and discard old flexible tubing.
- 8 The gas pipe that comes out of the rear of your dryer has on it a $\frac{3}{8}$ " NPT male thread. Remove the protective cap and apply sealing compound or tape to the thread. Thread sealant should be appropriate for the type of gas to be used.

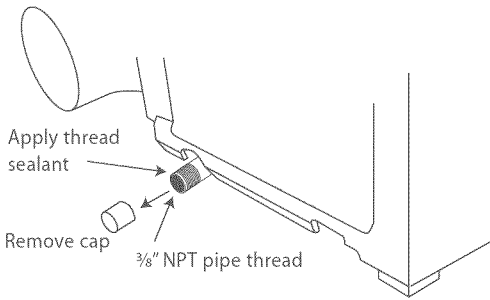

Fig.35 Preparing for gas tubing connection

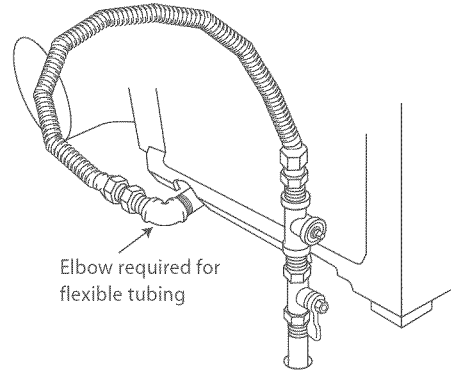

Fig.36 Connecting the gas tubing

Completing the connection

- 9 Use wrenches to tighten all joints but do not over tighten.
- 10 Open the gas supply valve and check all joints by brushing on a non-corrosive leak-detecting solution. Bubbling will indicate a leak. If any leaks are found, close the valve immediately and correct the leaks. Retest and repeat until no leaks are found.

Levelling the dryer

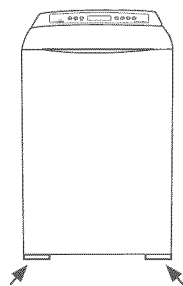

Fig.37 Levelling the dryer

Check the dryer is level, and make necessary adjustments to the front levelling feet. The rear levelling feet are self adjusting.

Final installation check list

Check that:

- No plastic or flexible metal foil is used in the exhaust ducting.
- Exhaust is rigid ducting or thick wall flexible metal ducting.
- All joints in the ducting are made with duct tape. It must not be connected with screws or other fastening devices which extend into the inside of the duct.
- Ducting is clean and is connected to the dryer.
- Inserts are fitted to the two front feet.
- Dryer is level across the front.

Additionally for electric dryer models only, check:

- If installation is 208V, special element kit has been fitted (see page 21).
- Dryer is plugged or directly wired into an approved fitting and is properly grounded.
- Dryer starts, heats, cools and shuts off.
- Customer has been shown how to use the dryer.

Additionally for gas dryer models only, check:

- Dryer is plugged into an approved fitting and is properly grounded.
- All fittings in the gas line are tested for leaks.
- Exhaust temperature increases, to confirm ignition has occurred.
 - If ignition does not occur initially, it may be due to air in the gas line or low voltage power supply.
 - The gas regulator valve may fail to open if the power supply falls below 105 Volts.
 - If the gas fails to flow or does not ignite, the dryer will automatically switch off.
- Customer has been shown how to use the dryer.

Note: All dryers have a drum reversal feature to reduce clothes tangle. Throughout the drying cycle the motor will run for four minutes, then stop and run in the opposite direction for forty seconds before reversing again.

⚠ WARNING!



Electric Shock Hazard

Read and follow the Important safety instructions outlined in this User Guide before operating this appliance, pages 3 – 6.

Failure to do so can result in death, electric shock, fire or injury to persons.

Close supervision is necessary if this dryer is used by or near children. Do not allow children to play inside, around or with this dryer or any other appliance.

Customizing your AeroSmart dryer

The first time that you turn your dryer on an initial set-up mode will be initiated. This is to ensure that your AeroSmart is customized for your individual needs. The set-up mode will prompt you to select the language that you would prefer your AeroSmart dryer to use.

Please select your language preference

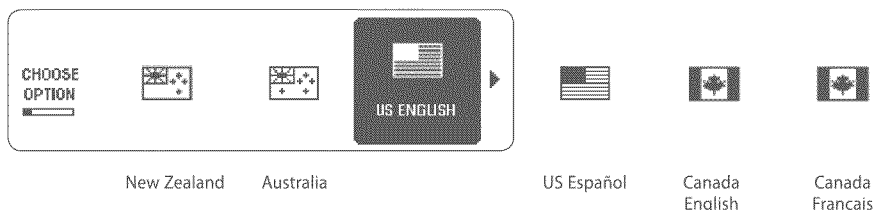

Using the SCROLL buttons, scroll to the language that you would like your dryer to use. Once the language icon has been highlighted, press SELECT to confirm your choice. Your dryer will now use this language, and the initial set-up prompt will not appear again.

If you wish to change your language choice at any time, you can do this by simply selecting the LANGUAGE option in the SETTINGS MENU (please refer to pages 53 and 54).



Smart loading

The new ergonomic design of this dryer means less bending. Simply move clothes from the washer to the dryer with minimal effort.

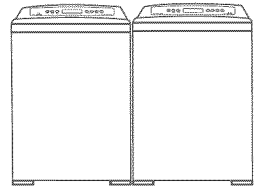

Superior clothes care

Superior clothes care is accomplished by an efficient high airflow fan and careful heat control. The AeroSmart dryer provides the right heat for temperature sensitive delicate articles while still efficiently drying more robust regular and denim loads.

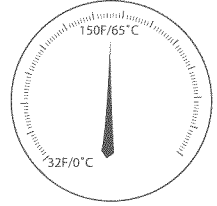

Reverse action tumbling

The drum reverses regularly, so your clothes dry more evenly without roping or tangling.

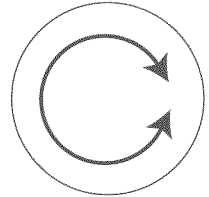

Lint bucket

The lint filter is automatically scraped clean during the drying cycle and the lint is deposited into the lint bucket. No touching or scraping lint any more. Airflow is more efficient as it is never restricted by a blocked filter.

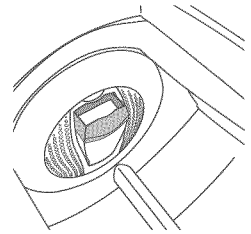

Perfect with the Fisher & Paykel AquaSmart™ washer

The dryer combined with the AquaSmart™ washer's superior spin performance and quick cycle times will cut laundry turn around time by up to one third, reducing the time you spend doing laundry.

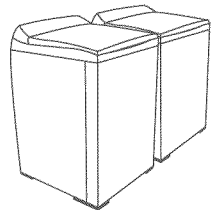

Stainless steel drum

Being stainless steel, this drum is not only more hygienic, it's also more resilient and easier to keep looking good.

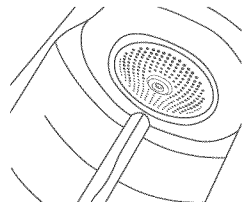

Operating instructions

Sorting

For the best drying results, sort your clothes into similar types that will take a similar time to dry (refer to Sorting page 37).

Loading

Ensure that clothes are loaded no higher than the top of the transparent section of the lint bucket (refer to Loading page 37).

Lint bucket

Before each cycle, check to see if the lint bucket needs to be emptied. Empty the bucket before the lint reaches the top of the transparent section (refer to Lint bucket page 38).

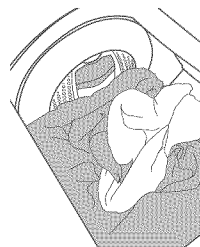
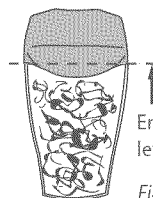

Fig.38 Maximum loading level



Empty before this level is reached

Fig.39 Lint bucket

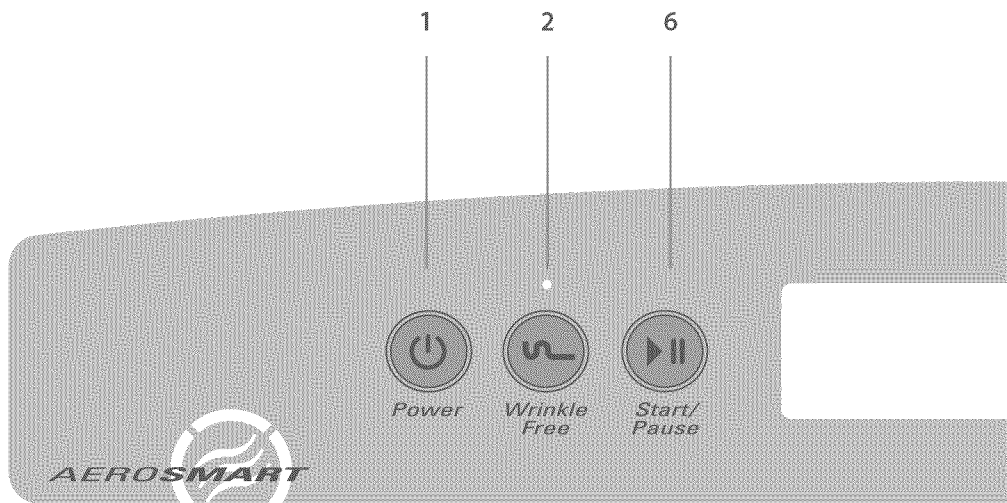

Fig.40 AeroSmart control panel

Easy touch buttons and LCD screen

These buttons require only a gentle touch to activate.

- 1 Touch POWER to activate your AeroSmart dryer.
- 2 WRINKLE FREE – this light tells you when WRINKLE FREE mode is recommended, and the button also allows you to activate the WRINKLE FREE mode manually. (refer to page 36).
- 3 The LCD display screen, located in the middle of the control panel, will display the cycle options available (refer to page 41).
- 4 Use the SCROLL buttons to select the drying cycle that best suits your load (refer to page 41).
- 5 Use the SELECT/TICK button to confirm your selection. (For more information on how to alter the cycle options refer to pages 40 – 41).
- 6 Ensure the lid is closed and touch START - your AeroSmart will automatically lock the lid and close the drum. It will then start to tumble, automatically sensing the dryness of your load as the cycle progresses (unless Timed Dry is selected).

To pause your AeroSmart dryer at any time, simply touch START/PAUSE.

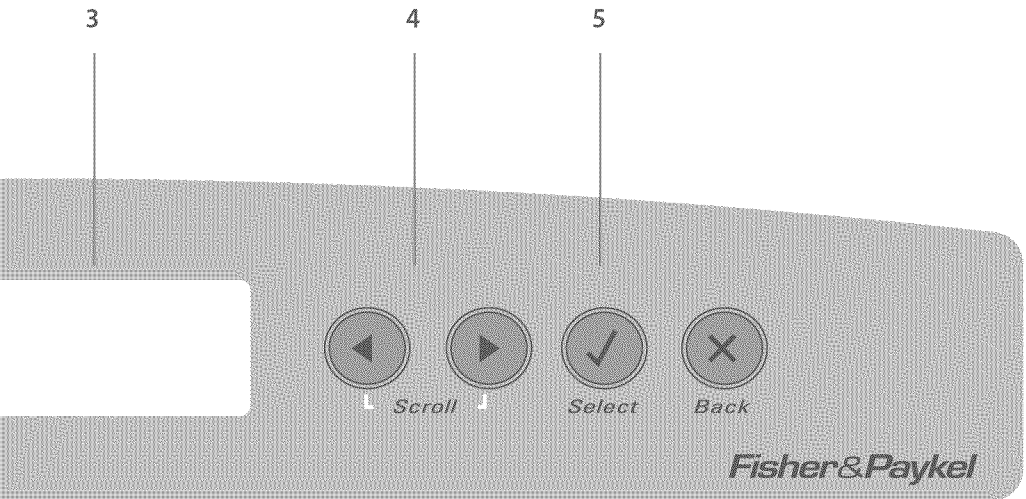



Easy touch controls

These smooth, easy clean buttons require only a gentle touch to activate. To scroll you need to remove your finger to break contact and touch it again. Once you become accustomed to the soft touch technology you will find it effortless to operate.



Wrinkle Free mode

This button activates or deactivates the WRINKLE FREE mode. This mode minimizes the likelihood of wrinkles forming in clothes, if you are not able to unload the dryer straight away. WRINKLE FREE rotates the drum periodically after the cycle has finished. This tumbling action, combined with blowing cool air through the clothes, helps garments to remain wrinkle free.

WRINKLE FREE uses very little power and will continue for up to 24 hours or until the dryer is paused or switched off. WRINKLE FREE can be selected on any cycle.

The WRINKLE FREE symbol  will appear on the screen when the mode is active.



Scroll

The SCROLL buttons allow you to scroll between the drying options.

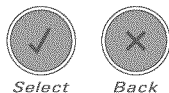

Select

Use the SELECT key to confirm your selected option and the BACK key to cancel.

The display screen

The display screen allows you to view the available cycles and modify options. It provides feedback on what your AeroSmart dryer is doing and how long the cycle has to go, to keep you informed throughout the process. The screen will also display messages to help you with the overall running of your dryer.

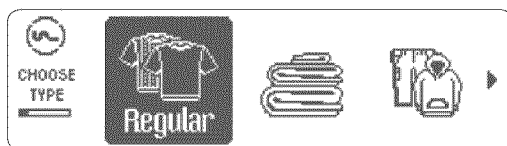

Check the care labels inside the garments to determine whether the garment manufacturer recommends tumble-drying.

Sorting

It is best that you sort your garments before placing them into the dryer. Sort into loads of similar types, and loads that take similar times to dry.

Heavier items (eg towels, t-shirts and flannel sheets) are best dried separately from lightweight items (eg synthetics, poly-cotton sheets and shirts). This prevents the possibility of some items becoming over-dried whilst others are still damp. It will also help to extend the life of your clothing and linen.

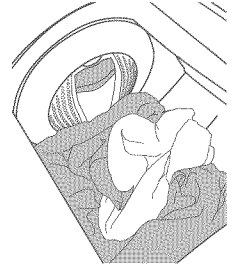

Fig.41 Sort before loading

For best results match your load to the drying cycles offered to ensure the best drying of your items (for more information on drying cycles available refer to page 43).

Drying your clothes as soon as the washer has finished will decrease the chance of wrinkles and the chance of dye transfer from colored items to white items.

We recommend that articles of clothing with screen-printing are turned inside out to ensure the screen-printing does not stick to the drum. Garments with hooks or zippers need to be fastened and where possible turned inside out. Place undergarments in a net bag to provide protection from other items in the load.

Loading

Garments need to be loaded correctly to reduce the likelihood of them wrinkling and to ensure the load is dried evenly. Make sure there is ample room for the garments to tumble freely while drying. Load in terms of the space the garments take up when dry, rather than when they are wet.

The general rule is one wash load = one dryer load.

Only load the dryer up to the top of the transparent section of the lint bucket. Loading any higher may result in uneven drying, tangling, wrinkling and the dryer becoming overloaded.

It is a good idea to dry 'permanent press' type garments together using the EASY IRON cycle, which has the WRINKLE FREE option turned on. This will help reduce wrinkles and the need for ironing.

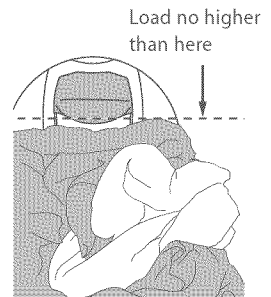

Fig.42 Maximum loading level

Lint bucket

The AeroSmart dryer's lint removal system is unique. Unlike other dryers, the AeroSmart dryer automatically removes the lint for you, from the lint screen – all you have to do is tip the lint out!

The lint filter is hidden behind the lint bucket. As the air passes through this filter the lint is caught on the fine mesh. Once the lint is about $\frac{1}{8}$ " (2 mm) thick it comes into contact with a scraper which deposits it into the bucket. This process is automatically performed every time lint builds up on the filter.

Apart from the benefit of not having to scrape the lint after every cycle, it also means the drying efficiency is not affected by lint build-up during the drying cycle.

The lint bucket is located inside the dryer on the left-hand side. You can remove it by gently pulling the handle and lifting outwards. It slots easily back into place.

This lint bucket does not need to be cleaned as regularly as other dryer's lint filters. The lint bucket only needs to be emptied before the lint reaches the top of the transparent section.

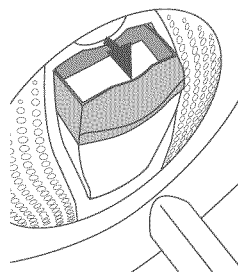

Fig.43 Removing lint bucket

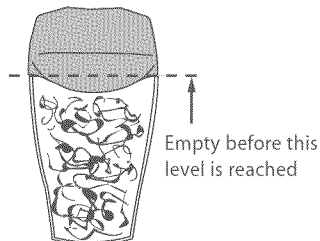

Fig.44 Maximum lint level

Important!

It is important that you run your dryer with the lint bucket in place at all times.

Viewing the drying cycles

- When you turn your AeroSmart dryer on, the main drying cycles will be displayed.

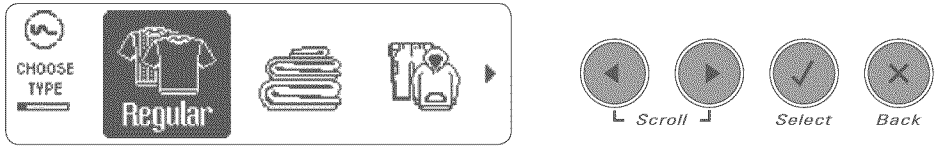

- To view all 8 drying cycles, the Lifestyle cycles and menu options, use the arrow buttons to scroll to the right.

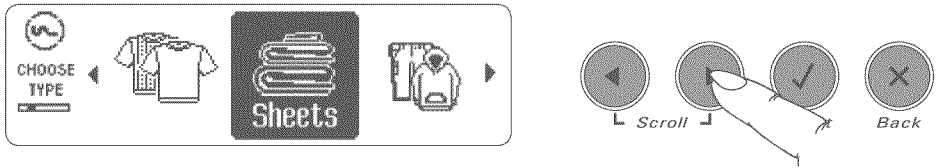

- To see the cycles explained in more detail please refer to pages 43 – 50.

To select a drying cycle

- To select a drying cycle scroll along until your selection is highlighted then touch the SELECT button. This will confirm your selection.

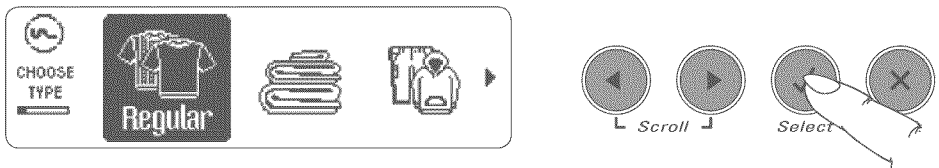

- The drying cycle options will then be displayed for your chosen cycle.

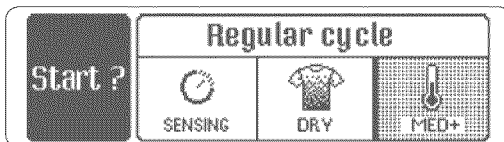

40 Changing the drying cycle options

- 1 Scroll to the option you wish to modify, by highlighting it and touching the SELECT button.

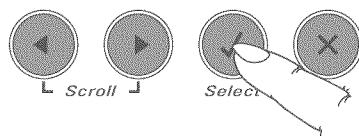

- 2 Scroll to the appropriate setting and press SELECT. This will highlight your choice to show you that it has been selected.

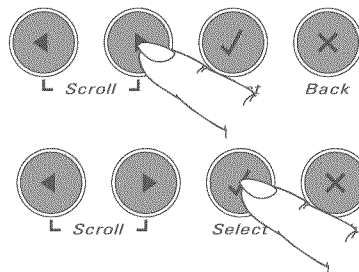
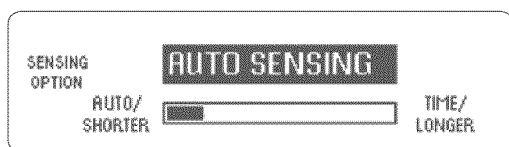

- 3 You will then be given the option to save this modified option for future cycles or to just use it for this one. If you select 'save for future cycles?', the machine will save the changed option for that cycle only.
- 4 Press SELECT to select.
- 5 You will then return to the main cycle options screen.
- 6 Select START to begin drying, or press the START/PAUSE button.

Cycle options

To alter any of the Cycle Options explained below, please refer to page 40 for further instructions.



Auto Sensing

Auto sensing is automatically selected when your AeroSmart dryer is turned on. AeroSmart's internal computer automatically measures the moisture content of the load and will turn off when it senses that the clothes have reached the designated dryness level.

Using the Auto sensing capability of your dryer will ensure the best possible drying result.

Timed Dry

Timed Dry allows you to select from three time periods – 20, 40 and 80 minutes. A cooling period of 10 minutes is also included in the 80 and 40 minute cycles and a 5 minute cool down is included in the 20 minute cycle.

If you choose to select Timed Dry, please note that the dryer will not sense when your clothes are dry. This may increase the chance of over-drying. We recommend that you dry your clothes for a slightly shorter time than you think they need, or check on them regularly (to avoid overdrying).

Auto sensing often provides the best drying results and can lead to lower energy costs when compared to using the Timed Dry option.



Dryness Level (How dry?)

AeroSmart offers 5 dryness levels to choose from. This allows you to customise how dry you would like your load to be at the end of the cycle, when using the Auto sensing option.

Damp Garments are considered 'moist'	Damp+ (Damp/Dry)	Dry Garments are considered 'dry'	Dry+ (Dry/Extra Dry)	Extra Dry Garments are 'extra dry'
Suitable for delicate, light-weight fabrics, and garments which you may wish to iron dry		Designed to provide items dry enough to be worn immediately		Useful for drying items that you wish to store (cupboard dry)

If items are still damp, or too dry at the conclusion of the cycle, next time try adjusting the dryness level to customise it to your personal preference.

42 Changing the drying cycle options



Temperature

AeroSmart offers 4 drying temperatures. Each drying cycle is set with a temperature specific to the load type, to ensure the best possible fabric care for your clothes. If you wish to use a different temperature simply select another drying cycle.

Air no heat	Low gentle heat	Medium moderate heat	High maximum heat
Circulates room temperature air through the drum to dry clothes without heat	This low heat provides extra care for special items	This moderate heat provides efficient drying for garments that require a reduced heat	This setting is the maximum heat setting to dry more robust, everyday items quickly

Remember to always check care labels on garments before placing them into the dryer or selecting a drying temperature.

Drying cycle progress

As the cycle progresses the following symbols will be shown on the display screen to indicate the progression of the cycle and which phase of the process AeroSmart has reached and the dryness level selected. A progress bar will also appear once the cycle has started, to let you know how the drying is progressing. For Time Dry cycles, Time To Go will also be displayed.



sensing dampness

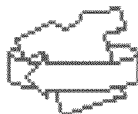

drying



air drying



cooling

Drying cycles explained

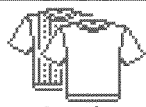

Regular

Regular

A high heat cycle for rapid drying of everyday cottons. This cycle is suitable for most garments labelled "Tumble Dry".

Drying Temp	Medium+
Dryness Level	Dry
Automatic Wrinkle Free	Off



Bed Sheets

Bed Sheets

A high heat cycle, with WRINKLE FREE option, for the optimum result for sheets.

Drying Temp	Medium+
Dryness Level	Dry+
Automatic Wrinkle Free	On



Heavy

Heavy

An extended, high heat cycle for heavy fabrics and denims to ensure thick and bulky seams are thoroughly dried.

Drying Temp	High
Dryness Level	Dry+
Automatic Wrinkle Free	Off



Delicate

Delicate

Extra care for delicate heat sensitive items or fabrics recommending low heat.

Drying Temp	Low
Dryness Level	Dry
Automatic Wrinkle Free	On



Easy Iron







Easy Iron

A medium heat cycle with WRINKLE FREE option, for extra care and to reduce the likelihood of wrinkles forming. Ideal for any garments that you may wish to wear immediately.

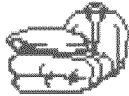
Drying Temp	Medium
Dryness Level	Dry
Automatic Wrinkle Free	On

44 Changing the drying cycle options

Drying cycles explained

 Bulky	Bulky Six specialised drying cycles recommended for drying bulky items to choose from:
 Comforter Feather or Synthetic options	 Pillows Feather or Synthetic options
 Blanket	 Throw
 Jacket	 Sleeping (ZZz) Bag Feather or Synthetic options

For all bulky items:

- It is important that you check the care label of any item carefully, to ensure it is suitable for tumble-drying, before placing it into the dryer.
- Check that the load sits no higher than the top of the lint bucket before you close the lid.

Comforters / Sleeping Bags / Pillows:

It is a good idea to check your comforter throughout the cycle to ensure even drying. Reposition if necessary. If the comforter contains feathers place a heavy item (eg a towel tied in a knot) to help fluff the feathers.



Blankets / Throws:

For best results include 4 – 5 medium sized towels in the dryer with the blanket for cushioning. This will help to reduce shrinkage from over tumbling. When drying more than one blanket, check that there is enough room for them to tumble easily. At the end of the cycle remove the blanket, shake and if necessary stretch the blanket back to its original shape.

Important!

Dry blankets thoroughly to prevent mildew from forming.

Drying cycles explained

	<p>Casual A medium heat cycle ideal for lightweight cottons and items labelled “tumble with a medium heat”.</p>
<p>Casual</p>	
<p>Drying Temp</p>	<p>Medium</p>
<p>Dryness Level</p>	<p>Dry</p>
<p>Automatic Wrinkle Free</p>	<p>Off</p>
	<p>Air Dry A cool cycle for drying items without heat. Perfect for airing clean clothes or to freshen up garments that have been packed in a suitcase or drawer.</p>
<p>Air Dry</p>	
<p>Drying Temp</p>	<p>No heat</p>
<p>Dryness Level</p>	<p>Time Dry</p>
<p>Automatic Wrinkle Free</p>	<p>Off</p>

No experience necessary

Your AeroSmart dryer offers you a range of special Lifestyle cycles, to make drying even easier. These cycles have been specifically designed by our laundry experts, with you in mind. We have incorporated 70 years of laundry knowledge into 18 easy to use, preprogrammed drying cycles. This allows you to let the dryer deal with some of the more tricky drying situations you may encounter, ensuring that you get the same results as a laundry expert, without having to be one.

Lifestyle Cycles

Special Care	Handwash	Jeans	Freshen Up	Warm Up	Dry Clean	
Family	Comforter	Pillows	Allergy	Shirts	Towels	Soft Toys
Sport	Sportswear Light	Sportswear Heavy	Outdoor Wear	Protection Equipment		

To access Lifestyle cycles:

- 1 Scroll though the drying cycles to reach the LIFESTYLE option. 
- 2 Select LIFESTYLE, by touching the SELECT button, to the right of the screen.
- 3 Use the SCROLL buttons to scroll though the three Lifestyle categories.
- 4 Use the SELECT button to select a LIFESTYLE category.
- 5 Scroll through the Lifestyle cycles, touch SELECT to confirm your cycle choice, and then press START.

The Lifestyle cycles are presented in three distinct categories, to help you to access them quickly and easily. The following pages explain the unique cycles that are located within these categories, and how they might be of help.



Special Care

Special care offers 5 unique cycles to provide extra care for your garments.



Handwash

This is an extra gentle cycle for delicate items. Before placing any garments into the dryer please check the care label carefully.

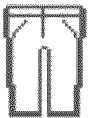

Jeans

The JEANS option has been designed for denims and jeans with thick seams that require additional drying.

Not all jeans require the same type of drying. Some need a more gentle approach to ensure they stay looking great. This is why we have created two unique JEANS options:

WORKWEAR – a long, high heat cycle for sturdy everyday denims with bulky seams.

FASHION – a long, medium heat cycle to care for lightweight fashion jeans and to minimize shrinkage.



Freshen Up

This cycle tumbles for 20 minutes without heat. It has been designed to freshen clean clothes that have been stored in a cupboard, drawer or in a suitcase. It can also be used to remove lint from clothing.



Warm Up

Warm Up heats clothes for 20 minutes so that they are warm to touch. Warm your pyjamas before bed on a cold night or your towels while you are in the shower. This cycle is not recommended for heat sensitive items.

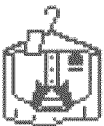

Dry Clean

This cycle has been designed for use with in-dryer dry clean products. It uses a medium heat for 40 minutes and the WRINKLE FREE option is activated. Follow the manufacturer's instructions carefully.

Important!

Ensure that the dry cleaning product is suitable for use in a domestic dryer.



Family

Some common household laundry situations may require extra knowledge. We have created six unique FAMILY cycles to help you with those tricky situations.



Comforter

Bulky items like Comforters can be tricky to dry due to their thickness. The Comforter cycle has been designed to cope with bulky bedding. There are two Comforter types to choose from – Feather or Synthetic.

Important!

It is important that before placing a comforter into the dryer you check the care label to see if it suitable to be tumble dried.

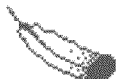

Feather Comforters

This autosensing, low heat cycle is designed to ensure the best results for feather Comforters. Feathers tend to bunch when washed, so we recommend that when drying that you place a heavy item (eg a towel tied in a knot) in with the load to help fluff the feathers up.



Synthetic Comforters

Synthetic Comforters are treated to an auto sensing, low heat cycle designed for lighter, synthetic comforters. Check during cycle and reposition if necessary to ensure even drying.

Important!

Check that the load does not sit higher than the top of the lint bucket before starting the cycle.



Family



Pillows

Choose from either Feather or Synthetic, low heat options to care for your pillows during drying. Check throughout the cycle to ensure even drying. If pillows are not completely dried at the end of the 40 minute period, repeat the Pillows cycle.



Allergy

This cycle has been developed to compliment the Allergy wash in the *AquaSmart™* washer. It is recommended for allergy sufferers, as well as for peace of mind in times of family illness. Allergy uses a high heat to ensure that dust mites and bacteria populations are decimated. It has been designed primarily for sheets and everyday clothing, and is not recommended for garments that are heat sensitive.



Shirts

This medium heat, autosensing cycle is ideal for business and dress shirts. The WRINKLE FREE feature is automatically activated to reduce wrinkling and the need to iron.



Towels

Towels is an autosensing, high heat cycle designed to ensure that towels and thick seams are thoroughly dried.



Soft Toys

This gentle, cool, 20 minute blow dry takes care of the smallest family member's special friends. Repeat cycle if fur or body is not completely dry.



Sports

Outdoor activities can create some unique laundry challenges. We have created four helpful cycles to quickly deal with these situations, with no thinking required.



Sportswear Light

This autosensing cycle uses a low heat to gently dry light synthetic sportswear garments.

Important!

Use of fabric softener may block the performance enhancing features of high-tech sportswear fabrics eg breathability and moisturewicking. Check the care label before drying.



Sportswear Heavy

This extended autosensing, high heat cycle takes care of durable heavy cotton sportswear garments with thick and bulky seams.



Outdoor Wear





Outdoor wear provides a cool cycle ideal for drying high performance fabrics and outdoor items eg waterproof jackets. Please check the care label first.











Protection Equipment

This 40 minute, low heat cycle gently dries padded sports protection items eg gloves and pads. Repeat cycle if necessary.

Below is a selection of care label symbols that garment manufacturers use to show how their garments should be dried. We've converted these symbols into the cycles and heat settings that we recommend you use in the AeroSmart dryer. By following our recommendations, you can ensure that your clothes will retain their appearance over time.

Tumble dry symbols	Normal 	Permanent Press 	Delicate 	Do not Tumble Dry 
Drying cycle we recommend	HEAVY or REGULAR	EASY IRON	DELICATE	Do not place in dryer

Tumble dry symbols	Any Heat 	High 	Medium 	Low 	No Heat 
Drying cycle we recommend	Any cycle	HEAVY or REGULAR	EASY IRON or CASUAL	DELICATE	AIR DRY

Additional drying instructions	Hang to Dry 	Drip Dry 	Dry in Shade 	Dry Flat 
--------------------------------	--	---	---	---

Do not place articles with these symbols in the dryer.

Your AeroSmart dryer locks its lid at the start of the drying cycle, providing added safety for you and your family while it is operating. This lock ensures the lid cannot be opened while the drum is rotating.



Fig.45 Lid locked

A lidlock symbol (padlock) appears in the corner of the screen when locked (it disappears when unlocked). If the lidlock symbol is flashing the lid is in the process of being unlocked. During this stage, the lid still cannot be lifted.

The lid must be closed before the drying cycle can start. If START/PAUSE is pressed with the lid open, the machine will beep and a message will appear in the display screen saying "I can't LOCK THE LID." Close lid and press START, to signal that the lid needs to be closed. Once the lid has been closed and START/PAUSE is pressed, the LID LOCK will be activated and the drying cycle will begin.

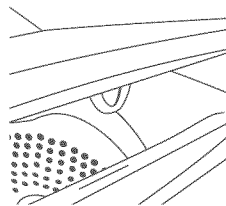

Fig.46 Lid lock mechanism

Power Failure

If the power is cut while your AeroSmart dryer is operating, the lid will be unlocked. In some circumstances the drum door may not be automatically opened. If this occurs it is best if the dryer is not interfered with. When the power is restored the dryer will automatically resume operating. However if it does not automatically open, first close the lid and start the dryer in the usual manner, after 5 seconds press START/PAUSE. This will cause AeroSmart to open correctly with the lid unlocked.

If it is absolutely necessary to remove some items before power is restored follow the steps below:

- 1 Ensure the dryer is disconnected from the power supply.
- 2 Open the lid (this will already be unlocked).
- 3 On the left hand side of the dryer there is a thumb tab that appears when the drum is closed. Press the thumb tab, while rotating the drum by hand away from you (push the drum towards the back of the dryer).
- 4 Hold the thumb tab down until the drum starts opening.
- 5 Keep rotating the drum until it is fully open and it comes to a stop.
- 6 Now you can remove items from the dryer drum.
- 7 Close the lid once you have removed desired items.
- 8 Re-connect the power supply to your dryer.



Fig.47 Opening the drum

The drum door will automatically close and the dryer will resume normal operation when power is restored.

After using your AeroSmart dryer you may wish to fine-tune some of the options to suit your individual needs. Any options changed in this menu are a permanent change, unless 'Reset Defaults' is selected (refer to page 55).

To access the Settings Menu:

- 1 Turn your AeroSmart dryer on.
- 2 Scroll, to the right, through the drying cycles until you reach the Settings Menu. 
- 3 Press SELECT to enter the menu.



Alarm Beeps

The number of beeps that signal the end of the cycle can be altered. Choose between no beeps, five or fifteen beeps.



Screen Brightness

You can adjust the brightness of your screen to suit your individual needs.



Screen Contrast

You can adjust the contrast of your screen to suit your individual needs.



Key Lock mode

Key lock automatically locks the buttons on your AeroSmart when not in use. This will avoid accidental button pushes from items left on the lid of the dryer and also from any little fingers.

To turn Key Lock Mode ON or OFF:

- Access the Settings Menu (refer above).
- Scroll to the KEY LOCK MODE option, and press SELECT.
- Use the SCROLL buttons to select ON or OFF.
- Press SELECT to confirm your selection and return to the Settings Menu.

If Key Lock mode is switched ON:

- To turn your dryer on, **push and hold the POWER button for 3 seconds**. This will activate the display panel. You will then be able to select your drying option and press START. The buttons will then be locked.
- To PAUSE your dryer at any time during the cycle, **press the PAUSE button twice**. This will allow you access to the Cycle Options, then press START to restart your cycle. The buttons will then lock.
- To STOP your dryer and power off, **press the POWER button twice**.

If you can't remember how to unlock the buttons, press any button and the display screen will remind you.



Reminders

How many times have you taken your clothes out of the dryer and realised that you forgot to add the softener sheet when you started the cycle? Or forgotten to remove your delicates half way through the cycle and now they are ruined?

AeroSmart has three helpful automatic reminders to help you to remember those important tasks.

1. Remove Delicates Early

Your dryer will beep and display a message when it senses that the load is nearly dry. You will then be able to remove delicate items and the rest of the load will continue through the remainder of the cycle.

2. Add Softener Sheets

Reminds you to add softener sheets to your load at the beginning of each cycle.

3. Empty Lint Bucket

After every fifth cycle you will be prompted to remove the lint from the lint bucket to keep your dryer clean and lint free.



Hints

Hints screens are provided to help to explain each of the drying choices. Your AeroSmart comes with these hints programmed ON. When you become more experienced with the way your machine functions, you may wish to turn these hints OFF. To do this access the SETTINGS MENU, select HINTS and scroll to OFF. Press the SELECT button to confirm your choice.



Language

AeroSmart is clever enough to be able to communicate in more than one language.

To change the language setting:

- 1 Scroll to the right of the display screen until you reach the SETTINGS MENU. Use the SELECT button to confirm your selection.
- 2 Scroll to the LANGUAGE option and press SELECT.
- 3 Scroll through the language options available and press SELECT to choose your preferred language. Your setting will then be saved.
- 4 If you wish to change the language the dryer is set to in the future, repeat steps 1 – 3.



Service Contacts

In the first instance please refer to “Before You Call for Service” on page 57 for help to try and solve any problem you may encounter. If your problem persists, this option will direct you to the appropriate contact details for help or service.



Trouble Shooting

Help with some of the more common issues you may encounter.



Reset Defaults

If you would like to re-set all settings back to those that were set when your AeroSmart left the factory select RESET FACTORY DEFAULTS.



Replay Intro

This option allows you to replay the introduction explanation for your dryer. This is great for a new user who may not be sure how to use their dryer or what features the dryer has to offer.

Cleaning

Clean your dryer with a soft damp cloth and wipe dry. Do not use scouring cleaners as they can damage the paint and plastic surfaces.

Removing the Lid

You can remove the lid for cleaning. Open the lid fully, hold one side with one hand and tap the other side with an upwards motion. To replace the lid, hold the lid vertically and align both hinges before clicking back into place.

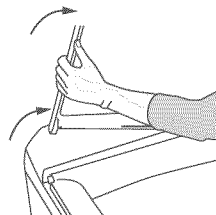

Fig.48 Removing the lid

Pre-Treatment Sprays

Do not use pre-treatment sprays or liquids on or near your dryer as they can damage your machine's control panel as well as any of its plastic parts. Damage to your dryer caused by pre-treatment products will not be covered by your warranty.

Stains

If stains appear inside the drum of your machine, mix a detergent and water paste (or use a non-flammable liquid cleaner) and wipe over the stain with a soft cloth. Then tumble old towels for 20 – 40 minutes on the AIR DRY setting to remove all traces of the cleaner.

Lint Bucket

The lint bucket will need to be emptied before the lint reaches the top of the transparent section. A lint bucket that is not full ensures your clothes will remain lint-free and your dryer will operate at maximum efficiency.



Venting

Inspect and clean all ducting at least once a year to remove accumulated lint. Check frequently that any damper on the exhaust hood moves sufficiently and opens and shuts freely.

Ensure that the area around the dryer is kept clear and free from combustible materials, gasoline and other flammable vapors or liquids. Ensure also that the dryer area is kept clear and free from items that would obstruct the flow of combustion and ventilation air.

Your AeroSmart dryer is capable of diagnosing its own troubles. If your dryer is displaying a message on the display screen and is sounding a musical series of beeps every 5 seconds, it has a problem that you may be able to solve using the checklist below. (It's the same sound AeroSmart dryer makes when you plug it in).

If you are unable to solve the problem from the checklist below call for service.

	Machine is beeping and ... "I can't LOCK THE LID"
	Close the lid and press START/PAUSE.
	If the lid is already closed, open the lid and close it again, then press START/PAUSE.
Disconnect from the power (either by unplugging the dryer or turning off the circuit breaker that supplies it). Wait 10 seconds, reconnect and try turning it on again.	
	Machine is beeping and... "I can't CLOSE THE DRUM"
	The machine is unable to close the drum due to clothes interfering with the closing mechanism. Remove any articles that are interfering with the drum door and dry these in the next load.
	Is your load higher than the top of the lint bucket? Remove some articles and dry these in the next load.
If your dryer is continually beeping and a message is displayed on the screen, a fault has occurred which requires repair from a Service Agent.	

Pressing the POWER button once will stop the beeping but will still display the fault code. We recommend leaving the machine in this mode as the fault code will enable the service person to quickly identify the cause of the problem.

Single beep every second and ...

	"I need SERVICE" message and fault number.
	1. Turn your machine off at the wall.
	2. Wait 1 minute and turn it back on.
	3. Check your machine is level (refer to installation instructions pages 7 – 31).
	4. Remove load and retry.
5. If the fault re-occurs repeat steps 1 and 2.	

If the machine still will not work, call your Fisher & Paykel Dealer or Authorised Service Agent to arrange service (refer to page 62).

Pressing POWER does not turn the dryer on

Is the electrical cord plugged in? If not plug the cord in.

If there is a switch, is it switched on?

Could your household power supply be at fault? (If your plug is suitable, try plugging another electrical appliance into the same outlet).

Check your house circuit breakers and fuses. If they are at fault contact an electrician.

Dryer does not heat

Is the dryer set to the AIR DRY cycle?

Is the gas turned on? (Gas/LPG dryers only).

Has the dryer progressed to COOLING. (Check the Display Screen).

If the problem persists call for service.

Clothes are still wet/damp

Is the dryer set on DAMP?

Try selecting a higher dryness level.

Is the drum warm? If not, is the dryer set to the AIR DRY cycle?

If you have a gas dryer, is the gas turned on? Is your LPG bottle empty?

Try drying similar weight clothes together.

If the problem persists call for service.

Pressing START/PAUSE does not start the dryer

Is the lid open? Shut the lid and press START/PAUSE.

Is there a fault displayed on the display screen? Refer to page 57, – Before you call for service.

Dryer is taking a long time to dry

Is the lint bucket full? If so empty it to improve performance.

Is the airflow system free from obstruction?

If you have a gas dryer, is the gas turned on? Is your LPG bottle empty?

Has the dryer been vented correctly? Is the venting distance too great?

Is the machine over-loaded?

Have heavyweight items been separated from lightweight items?

Are the clothes very wet when they are removed from the washing machine? Increase your washer's spin speed.

Are you using the AIR DRY cycle?

Dryer keeps stopping and starting

Your dryer has a reverse action tumble. When it changes direction it will pause momentarily and will start again in the opposite direction, this is normal.

Has WRINKLE FREE been selected?

Linting Problems

Is the lint bucket full? When lint reaches the top of the transparent section of the bucket it needs emptying.

Have you separated lint-shedding garments (eg towels) from lint receiving garments (eg synthetics).

Have you checked your pockets for tissues or other items that could have been left in them?

Have you over-loaded your dryer? Over-loading can result in linting problems due to reduced airflow and lint not being able to collect on the filter.

Have you over-dried your load? Over-drying can cause lint-attracting static electricity. Try a lower Dryness Setting or use AUTO-SENSING instead of TIME DRY.

Is the lint bucket in place?

Static problems

Have your clothes been over-dried? Choose a lower dryness setting.

Have you used fabric softener? Place fabric softener sheets in the dryer.

Items shrinking

Has the load been over-dried? Choose a lower dryness setting.

Is tumble-drying recommended? Check care labels inside garments.

If you selected TIME DRY - did you set it to dry for too long?

Has the correct temperature been used to dry the garment? Check the care label.

Clothes are wrinkled

Does the load sit higher than the lint bucket? Your dryer is over-loaded, decrease the load size.

Did you remove your clothes as soon as the dryer was finished? Use the WRINKLE FREE option, if you cannot return to the dryer in time.

Have your clothes been over-dried? Select a lower dryness level. Check your garments care-labels.

Drum door will not open

Is the electrical cord plugged in? If not, plug the cord in and switch power on.

A power failure may have occurred. Please refer to page 52 for more information, or contact your Fisher & Paykel Authorised Service Agent.

Lid will not open

Is the WRINKLE FREE option selected? Press START/PAUSE to open the lid.

Dryer has stopped during the cycle with the white WRINKLE FREE light illuminated and the LCD screen blank.

Your dryer may be experiencing a low voltage supply. Without enough electricity it cannot function. Once the line voltage returns to normal the dryer will recommence the interrupted cycle. If the problem persists call for service.

Limited warranty

When you purchase any new Fisher & Paykel whiteware product for personal or consumer use you automatically receive a one year limited warranty covering parts and labor for servicing within the 48 mainland United States, Hawaii, Washington DC and Canada. In Alaska the limited warranty is the same except that you must pay to ship the product to the service shop or the service technician's travel to your home. Products for use in Canada must be purchased through the Canadian distribution channel to ensure regulatory compliance.

If the product is installed in a motor vehicle, boat or similar mobile facility, you receive the same one year limited warranty, but you must bring the vehicle, boat or mobile facility containing the product to the service shop at your expense or pay the service technician's travel to the location of the product.

Fisher & Paykel undertakes to:

Repair without cost to the owner either for material or labor any part of the product, the serial number of which appears on the product, which is found to be defective. In Alaska, you must pay to ship the product to the service shop or for the service technician's travel to your home. If the product is installed in a motor vehicle, boat or similar mobile facility, you must bring it to the service shop at your expense or pay for the service technician's travel to the location of the product. If we are unable to repair a defective part of the product after a reasonable number of attempts, at our option we may replace the part or the product, or we may provide you a full refund of the purchase price of the product (not including installation or other charges).

This warranty extends to the original purchaser and any succeeding owner of the product for products purchased for ordinary single-family home use.

All service under this limited warranty shall be provided by Fisher & Paykel or its Authorized Service Agent during normal business hours.

How long does this limited warranty last?

Our liability under this limited warranty expires ONE YEAR from the date of purchase of the product by the first consumer.

Our liability under any implied warranties, including the implied warranty of merchantability (an unwritten warranty that the product is fit for ordinary use) also expires ONE YEAR (or such longer period as required by applicable law) from the date of purchase of the product by the first consumer. Some States do not allow limitations on how long an implied warranty lasts, so this limit on implied warranties may not apply to you.

This warranty does not cover:

- A** Service calls that are not related to any defect in the product. The cost of a service call will be charged if the problem is not found to be a defect of the product. For example:
 1. Correct faulty installation of the product.
 2. Instruct you how to use the product.
 3. Replace house fuses, reset circuit breakers, correct house wiring or plumbing, or replace light bulbs.
 4. Correct fault(s) caused by the user.
 5. Change the set-up of the product.
 6. Unauthorized modifications of the product.
 7. Noise or vibration that is considered normal, for example, drain/fan sounds, refrigeration noises or user warning beeps.
 8. Correcting damage caused by pests, for example, rats, cockroaches etc.
- B** Defects caused by factors other than:
 1. Normal domestic use or
 2. Use in accordance with the product's user guide.
- C** Defects to the product caused by accident, neglect, misuse, fire, flood or Act of God.
- D** The cost of repairs carried out by non-authorized repairers or the cost of correcting such unauthorized repairs.
- E** Travel fees and associated charges incurred when the product is installed in a location with limited or restricted access. (eg airplane flights, ferry charges, isolated geographic areas).
- F** Normal recommended maintenance as set forth in the product's user guide.

If you have an installation problem contact your dealer or installer. You are responsible for providing adequate electrical, exhausting and other connection facilities.

We are not responsible for consequential or incidental damages (the cost of repairing or replacing other property damaged if the product is defective or any of your expenses caused if the product is defective). Some States do not allow the exclusion or limitation of incidental or consequential damages, so the above limitation or exclusion may not apply to you.

How to get service

Please read your User Guide. If you then have any questions about operating the product, need the name of your local Fisher & Paykel Authorized Service Agent, or believe the product is defective and wish service under this limited warranty, please contact your dealer or call us at:

USA and Canada

TOLL FREE 1.888.9.FNP.USA (1.888.936.7872)

or use the link at: www.fisherpaykel.com/locator/servicer/

You may be required to provide reasonable proof of the date of purchase of the product before the product will be serviced under this limited warranty.

Commercial use

If you are using the product in a commercial setting (any use other than a single family dwelling), we agree to repair or replace, without cost to you for parts only, any defective parts, the serial number of which appears on the product. Our liability for these repairs expires ONE YEAR from the date of original purchase.

At our option we may replace the part or the product, or we may provide you a full refund of the purchase price of the product (not including installation or other charges). All service under this limited warranty shall be provided by Fisher & Paykel or its Authorized Service Agent during normal business hours.

No other warranties

This limited warranty is the complete and exclusive agreement between you and Fisher & Paykel regarding any defect in the product. None of our employees (or our Authorized Service Agents) are authorized to make any addition or modification to this limited warranty.

Warrantor: Fisher & Paykel Appliances, Inc.

If you need further help concerning this limited warranty, please call us at above number, or write to:

Fisher & Paykel Appliances, Inc.
5900 Skylab Road
Huntington Beach
CA 92647

This limited warranty gives you specific legal rights, and you may also have other rights which vary from state to state.

Copyright © Fisher & Paykel 2009. All rights reserved.
The product specifications in this booklet apply to the specific products and models described at the date of issue. Under our policy of continuous product improvement, these specifications may change at any time. You should therefore check with our Customer Care Center to ensure this booklet correctly describes the product currently available.

www.fisherpaykel.com
www.fisherpaykel.ca

US/CA
AeroSmart clothes dryer
Installation instructions and user guide
Published 02/2009
Part No. 395778