



LG

Life's Good

OWNER'S MANUAL

LED LCD TV / PLASMA TV

Please read this manual carefully before operating your set and retain it for future reference.

LED LCD TV MODELS

47LX9500
55LX9500
47LEX8
55LEX8
60LEX9
72LEX9

PLASMA TV MODELS

50PK950
60PK950

NETWORK

LEGAL NOTICE

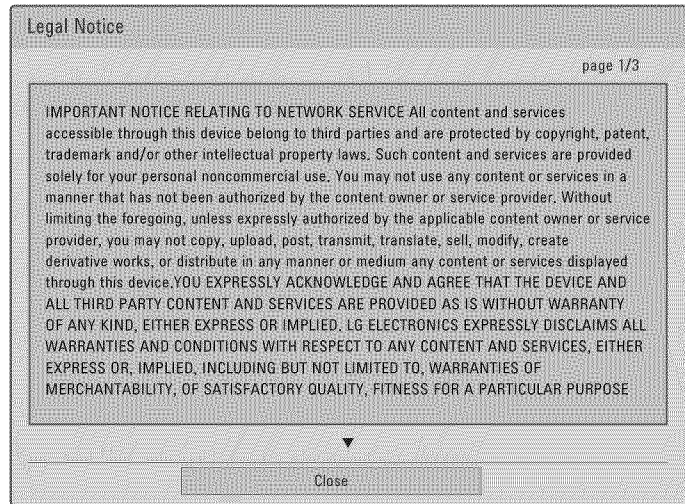
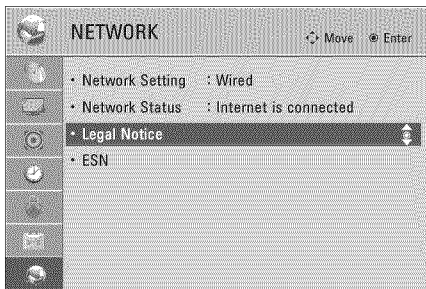

NETWORK

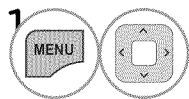

Select **NETWORK**.

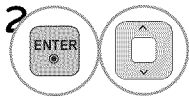

Select **Legal Notice**.

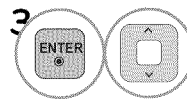

Check Legal notice.



Return to TV viewing.

IMPORTANT NOTICE RELATING TO NETWORK SERVICE

All content and services accessible through this device belong to third parties and are protected by copyright, patent, trademark and/or other intellectual property laws. Such content and services are provided solely for your personal noncommercial use. You may not use any content or services in a manner that has not been authorized by the content owner or service provider. Without limiting the foregoing, unless expressly authorized by the applicable content owner or service provider, you may not copy, upload, post, transmit, translate, sell, modify, create derivative works, or distribute in any manner or medium any content or services displayed through this device.

YOU EXPRESSLY ACKNOWLEDGE AND AGREE THAT THE DEVICE AND ALL THIRD PARTY CONTENT AND SERVICES ARE PROVIDED "AS IS" WITHOUT WARRANTY OF ANY KIND, EITHER EXPRESS OR IMPLIED. LG ELECTRONICS EXPRESSLY DISCLAIMS ALL WARRANTIES AND CONDITIONS WITH RESPECT TO ANY CONTENT AND SERVICES, EITHER EXPRESS OR IMPLIED, INCLUDING BUT NOT LIMITED TO, WARRANTIES OF MERCHANTABILITY, OF SATISFACTORY QUALITY, FITNESS FOR A PARTICULAR PURPOSE, AND NON-INFRINGEMENT OF THIRD PARTY RIGHTS. LG DOES NOT GUARANTEE THE ACCURACY, VALIDITY, TIMELINESS, LEGALITY, OR COMPLETENESS OF ANY CONTENT OR SERVICE MADE AVAILABLE THROUGH THIS DEVICE AND DOES NOT WARRANT THAT THE DEVICE OR SERVICES WILL MEET YOUR REQUIREMENTS, OR THAT OPERATION OF THE

DEVICE OR SERVICES WILL BE UNINTERRUPTED OR ERROR-FREE. UNDER NO CIRCUMSTANCES, INCLUDING NEGLIGENCE, SHALL LG BE LIABLE, WHETHER IN CONTRACT OR TORT, FOR ANY DIRECT, INDIRECT, INCIDENTAL, SPECIAL OR CONSEQUENTIAL DAMAGES, OR ANY OTHER DAMAGES ARISING OUT OF, ANY INFORMATION CONTAINED IN, OR ANY CONTENT OR SERVICE ACCESSED BY YOU OR ANY THIRD PARTY, EVEN IF ADVISED OF THE POSSIBILITY OF SUCH DAMAGES.

Third party services may be changed, suspended, removed, terminated or interrupted, or access may be disabled at any time, without notice, and LG makes no representation or warranty that any content or service will remain available for any period of time. Content and services are transmitted by third parties by means of networks and transmission facilities over which LG has no control. LG may impose limits on the use of or access to certain services or content, in any case and without notice or liability. LG expressly disclaims any responsibility or liability for any change, interruption, disabling, removal of or suspension of any content or service made available through this device.

LG is neither responsible nor liable for customer service related to the content and services. Any question or request for service relating to the content or services should be made directly to the respective content and service providers.

NETCAST

NETCAST MENU

These services are provided by separate Content Provider.
NETCAST menu source can differ by country.

What is a NETCAST?

Stream movies, TV shows and video, or get up to the minute news, stock information or weather updates directly to your TV.

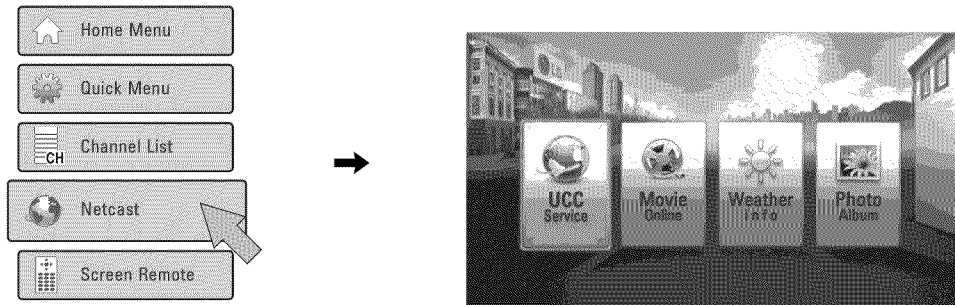

1. Select **NetCast**.
2. Select **NETCAST** menu option.
Enjoy **Online Service**.

- To view the owner's manual that provided by the Content Provider, visit our website at <http://www.lg.com>.
- To see the activation method of Yahoo!, Netflix, or Vudu, click the **Yahoo!**, **Netflix**, **Vudu** in the CD manual (For USA).
- You can also select the **NETCAST** using the NETCAST button on the TV remote control.

■ Yahoo! (For USA)

Yahoo! TV Widgets give you the best of the Internet in perfect harmony with the simplicity and reliability of your TV. TV Widgets deliver a Cinematic internet™ experience by converting your favorite web services for viewing on the TV.

■ Netflix (For USA)

You can instantly watch movies (quite a few new releases) & TV episodes from Netflix streamed over the internet to your TV.

To become a Netflix member visit: www.netflix.com/LG

Note that this service is provided by the Content Provider, Netflix. It is dependent on Netflix to provide the data.

■ Vudu (For USA)

In order to make rental/purchase transactions on the Vudu service, a user must create an account on vudu.com.

That account is linked to a specific device, via a process called "activation". It is possible to have multiple devices associated with a single Vudu account.

Note that this service is provided by the Content Provider, Vudu. It is dependent on Vudu to provide the data.

■ YouTube

YouTube is a video sharing website where users can upload, view, and share video clips.

■ Picasa

Picasa is an application from Google that appreciates digital image files.

NOTE

- ▶ The videos list searched from the TV may differ with the list searched from a web browser on PC.
- ▶ The settings of this TV do not affect the YouTube's playback quality.
- ▶ The playback of videos may be paused, stopped or buffering occurring often depending on your broadband speed.
- ▶ For service that requires log in, join the applicable service on the website using the PC and log in through the TV to enjoy various additional functionalities.
- ▶ When you set the city you want with Setup by pressing the red button, the background of NetCast will be set to the weather of the selected city.
- ▶ For Plasma TV: If there is no user action 2 minutes following freezing image or video on screen, the screensaver will activate itself preventing fixed image remaining on screen.

NETCAST

YOUTUBE

YouTube is a video sharing website where users can upload, view, and share video clips.

Screen Components

- ① YouTube menu
- ② Videos list



	Set the option menu.
	Return to Netcast menu.
	Return to TV viewing.

NOTE

- ▶ When you press the Q.menu button while the Youtube video is playing in full mode, you can set the video options.

YouTube menu

Home: You can watch the popular video in real time.

Featured: The featured videos list will be displayed.

Popular: The best rated videos list from YouTube server will be displayed.

Most Viewed: The most viewed videos list will be displayed.







Search: The keypad/keyboard menu will be displayed.

History: The videos list that you previously played will be displayed. Maximum of 20 videos can be stored.

Favorites: In sign-in status, this menu will be displayed the videos list that is arranged in the YouTube server with your account (Some videos may not appear on the **Favorites** list, even if the videos are arranged in the server).

Sign in (Sign Out): Displays the keypad/keyboard menu to sign in or returns to the sign-out status.

Using the remote control

	Stops the video and displays related videos list.
	Pause the video while it is playing.
	Play the selected video.
	Skip the playback forward or backward.
	Set the option menu.
	Return to Netcast menu.
	Return to TV viewing.

NETCAST





PICASA

Picasa is a photo organizing or sharing website where users can upload, view, and share photos.

Screen Components

- ① Picasa menu
- ② Photo list



	Navigate the desired photos.
	The selected photo file is displayed.
	Return to Netcast menu.
	Return to TV viewing.

Picasa menu

Home: The featured photos list will be displayed.

Friends: You can register users with the pictures you want as friends. You can add up to 10 friends.

Search: The keypad/keyboard menu will be displayed.

My Photos: You can view the pictures uploaded to the Web. This function can only be used when you sign in.





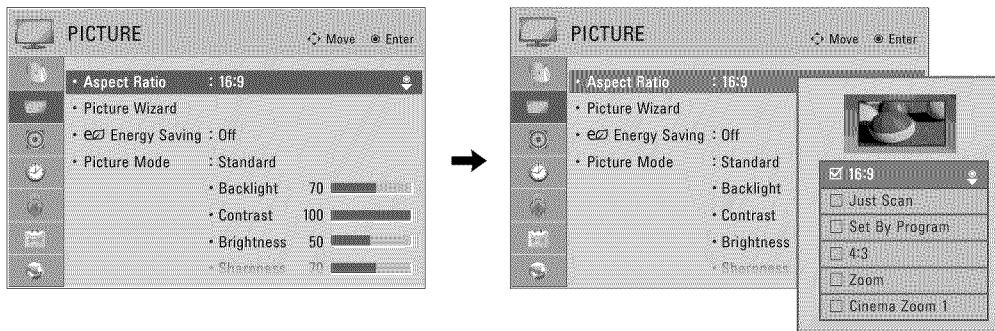

Sign in (Sign Out): Displays the keypad/keyboard menu to sign in or returns to the sign-out status.

PICTURE CONTROL

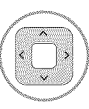
PICTURE SIZE (ASPECT RATIO) CONTROL

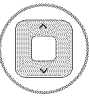

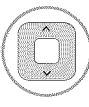
This feature lets you choose the way an analog picture with a 4:3 aspect ratio is displayed on your TV. You can select a different aspect ratio depending on input source (analog broadcasting, digital broadcasting, aux).



- 1   Select **PICTURE**.
- 2   Select **Aspect Ratio**.
- 3   Select the desired picture format.
- 4  Return to the previous menu.
-  Return to TV viewing.

- You can also adjust **Aspect Ratio** in the **Q.MENU**.
- Press the **RATIO** button repeatedly to select the desired picture format.

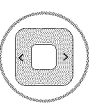
When adjusting Zoom or Cinema Zoom in Q.MENU

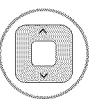
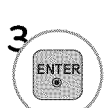
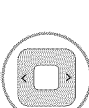
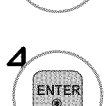
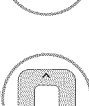
- 1   Select **Aspect Ratio**.
- 2   Select **Zoom** or **Cinema Zoom**.
- 3   Adjust proportion of Zoom or Cinema Zoom. The Cinema Zoom adjustment range is 1-16.
- 4   Move the image on the screen.

16:9

Adjust the picture horizontally, in a linear proportion to fill the entire screen.

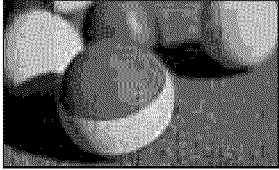

Just Scan

Normally the edges of video signals are cropped 1-2%. Just Scan turns off this cropping and shows the complete video.

Notes: If there is noise on the edges of the original signal, it will be visible when Just Scan is activated.

Just Scan operates only in DTV/Cable DTV/Component/HDMI-DTV/DVI-DTV (720p/1080i/1080p) input source.



Set By Program

Selects the proper picture proportion to match the source's image.

(4:3 → 4:3)



(16:9 → 16:9)



4:3

Choose 4:3 when you want to view a picture with an original 4:3 aspect ratio.

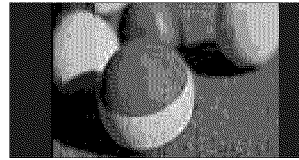

Zoom

Choose Zoom when you want to view the picture without any alteration. However, the top and bottom portions of the picture will be cropped.

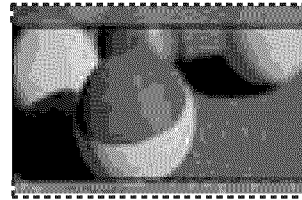

Cinema Zoom

Choose Cinema Zoom when you want to enlarge the picture in correct proportion.

This enlarges an image with cinemascope aspect ratio (2.35:1) without distortion.

Note: When enlarging or reducing the picture, the image may become distorted.

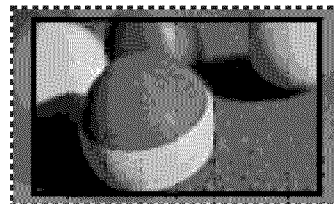

PICTURE CONTROL

PICTURE WIZARD

This feature lets you adjust the picture quality of the original image. Use this to calibrate the screen quality by adjusting the Black and White Level etc. You can calibrate the screen quality by easily following each step. When you adjust the image to **Low**, **Recommended** or **High**, you can see the example of the changes you made.

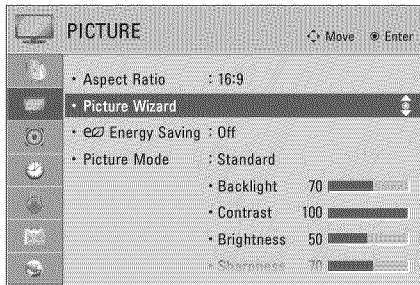

1 Select **PICTURE**.

2 Select **Picture Wizard**.



3 Adjust **Picture Wizard**.



4 Adjust **Standard/Preferred**.

■ If you select **Preferred**, OSD (On Screen Display) differ from that shown in this manual.

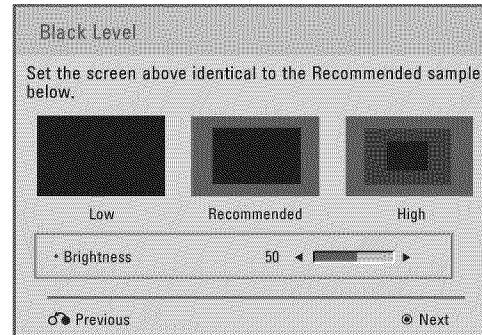

5 Adjust **Black Level**.

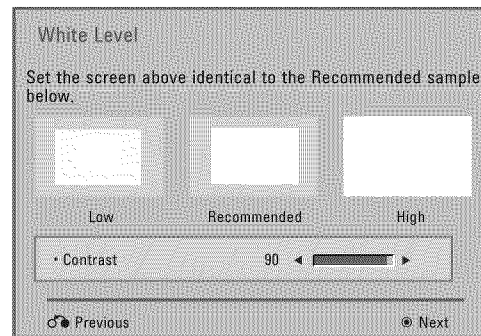

6 Adjust **White Level**.

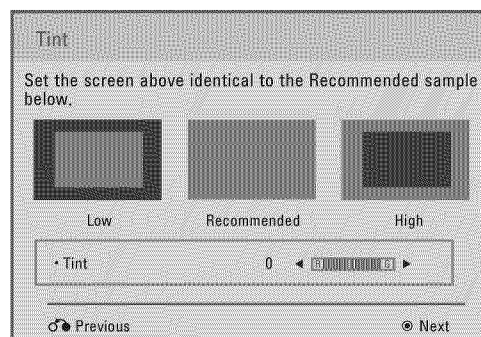

7 Adjust **Tint**.

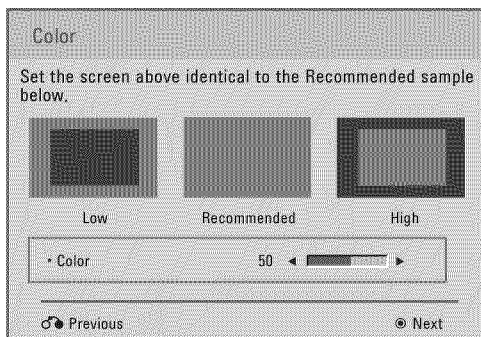

8   Adjust **Color**.

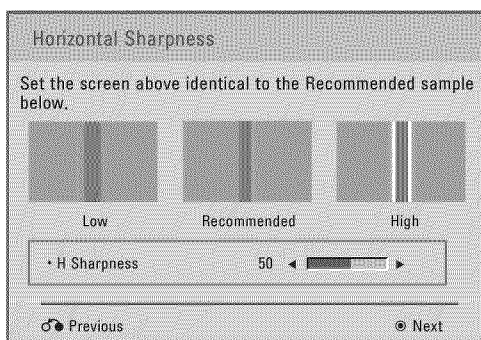

9   Adjust **Horizontal Sharpness**.

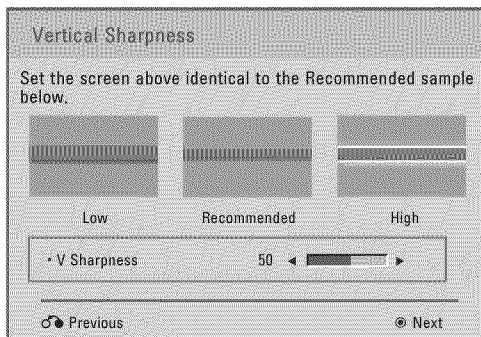

10   Adjust **Vertical Sharpness**.

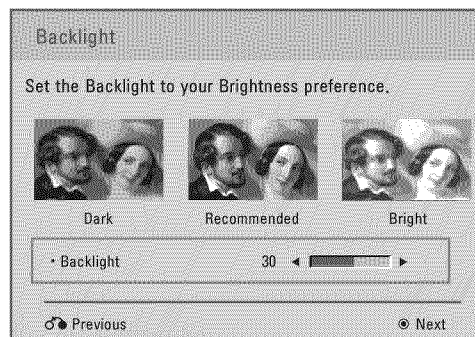

For LED LCD TV

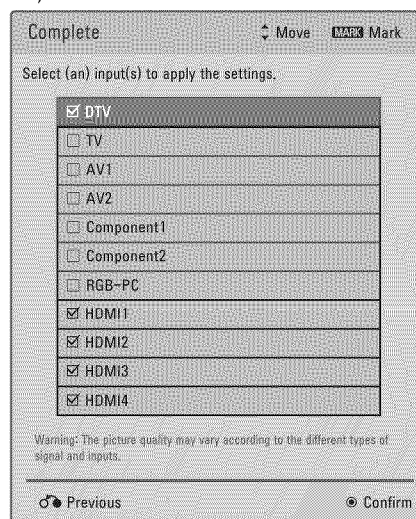

11   Adjust **Backlight**.

i.e)



12   Select input source to apply the settings.

13  Save.

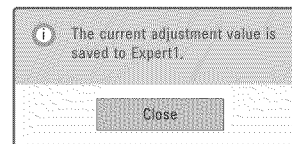

14  Finish the Picture Wizard.

- If you stop the Picture Wizard before the final step, the changes will not be saved to the TV.
- Once the **Picture Wizard** sets the picture quality, **Energy Saving** is changed to **Off** automatically.
- To reset changes made by **Picture Wizard**, operate **Picture Reset** when **Picture Mode** is on **Expert1**.

PICTURE CONTROL

e ENERGY SAVING

It reduces the TV's power consumption.

The default factory setting is adjusted to the comfortable level to be viewed at home.

You can increase the brightness of your screen by adjusting the **Energy Saving** level or by adjusting the **Picture Mode**.

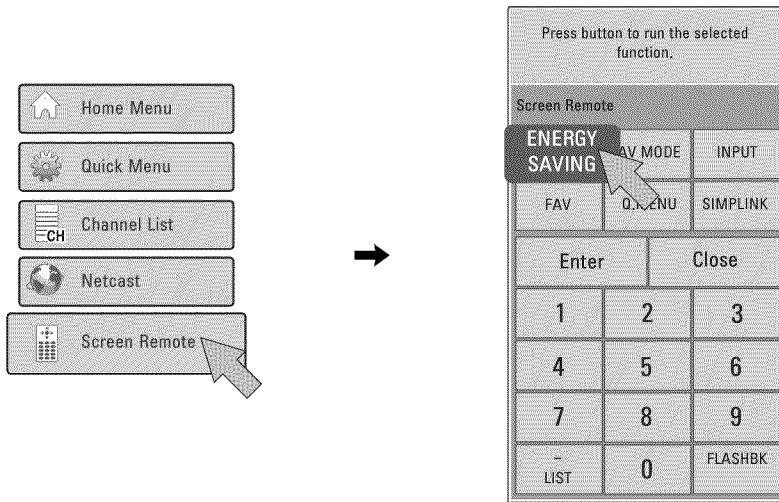

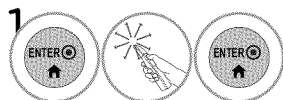
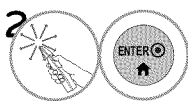
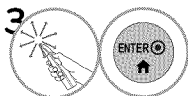
-  Select **Screen Remote**.
-  Select **ENERGY SAVING**.
-  Select **ENERGY SAVING** repeatedly to select your desired menu option.

- When selecting **Screen off**, the screen will turn off after 3 seconds. Pressing any button of the remote controller will turn on the screen again.
- If you adjust "**Energy Saving-Auto, Maximum**", **Backlight** option will not work (For LED LCD TV).
- When selecting "**Energy Saving - Off, Minimum, or Medium**", you can adjust **Backlight** feature (For LED LCD TV).
- If you adjust "Energy Saving-Intelligent Sensor", Sharpness, Color, Color Temperature feature will not work (For Plasma TV).
- When selecting **Auto**, **Backlight** is automatically adjusted through **Intelligent Sensor** according to the surrounding conditions. (For LED LCD TV)
- When selecting **Off**, **Energy Saving** is not used.
- Press the **ENERGY SAVING** button repeatedly to select the appropriate Energy Saving.
- You can also adjust **Energy Saving** in the **PICTURE** menu.
- **Intelligent Sensor**: The most suitable picture is automatically adjusted according to the surrounding conditions (For Plasma TV).

PRESET PICTURE SETTINGS (PICTURE MODE)

There are factory presets for picture settings available in the user menus. You can use a preset, change each setting manually, or use the Intelligent Sensor.

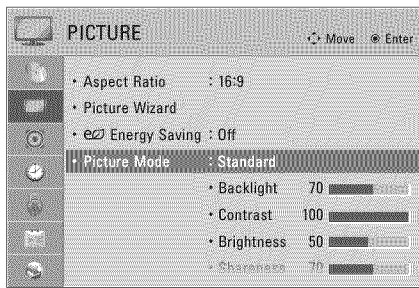

Other models

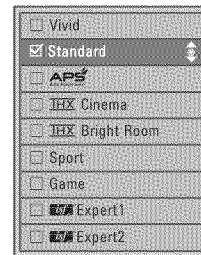

Plasma TV

- 1 Select **PICTURE**.
- 2 Select **Picture Mode**.
- 3 Select your desired menu option.

- 4 Return to the previous menu.
- Return to TV viewing.

- **Vivid, Standard, Cinema, Sport, and Game** Settings are preset for the optimum picture quality at the factory.
- **Vivid:** This is the mode to maximize the effect of the video in the retail store. Strengthen the contrast, brightness, color and sharpness for vivid picture.
- **Standard:** This is the mode to realize optimum viewing condition for the general user.
- **APS (Auto Power Saving):** This is the mode to maximize reducing the power consumption without hurting the picture quality. This feature is available only on Plasma TV.
- **Cinema:** This mode optimizes video for watching movies.
- **THX Cinema:** This is cinema quality mode to provide you the experience of watching a movie at home. The user will be able to enjoy the best level of satisfactory screen quality in any movie without any separate adjustments. **THX Cinema** expresses the optimal screen quality when it is darkest.

When selecting **THX Cinema**, Aspect ratio changes to Just scan.

- **THX Bright Room:** This is the specification to optimize TV viewing in Bright Room. When selecting **THX Bright Room**, Aspect ratio changes to Just scan.
- **Sport:** This is the video mode to emphasize dynamic video and primary color (e.g. white, uniform, grass, sky blue etc.) by realizing the optimal screen for sports.
- **Game:** This is the mode to realize fast response speed in a fast gaming screen.
- **Expert:** This is the mode to adjust the video in detail for video quality expert and general user.
- You can also adjust **Picture Mode** in the **Q.MENU**.
- When selecting **Intelligent Sensor**, **Energy Saving** is changed to **Auto** automatically (For LED LCD TV).
- When selecting **Intelligent Sensor**, it changes Backlight, contrast, brightness, sharpness, color, tint and color temperature automatically (For LED LCD TV).
- **Intelligent Sensor:** The most suitable picture is automatically adjusted according to the surrounding conditions.

PICTURE CONTROL

MANUAL PICTURE ADJUSTMENT - USER MODE

Adjust the picture appearance to suit your preference and viewing situations.

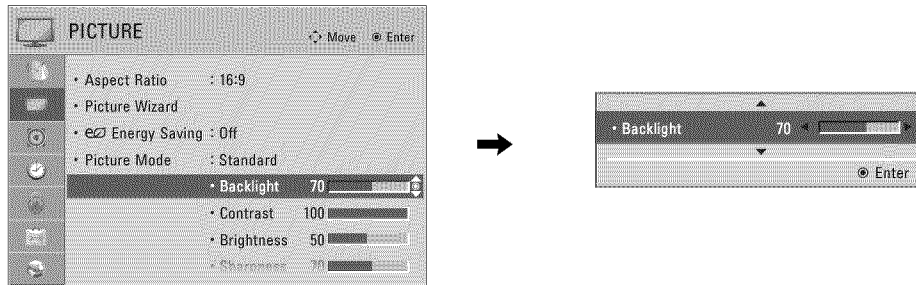

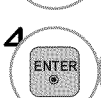
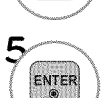
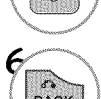
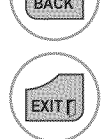







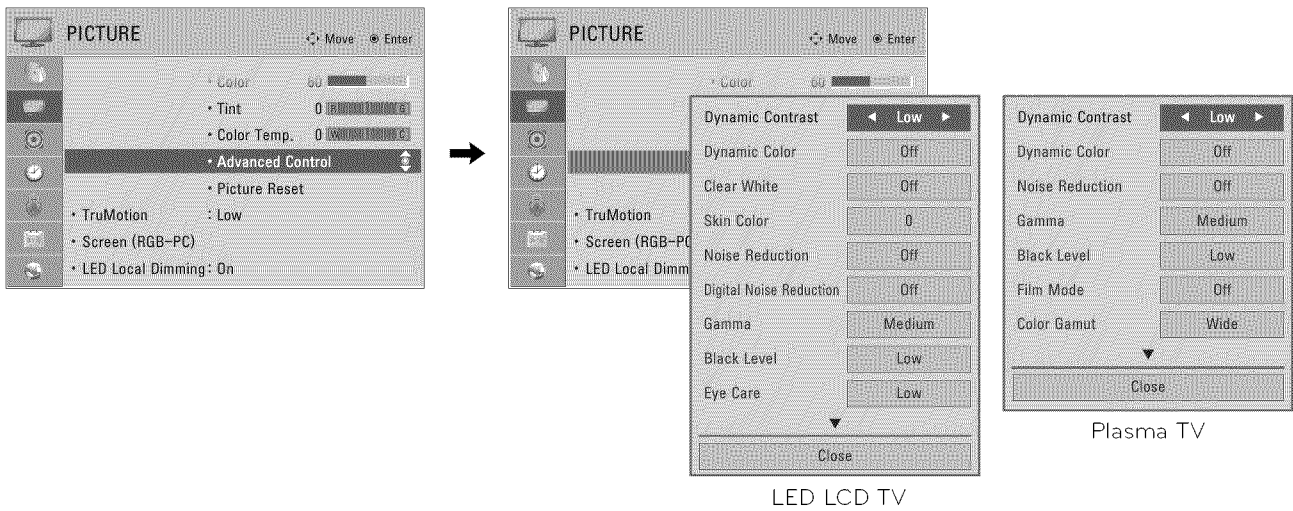

-   Select **PICTURE**.
-   Select **Picture Mode**.
-   Select your desired menu option.
-   Select **Backlight** (For LED LCD TV), **Contrast**, **Brightness**, **Sharpness**, **Color**, **Tint**, **Color Temp.**, or **Advanced Control**.
-   Make appropriate adjustments.
-  Return to the previous menu.
-  Return to TV viewing.

- **Backlight** (For LED LCD TV): This function adjusts the brightness of the backlight behind the LCD screen. Adjusting the backlight is recommended when setting the brightness of the TV. When decreasing the backlight, the brightness of the black becomes darker without any loss in video signal and the power consumption is reduced.
- **Backlight** can only be adjusted in "Energy Saving - Off, Minimum, or Medium".
- **Contrast**: Increase or decrease the gradient of the video signal. You may use Contrast when the bright part of the picture is saturated.
- **Brightness**: Adjusts the base level of the signal in the picture. You may use Brightness when the dark part of the picture is saturated.
- **Sharpness**: Adjusts the level of crispness in the edges between the light and dark areas of the picture. The lower the level, the softer the image.
- **Color**: Adjusts intensity of all colors.
- **Tint**: Adjusts the balance between red and green levels.
- **Color Temp.**: Set to warm to enhance hotter colors such as red, or set to cool to enhance cooler colors such as blue.

PICTURE IMPROVEMENT TECHNOLOGY (ADVANCED CONTROL)

Advanced Control allows you to adjust some of the advanced features of your LG display. To reset to the factory default after making adjustments to each input source, execute the **Picture Reset** function for each Picture Mode.



- 1   Select **PICTURE**.
- 2   Select **Advanced Control**.
- 3   Select your desired menu option.
- 4  Make appropriate adjustments.
- 5  Return to the previous menu.
-  Return to TV viewing.

PICTURE CONTROL

EXPERT PICTURE CONTROL

Expert1 and Expert2 provide even more advanced picture settings for users. Typical used by professionals for calibrating the TV.

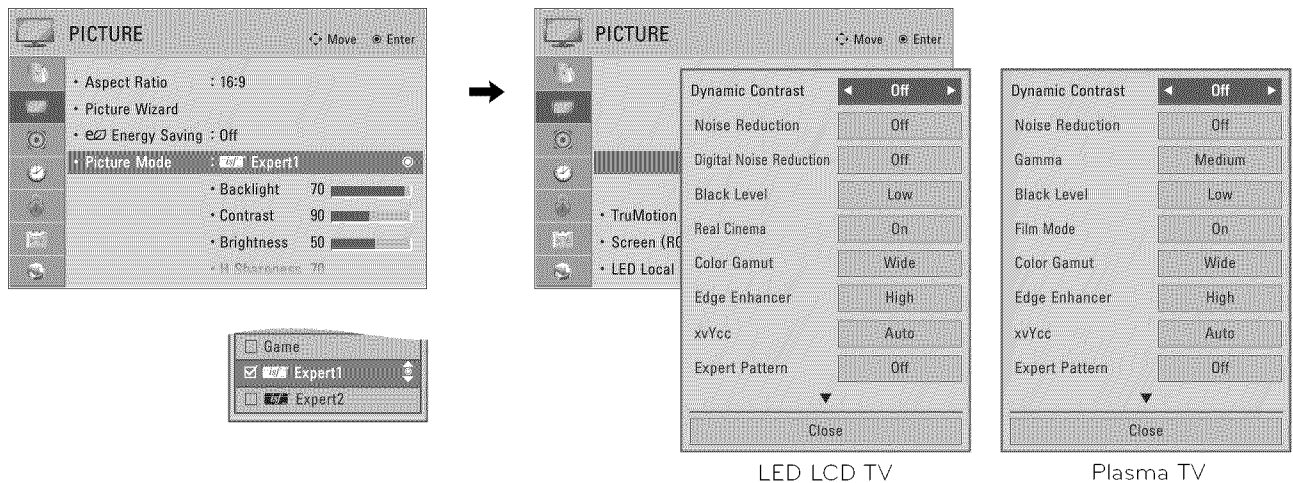

- 1 Select **PICTURE**.
- 2 Select **Picture Mode**.
- 3 Select **Expert1** or **Expert2**.
- 4 Select **Expert Control**.
- 5 Select your desired menu option.
- 6 Make appropriate adjustments.
- 7 Return to the previous menu.
- Return to TV viewing.

*This feature is not available for all models.

Dynamic Contrast	<ul style="list-style-type: none"> Adjusts the contrast to keep it at the best level according to the brightness of the screen. The picture is improved by making bright parts brighter and dark parts darker.
Dynamic Color	<ul style="list-style-type: none"> Adjusts screen colors so that they look livelier, richer and clearer. This feature enhances hue, saturation and luminance so that red, blue, and green look more vivid.
Skin Color	<ul style="list-style-type: none"> It detects the skin area of video and adjusts it to express a natural skin color.
Noise Reduction	<ul style="list-style-type: none"> Reduces screen noise without compromising video quality.
Digital Noise Reduction	<ul style="list-style-type: none"> Removes noise caused by compressing video.
Gamma	<ul style="list-style-type: none"> You can adjust brightness of dark areas and middle gray level areas of the picture. Low : Make brighter and middle gray level areas of the picture brighter. Medium : Express original picture levels. High: Make dark and middle gray level areas of the picture darker.
Black Level	<p>Low: The reflection of the screen gets darker. High: The reflection of the screen gets brighter.</p> <ul style="list-style-type: none"> Set black level of the screen to proper level. This function is available in the following modes: TV, AV (NTSC-M), HDMI or Component.
Clear White	<ul style="list-style-type: none"> Make the white area of screen brighter and more white.
Eye Care	<ul style="list-style-type: none"> Adjust the brightness of the screen to prevent the screen from being too bright. Dims extremely bright pictures. This feature is enabled in "Picture Mode-Standard, Sports, Game".
Real Cinema or Film Mode	<ul style="list-style-type: none"> Makes video clips recorded in film look more natural by eliminating judder effect. DVD and Blu-ray movies are filmed at 24 frames per second (fps). With LG Real Cinema, every frame is consistently processed 5 times in 1/24 of a second producing 120 fps with TruMotion or 2 times in 1/24 of a second producing 48 fps without TruMotion, thus totally eliminating the judder effect. This function can also work when TruMotion is off.
Color Gamut	<p>LED LCD TV: Advanced Control Plasma TV: Advanced Control, Expert Control</p> <p>Standard/sRGB: Displays standard set of colors. Wide: Increase number of colors used.</p> <ul style="list-style-type: none"> Maximize the utilization of colors to increase color quality. <p>LED LCD TV: Expert Control</p> <ul style="list-style-type: none"> Displays color domain of the signal. Standard: Displays standard set of colors. Wide: Increase number of colors used. EBU: Mode to display EBU standard color area. SMPTE: Mode to display SMPTE standard color area. BT709: Mode to display BT709 standard color area.



PICTURE CONTROL

Edge Enhancer	<ul style="list-style-type: none"> Show clearer and distinctive yet natural edges in the video.
xvYCC	<ul style="list-style-type: none"> This produces richer colors. This feature represents rich color as much as conventional video signal. This function is enabled in "Picture mode - Cinema / THX Cinema / THX Bright Room,  Expert" when a xvYCC signal is inputted through HDMI.
Color Filter	<ul style="list-style-type: none"> This function filters specific colors in the video. You can use the RGB filter to set color saturation and hue accurately.
Expert Pattern	<ul style="list-style-type: none"> This is a pattern used for expert adjustment. This function is enabled in "Picture mode -  Expert" when you watch DTV.
Color Temperature	<ul style="list-style-type: none"> Adjusts the overall color of the screen by changing the white baseline. <ol style="list-style-type: none"> Gamma : Select 1.9, 2.2, 2.4 Method : 2 Points <ul style="list-style-type: none"> Pattern: Inner, Outer Red/Green/Blue Contrast, Red/Green/Blue Brightness: The adjustment range is -50 - +50. c-1. Method : 10 Point IRE (LED LCD TV) <ul style="list-style-type: none"> Pattern: Inner, Outer IRE (Institute of Radio Engineers) is the unit to display the size of the video signal and can be set among 10, 20, 30 - 100. You can adjust Red, Green or Blue according to each setting. Luminance: This function displays calculated luminance value for 2.2 gamma. You can input luminance value you want at 100 IRE, then the target luminance value for 2.2 gamma is displayed at every 10 steps from 10 IRE to 90 IRE. Red/Green/Blue: The adjustment range is -50 - +50. c-2. Method : 20 Point IRE (Plasma TV) <ul style="list-style-type: none"> IRE (Institute of Radio Engineers) is the unit to display the size of the video signal and can be set among 5, 10, 15 - 100. You can adjust Red, Green or Blue according to each setting. Red/Green/Blue: The adjustment range is -50 - +50. d. Apply to all inputs
Color Management System	<ul style="list-style-type: none"> A tool used by the experts to make adjustments by using the test patterns, this does not affect other colors but can be used to selectively adjust the 6 color areas (Red/Green/Blue/Cyan/Mgt/Yellow). Color difference may not be distinctive even when you make the adjustments for the general video. Adjusts Red/Green/Blue/Yellow/Cyan, Magenta. <ul style="list-style-type: none"> Red/Green/Blue/Yellow/Cyan/Magenta Color: The adjustment range is -30 - +30. Red/Green/Blue/Yellow/Cyan/Magenta Tint: The adjustment range is -30 - +30. This feature is disabled in RGB-PC and HDMI-PC mode.

PICTURE RESET

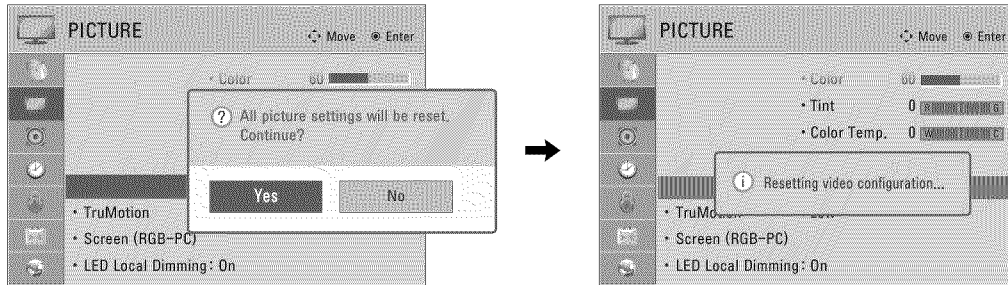
Settings of the selected picture modes return to the default factory settings.







-   Select **PICTURE**.
-   Select **Picture Reset**.
-   Select **Yes**.
-  Initialize the adjusted value.
-  Return to TV viewing.

PICTURE CONTROL

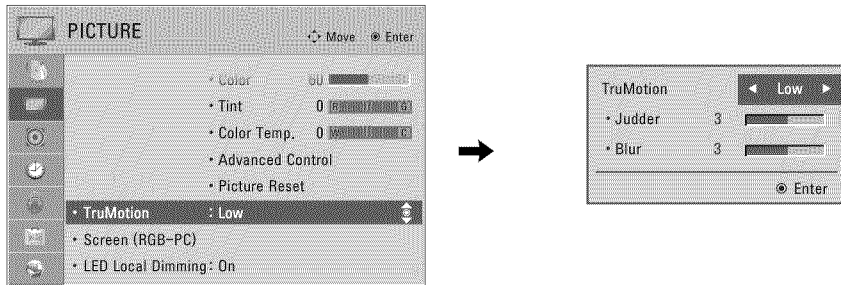

TRUMOTION - For LED LCD TV

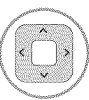
Advance video technology that provides clearer, smoother images, even during fast action scenes creating a more stable structure for a crisper picture.

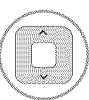
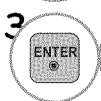
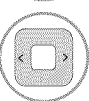

- 1   Select **PICTURE**.
- 2   Select **TruMotion**.
- 3   Select **Low, High, User, or Off**.

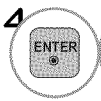
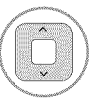
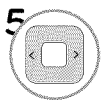
Adjustment for TruMotion (Judder and Blur) with selecting User







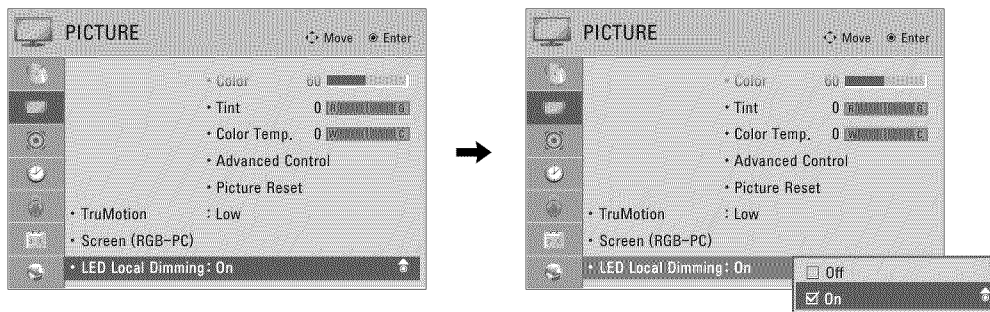

- 4   Select **Judder** or **Blur**.
- 5  Make appropriate adjustments.
- 6  Return to the previous menu.
-  Return to TV viewing.

- **Off**: Turn off **TruMotion** operation.
- **Low**: Provides smooth picture movement. Use this setting for standard use.
- **High**: Provides smoother picture movement.
- **Judder**: Adjusts noise of the screen.
- **Blur**: Adjusts after-image of the screen.
- **TruMotion** works with all inputs except PC mode.
- If you enable "**TruMotion**", noise may appear on the screen. If this occurs, set "**TruMotion**" to "**Off**".
- If you select "**Picture Mode-Game**" set "**TruMotion**" to "**Off**".

LED LOCAL DIMMING - For LED LCD TV

After analyzing the signal of the input video by areas of the screen, it adjusts the backlight to improve the contrast ratio. This feature is disabled in "Picture Mode-Game".









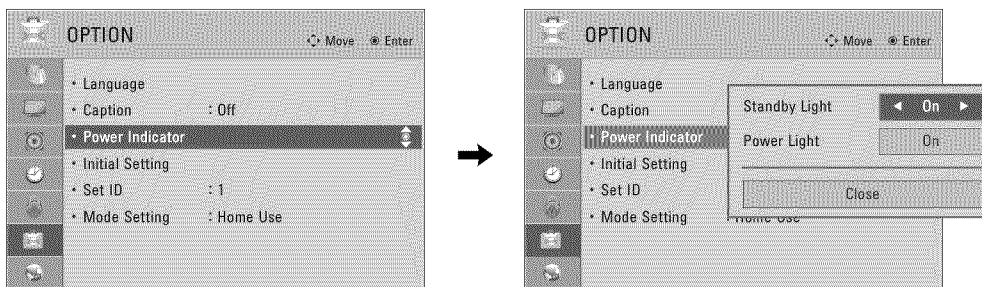

- 1   Select **PICTURE**.
- 2   Select **LED Local Dimming**.
- 3   Select **On** or **Off**.
- 4  Return to the previous menu.
-  Return to TV viewing.

PICTURE CONTROL

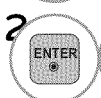
POWER INDICATOR - For LED LCD TV

Adjust the power/standby indicator light on the front of the TV.

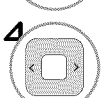







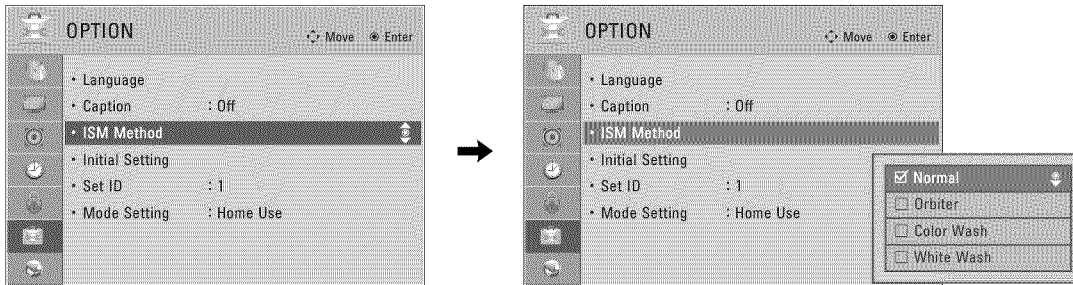

- 1   Select **OPTION**.
- 2   Select **Power Indicator**.
- 3   Select **Standby Light** or **Power Light**.
- 4  Select your desired options.
- 5  Return to the previous menu.
-  Return to TV viewing.

- **Standby Light:** Determines whether to set the indicator light on the front of the TV to **On** or **Off** in standby mode.
- **Power Light:** Determines whether to set the indicator light on the front of the TV to **On** or **Off** when the power turns on.
- If you select 3D mode, "**Power Indicator**" is turned off automatically (Except 50/60PK950).

IMAGE STICKING MINIMIZATION (ISM) METHOD - For Plasma TV

A frozen still picture displayed on the screen for prolonged periods can result in a ghost image. You can use Orbiter to help prevent image sticking. The other two functions are for removing a ghost image.



- 1   Select **OPTION**.
- 2   Select **ISM Method**.
- 3   Select **Normal, Orbiter, Color Wash, or White Wash**.
- 4  Return to TV viewing.

- **Normal:** If image sticking is never a problem, ISM is not necessary - set to Normal.
- **Orbiter:** To avoid a ghost image on the screen, the image will move every 2 minutes to help prevent ghost images. However, it is best not to allow any fixed image to remain on the screen.
- **Color Wash:** The color block with the screen moved a little and the white pattern are displayed. It is difficult to see the after image on all colors. Once it has been corrected it will not be visible in any color.
- **White Wash:** White Wash removes ghost images from the screen. Use sparingly. Watch the TV normally for a while before using this feature to see if the ghost image disappears on its own.

NOTE

- ▶ An excessive ghosted image may be impossible to clear entirely with White Wash. To return to normal viewing, press the any button.





SOUND & LANGUAGE CONTROL

AUTO VOLUME

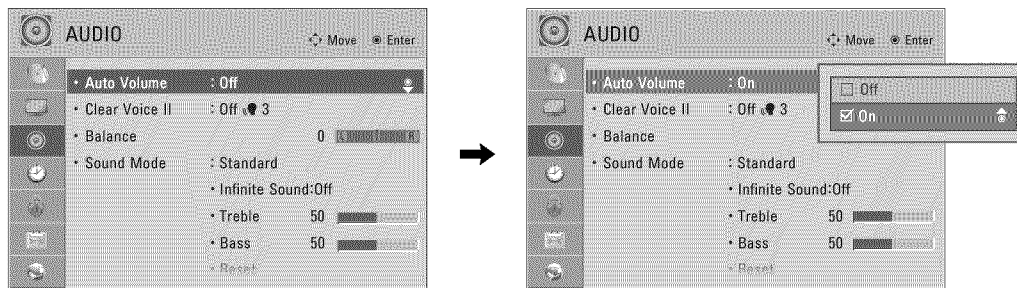
Auto Volume makes sure that the volume level remains consistent whether you are watching a commercial or a regular TV program.

Because each broadcasting station has its own signal conditions, volume adjustment may be needed every time the channel is changed. This feature allows users to enjoy stable volume levels by making automatic adjustments for each program.



-   Select **AUDIO**.
-   Select **Auto Volume**.
-   Select **On** or **Off**.
-  Return to the previous menu.
-  Return to TV viewing.

CLEAR VOICE II

By differentiating the human sound range from others, it improves the sound quality of voices.

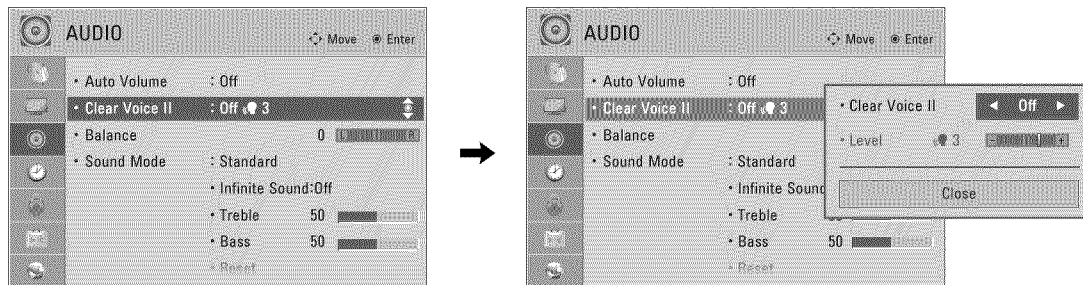

1   Select **AUDIO**.

2   Select **Clear Voice II**.

3   Select **On** or **Off**.

Adjustment for Clear Voice Level with selecting On

4  Select **Level**.

5  Make appropriate adjustments.

6  Return to the previous menu.



 Return to TV viewing.

SOUND & LANGUAGE CONTROL

BALANCE

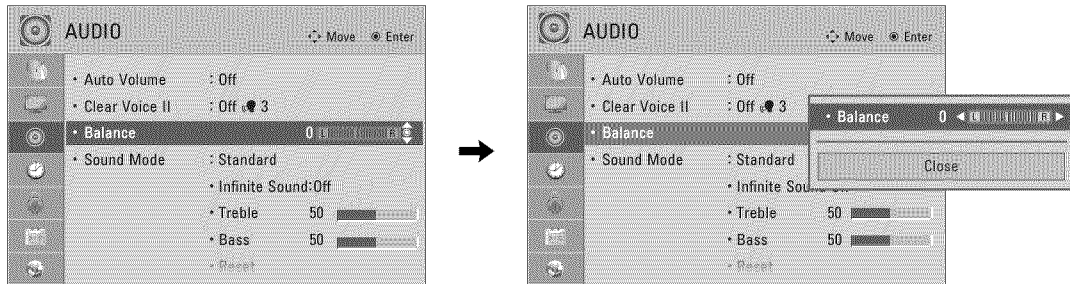
Adjust the left/right sound of speaker to suit your taste and room situations.

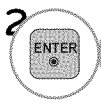
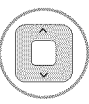
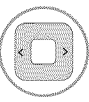







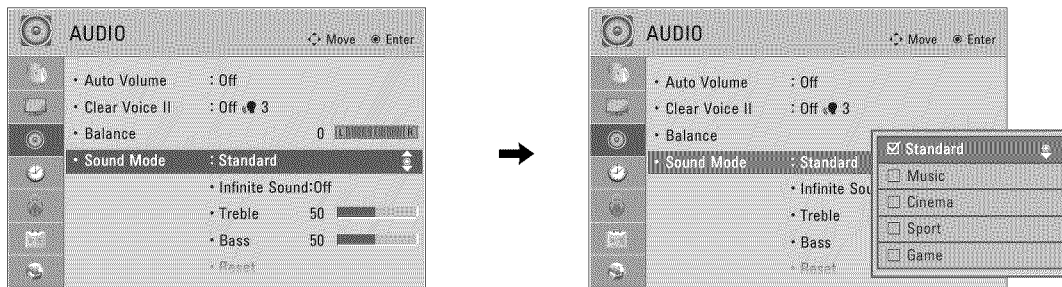

-   Select **AUDIO**.
-   Select **Balance**.
-   Make appropriate adjustments.
-  Return to the previous menu.
-  Return to TV viewing.

PRESET SOUND SETTINGS (SOUND MODE)

Sound Mode lets you enjoy the best sound without any special adjustment using factory presets.



-   Select **AUDIO**.
-   Select **Sound Mode**.
-   Select **Standard, Music, Cinema, Sport, or Game**.
-  Return to the previous menu.
-  Return to TV viewing.









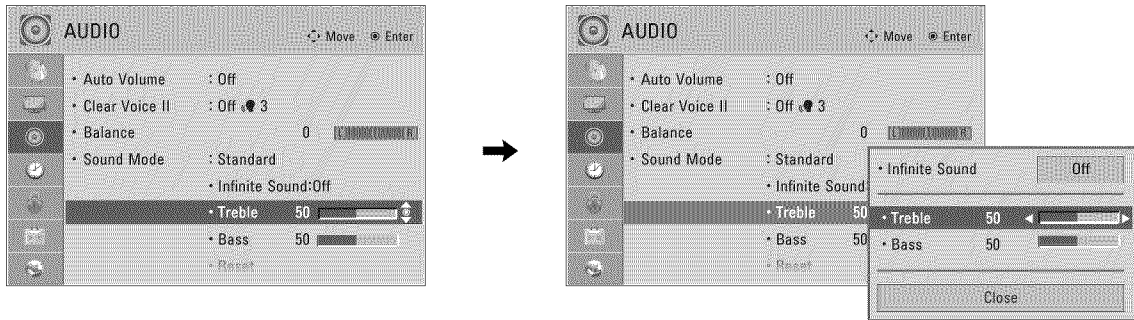



- **Standard, Music, Cinema, Sport, and Game** are preset for optimum sound quality at the factory.
- You can also adjust **Sound Mode** in the **Q.MENU**.
- **Standard**: Offers standard-quality sound.
- **Music**: Optimizes sound for listening to music.
- **Cinema**: Optimizes sound for watching movies.
- **Sport**: Optimizes sound for watching sports events.
- **Game**: Optimizes sound for playing games.

SOUND & LANGUAGE CONTROL

SOUND SETTING ADJUSTMENT - USER MODE

Adjust the sound to suit your taste and room situations.









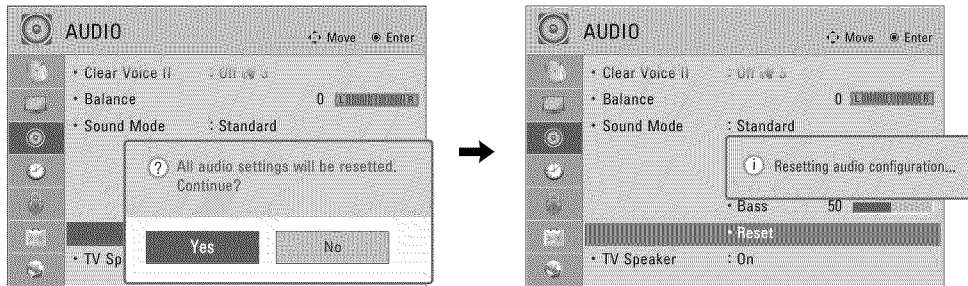

- 1   Select **AUDIO**.
- 2   Select **Sound Mode**.
- 3   Select **Standard, Music, Cinema, Sport, or Game**.
- 4   Select **Infinite Sound, Treble, or Bass**.
- 5   Make appropriate adjustments.
- 6  Return to the previous menu.
-  Return to TV viewing.

- If sound quality or volume is not at the level you want, it is recommended to use a separate home theater system or amp to cope with different user environments.
- If you select "Clear Voice II-On", the **Infinite Sound** feature will not operate.
- **Infinite Sound**: Infinite Sound is a patented LG proprietary sound processing technology that strives immersive 5.1 surround sound with just two front speakers.

AUDIO RESET

Settings of the selected Sound Mode return to the default factory settings.







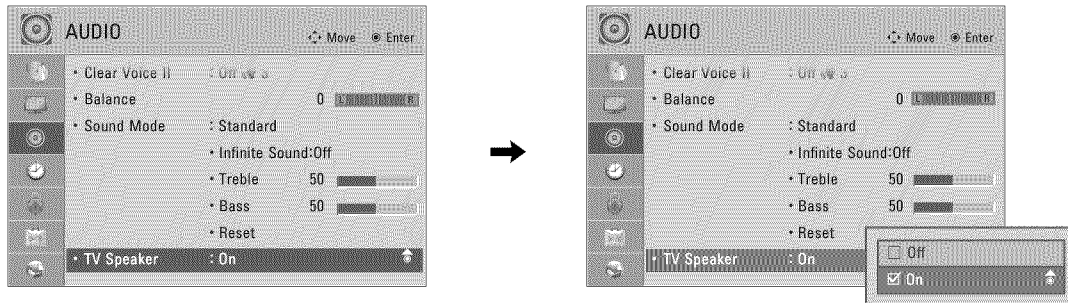

- 1   Select **AUDIO**.
- 2   Select **Reset**.
- 3   Select **Yes**.
- 4  Initialize the adjusted value.
-  Return to TV viewing.

SOUND & LANGUAGE CONTROL

TV SPEAKERS ON/OFF SETUP

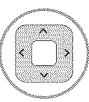
If you wish to use an external Hi-Fi system, turn off the TV's internal speakers.

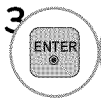
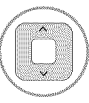



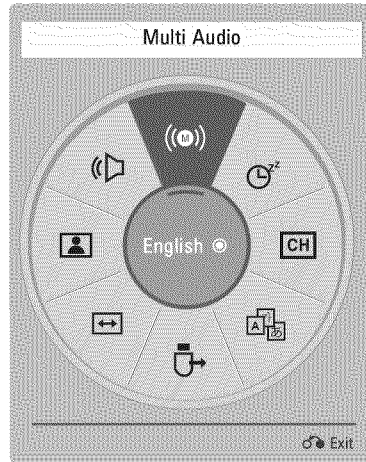

-   Select **AUDIO**.
-   Select **TV Speaker**.
-   Select **On** or **Off**.
-  Return to the previous menu.
-  Return to TV viewing.

STEREO/SAP BROADCAST SETUP





On analog signals, this TV can receive MTS stereo programs and any SAP (Secondary Audio Program) that accompanies the stereo program if the station transmits an additional sound signal. Mono sound is automatically used if the broadcast is only in Mono.



Analog TV

1.   Select **SAP**.
2.   Select **Mono, Stereo, or SAP**.
3.  Return to TV viewing.

Digital TV





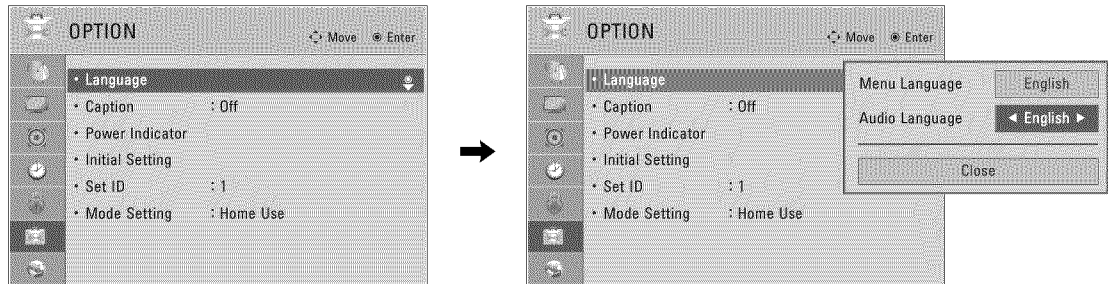

1.   Select **Multi Audio**.
2.   Select other languages.
3.  Return to TV viewing.

SOUND & LANGUAGE CONTROL

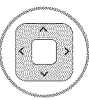
AUDIO LANGUAGE

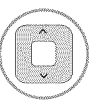
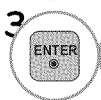
This feature operates only in DTV/Cable DTV mode.

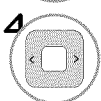







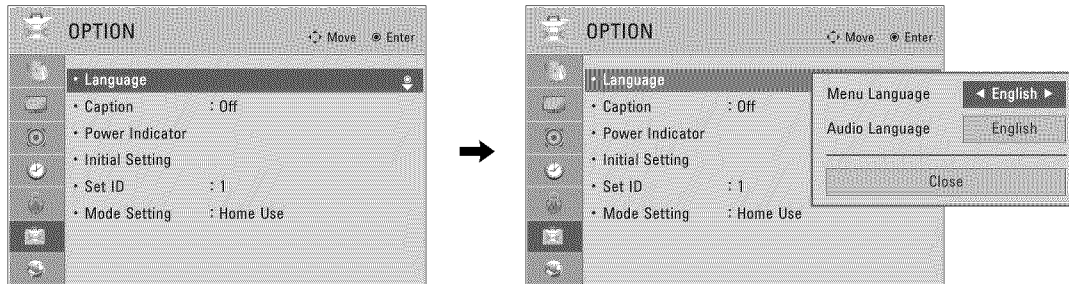

-   Select **OPTION**.
-   Select **Language**.
-   Select **Audio Language**.
-  Select your desired language.
-  Return to the previous menu.
-  Return to TV viewing.

ON-SCREEN MENUS LANGUAGE SELECTION

The menus can be shown on the screen in the selected language.



- 1   Select **OPTION**.
- 2   Select **Language**.
- 3   Select **Menu Language**.
- 4  Select your desired language.
From this point on, the on-screen menus will be shown in the selected language.
- 5  Return to the previous menu.
-  Return to TV viewing.







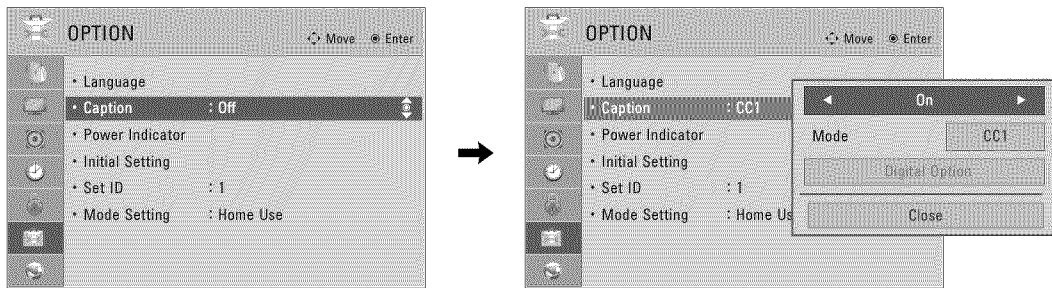

SOUND & LANGUAGE CONTROL

CAPTION MODE

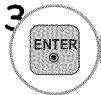
Analog Broadcasting System Captions

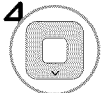
Captions are provided to help the hearing impaired watch TV. Select a caption mode for displaying captioning information if provided on a program. Analog caption displays information at any position on the screen and is usually the program's dialog. Caption/Text, if provided by the broadcaster, would be available for both digital and analog channels on the Antenna/Cable. This TV is programmed to memorize the caption/text mode which was last set when you turned the power off. This function is only available when **Caption Mode** is set **On**.



- 1   Select **OPTION**.
- 2   Select **Caption**.
- 3   Select **On**.
- 4   Select **CC1-4** or **Text1-4**.
- 5  Return to the previous menu.
-  Return to TV viewing.

- When selecting **Off**, Sub-menus for Analog, DTV, and Digital Option become disabled.

■ **Caption**

The term for the words that scroll across the bottom of the TV screen; usually the audio portion of the program provided for the hearing impaired.

■ **Text**

The term for the words that appear in a large black frame and almost cover the entire screen; usually messages provided by the broadcaster.









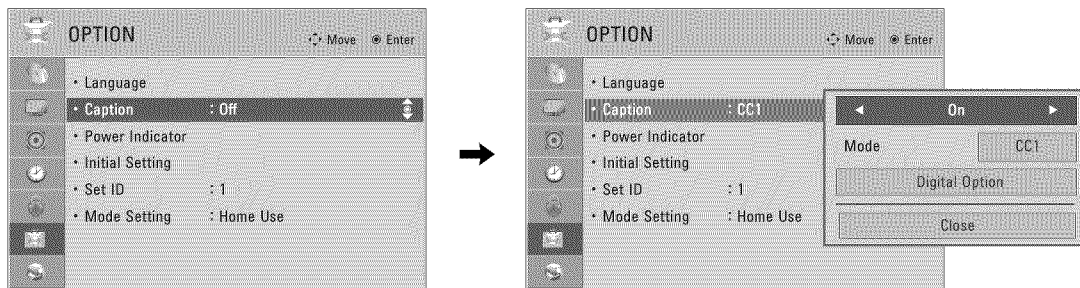

Digital Broadcasting System Captions

Choose the language you want the DTV/Cable DTV Captions to appear in.

Other Languages can be chosen for digital sources only if they are included on the program.

This function is only available when **Caption Mode** is set **On**.



- 1   Select **OPTION**.
- 2   Select **Caption**.
- 3   Select **On**.
- 4   Select **CC1-4, Text1-4, or Service1 - 6**.
- 5  Return to the previous menu.
-  Return to TV viewing.

SOUND & LANGUAGE CONTROL

Caption Option

Customize the DTV/Cable DTV captions that appear on your screen.

This function is only available when **Caption Mode** is set **On**.

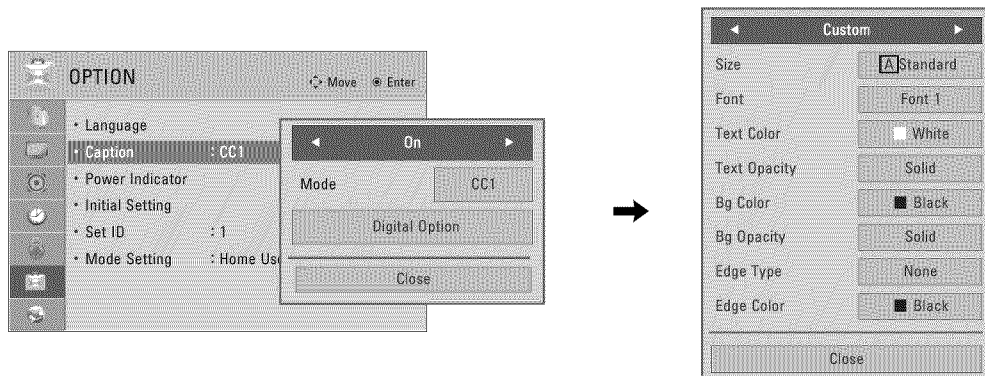

1 Select **OPTION**.

2 Select **Caption**.

3 Select **On**.

4 Select **Digital Option**.

5 Select **Custom**.

6 Customize the **Size**, **Font**, etc., to your preference. A preview icon is provided at the bottom of the screen, use it to see the caption language.

7 Return to the previous menu.

Return to TV viewing.

- **Size:** Set the word size.
- **Font:** Select a typeface for the text.
- **Text Color:** Choose a color for the text.
- **Text Opacity:** Specify the opacity for the text color.
- **Bg (Background) Color:** Select a background color.
- **Bg (Background) Opacity:** Select the opacity for the background color.
- **Edge Type:** Select an edge type.
- **Edge Color:** Select a color for the edges.

TIME SETTING

CLOCK SETTING









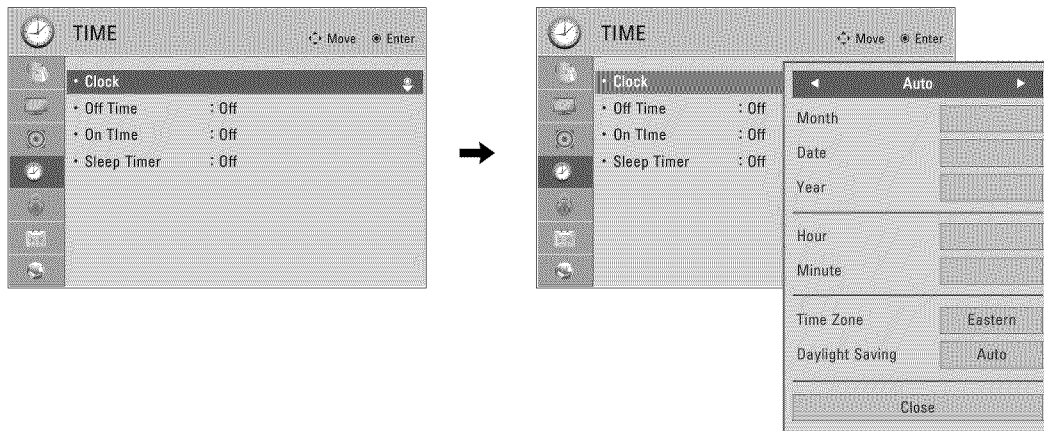

Auto Clock Setup

The time is set automatically from a digital channel signal.

The digital channel signal includes information for the current time provided by the broadcasting station.

Set the clock manually if the current time is set incorrectly by the auto clock function.











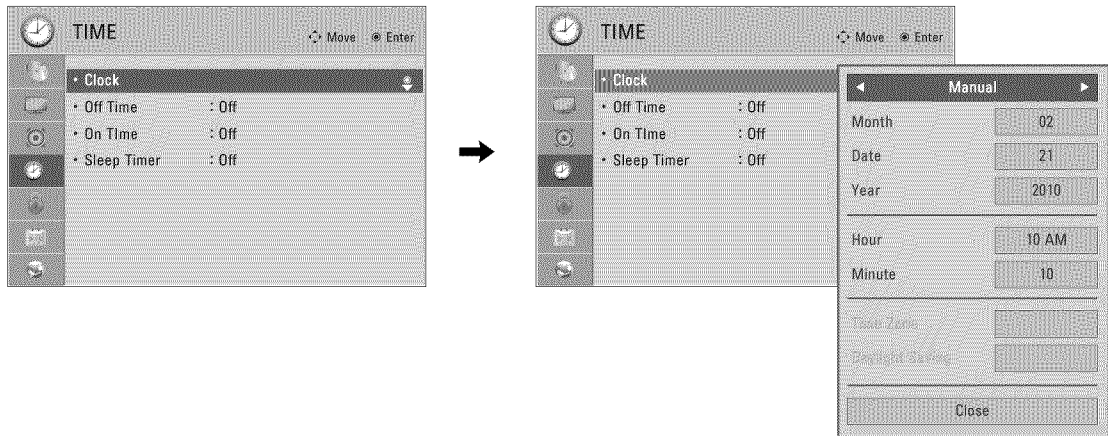

- 1   Select **TIME**.
- 2   Select **Clock**.
- 3   Select **Auto**.
- 4   Select your viewing area time zone.
USA: **Eastern, Central, Mountain, Pacific, Alaska, or Hawaii.**
Canada: **Eastern, Central, Mountain, Pacific, New Foundland, or Atlantic.**
- 5   Select **Auto, Off, or On** (depending on whether or not your viewing area observes Daylight Saving time).
- 6  Return to the previous menu.
-  Return to TV viewing.

TIME SETTING

Manual Clock Setup

If the current time setting is wrong, reset the clock manually.



-   Select **TIME**.
-   Select **Clock**.
-   Select **Manual**.
-  Select the Year, Month, Date, Hour, or Minute option.
-  Set the Year, Month, Date, Hour, or Minute option.
-  Return to the previous menu.
-  Return to TV viewing.

AUTO ON/OFF TIME SETTING

This function operates only if the current time has been set.

The **Off Time** function overrides the **On Time** function if they are both set to the same time.

The TV must be in standby mode for the **On Time** to work.

If you do not press any button within 2 hours after the TV turns on with the **On Time** function, the TV will automatically revert to standby mode.

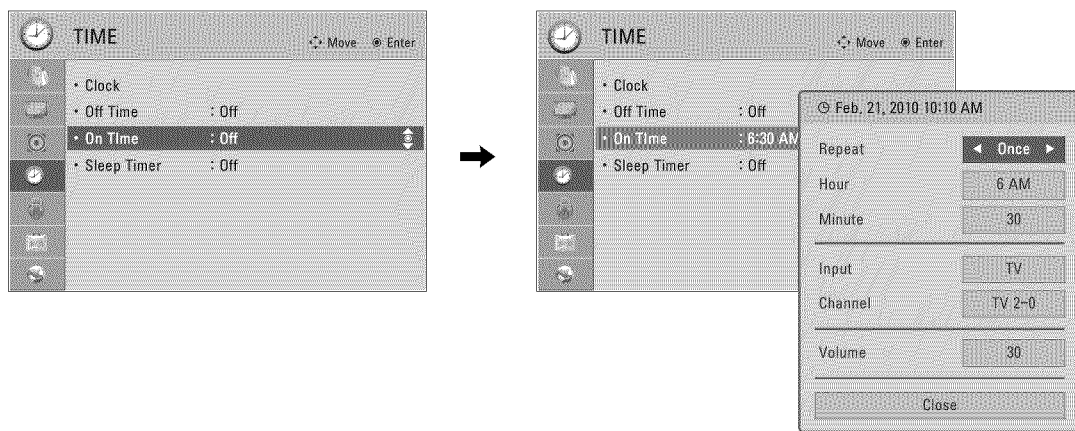

- 1 Select **TIME**.
- 2 Select **Off Time** or **On Time**.
- 3 Select **Repeat**.
- 4 Select **Off**, **Once**, **Daily**, **Mon.~Fri.**, **Mon.~Sat.**, **Sat.~ Sun.**, or **Sun.**.
- 5 Select and set Hour or Minute.
- 6 Return to the previous menu.
- Return to TV viewing.

- To cancel **On/Off Time** function, select **Off**.

- Only for **On Time** function

- 1 Select **Input**.
- 2 Select the desired input source.
- 3 When Selecting **TV**: set the channel at turn-on.
- 4 Adjust to sound level at turn-on.





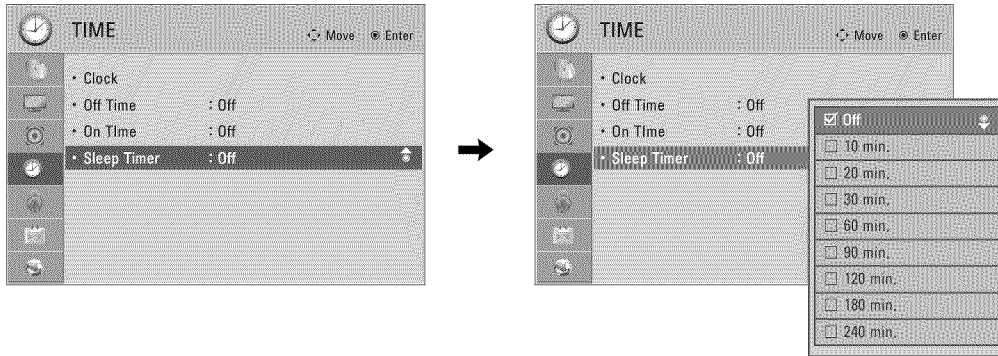

TIME SETTING

SLEEP TIMER SETTING

The Sleep Timer turns the TV off at the preset time.

Note that this setting is cleared when the TV is turned off.



-   Select **TIME**.
-   Select **Sleep Timer**.
-   Make appropriate adjustments.
-  Return to the previous menu.
-  Return to TV viewing.

- To cancel the **Sleep Timer**, select **Off**.
- You can also adjust **Sleep Timer** in the **Q.MENU**.

PARENTAL CONTROL / RATINGS

Parental Control can be used to block specific channels, ratings and other viewing sources.

The Parental Control Function (V-Chip) is used to block program viewing based on the ratings sent by the broadcasting station. The default setting is to allow all programs to be viewed. Viewing can be blocked by choosing the type of the program and the categories. It is also possible to block all program viewing for a time period. To use this function, the following must be done :

1. Set ratings and categories to be blocked.
2. Specify a password
3. Enable the lock

V-Chip rating and categories

Rating guidelines are provided by broadcasting stations. Most television programs and television movies can be blocked by TV Rating and/or Individual Categories. Movies that have been shown at the theaters or direct-to-video movies use the Movie Rating System (MPAA) only.

Ratings for Television programs including made-for-TV movies:

- TV-G (General audience)
- TV-PG (Parental guidance suggested)
- TV-14 (Parents strongly cautioned)
- TV-MA (Mature audience only)
- TV-Y (All children)
- TV-Y7 (Children 7 years older)

SET PASSWORD & LOCK SYSTEM

Setting up Your Password

Set up blocking schemes to block specific channels, ratings, and external viewing sources.



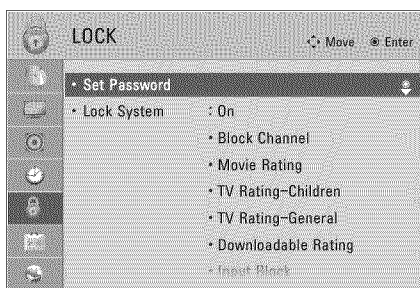

A password is required to gain access to this menu.

For USA

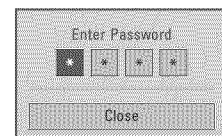
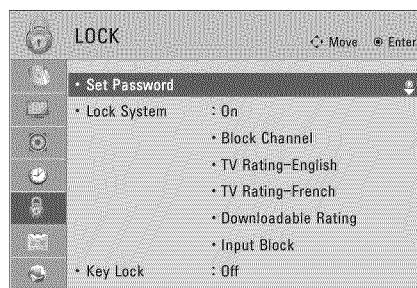

For Canada



1.    Select **LOCK**.
2.  Input the password.



- Enter the password as requested.
- The TV is set up with the initial password "0-0-0-0".
- If you forget your password, press "0-3-2-5" on the remote control.

PARENTAL CONTROL / RATINGS

Set Password

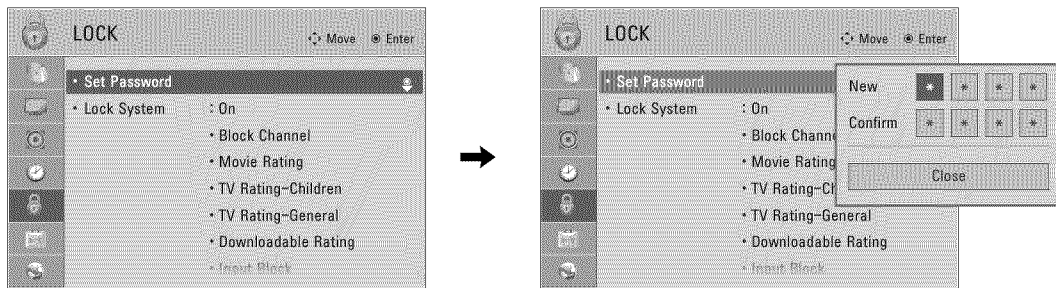

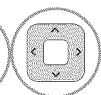
Change the password by inputting a new password twice.





1    Select **LOCK**.

2  Input the password.

3  Select **Set Password**.

4   Choose any 4 digits for your new password.
As soon as the 4 digits are entered, re-enter the same 4 digits on the **Confirm**.



5  Return to the previous menu.

 Return to TV viewing.

Lock System

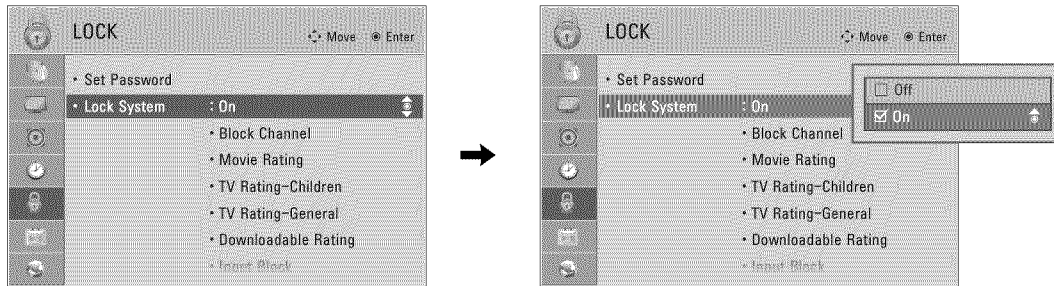
Enables or disables the blocking scheme you set up previously.





1    Select **LOCK**.

2  Input the password.

3  Select **Lock System**.

4   Select **On** or **Off**.

5  Return to the previous menu.

 Return to TV viewing.



■ When you select **On**, the Lock System is enable.

PARENTAL CONTROL / RATINGS

CHANNEL BLOCKING

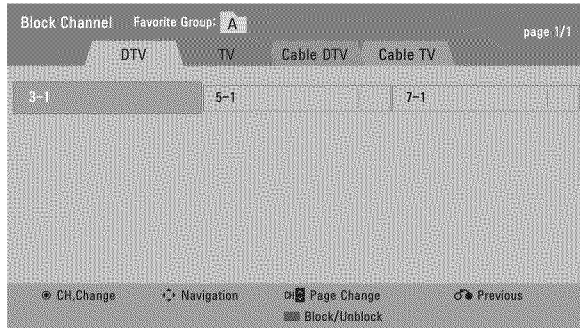
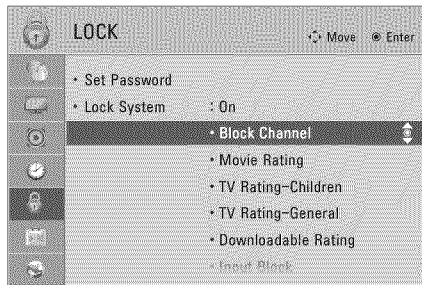
Blocks any channels that you do not want to watch or that you do not want your children to watch.

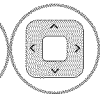



1    Select **LOCK**.

2  Input the password.

3  Select **Block Channel**.

4   Select a channel to block or unblock.

5  Block or unblock a channel.

6  Return to the previous menu.

 Return to TV viewing.

■ If a channel is locked, enter the password to unlock it temporarily.

MOVIE & TV RATING

Movie Rating (MPAA)- For USA

Blocks movies according to the movie ratings limits specified, so children cannot view certain movies. You can set the ratings limit by blocking out all the movies with the ratings above a specified level. Keep in mind that the movie ratings limit only applies to movies shown on TV, not TV programs, such as soap operas.

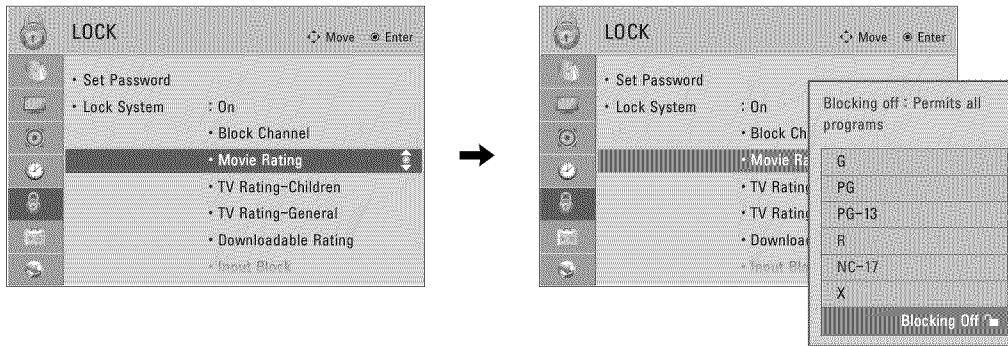

- 1 Select **LOCK**.
- 2 Input the password.
- 3 Select **Movie Rating**.
- 4 Select **G, PG, PG-13, R, NC-17, X, or Blocking Off**.
- 5 Return to the previous menu.
- Return to TV viewing.



- If **Movie Rating, TV Rating-Children** or **TV Rating-General** is locked, enter the password to unlock it temporarily.
- **G** (General audience)
- **PG** (Parental guidance suggested)
- **PG-13** (Parents strongly cautioned)
- **R** (Restricted)
- **NC-17** (No one 17 and under admitted)
- **X** (Adult only)
- **Blocking Off** (Permits all programs)
- If you set PG-13: G and PG movies will be available, PG-13, R, NC-17 and X will be blocked.

PARENTAL CONTROL / RATINGS

TV Rating Children - For USA

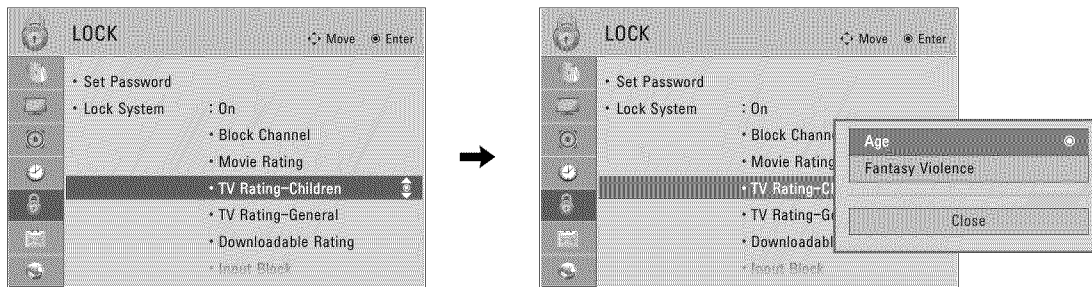
Prevents children from watching certain children's TV programs, according to the ratings limit set. The children rating does not apply to other TV programs. Unless you block certain TV programs intended for mature audiences in the TV Rating - sub menu, your children can view those programs.

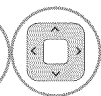

1    Select **LOCK**.

2  Input the password.

3  Select **TV Rating-Children**.

4   Select **Age** or **Fantasy Violence**.

5   Select block options.

6  Return to the previous menu.









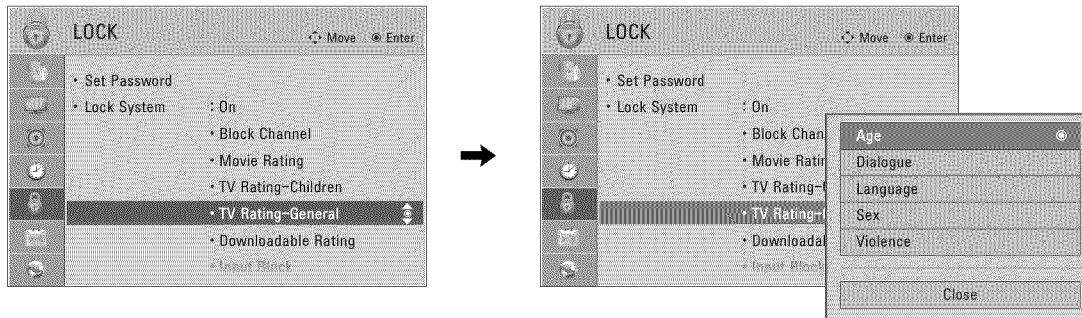

 Return to TV viewing.

- **Age** (applies to TV-Y, TV-Y7)
- **Fantasy Violence** (applies to TV-Y7)

TV Rating General - For USA

Based on the ratings, blocks certain TV programs that you and your family do not want to view.



- 1    Select **LOCK**.
- 2  Input the password.
- 3  Select **TV Rating-General**.
- 4   Select **Age, Dialogue, Language, Sex** or **Violence**.
- 5   Select block options.
- 6  Return to the previous menu.
-  Return to TV viewing.







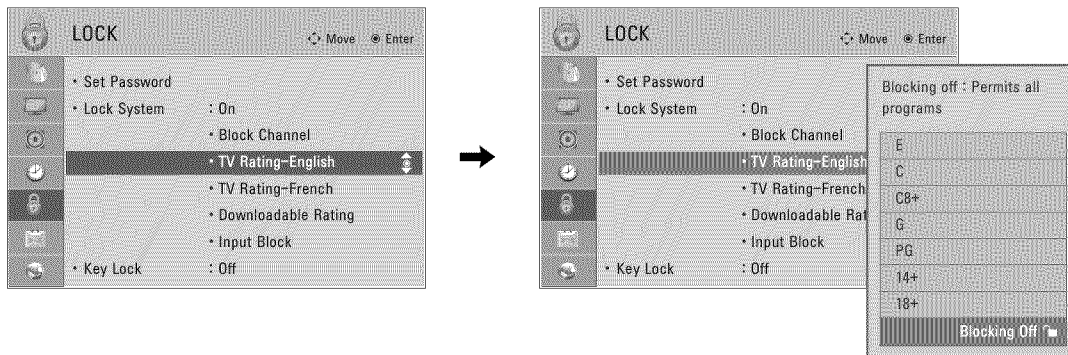

- **Age** (applies to TV-G,TV-PG,TV-14,TV-MA).
- **Dialogue**-sexual dialogue (applies to TV-PG,TV-14).
- **Language**-adult language (applies to TV-PG, TV-14, TV-MA).
- **Sex**-sexual situations (applies to TV-PG, TV-14, TV-MA).
- **Violence** (applies to TV-PG, TV-14, TV-MA).

PARENTAL CONTROL / RATINGS

TV Rating English - For CANADA

Selecting Canadian English rating system.











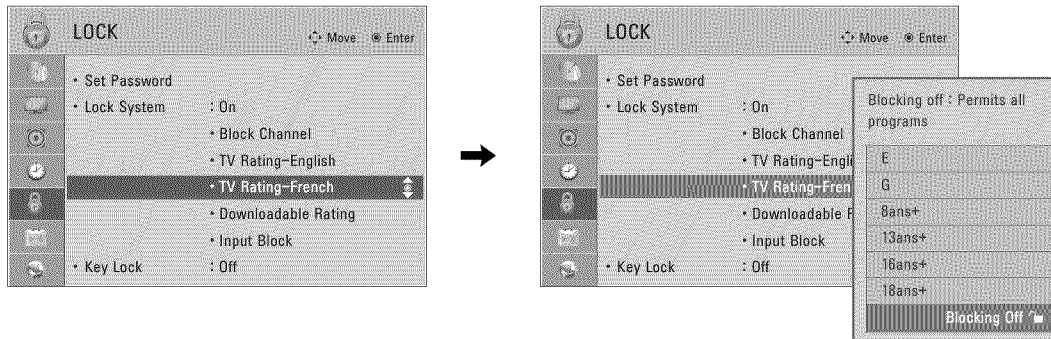

1.    Select **LOCK**.
2.  Input the password.
3.  Select **TV Rating-English**.
4.   Select **E, C, C8+, G, PG, 14+, 18+, or Blocking Off**.
5.  Return to the previous menu.
-  Return to TV viewing.

- If TV Rating-English or TV Rating-French is locked, enter the password to unlock it temporarily.
- **E** (Exempt)
- **C** (Children)
- **C8+** (Children eight years and older)
- **G** (General programming, suitable for all audiences)
- **PG** (Parental Guidance)
- **14+** (Viewers 14 years and older)
- **18+** (Adult programming)
- **Blocking Off** (Permits all programs)

TV Rating French - For CANADA

Selecting Canadian French rating system.



- 1    Select **LOCK**.
- 2  Input the password.
- 3  Select **TV Rating-French**.
- 4   Select **E, G, 8ans+, 13ans+, 16ans+, 18ans+, or Blocking Off**.
- 5  Return to the previous menu.
-  Return to TV viewing.

- **E** (Exempt)
- **G** (General)
- **8ans+** (General-Not convenient for little children)
- **13ans+** (Not convenient for children of 13 years and younger)
- **16ans+** (Not convenient for children of 16 years and younger)
- **18ans+** (This programs is only for adults)
- **Blocking Off** (Permits all programs)

PARENTAL CONTROL / RATINGS





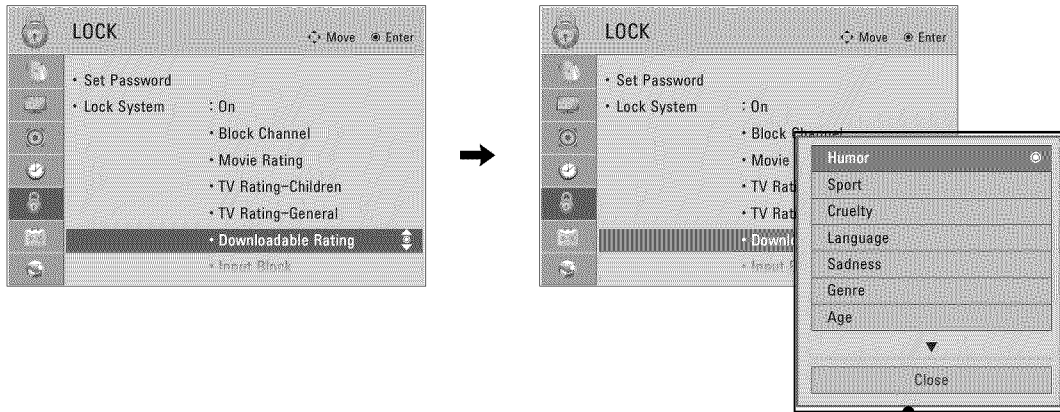

DOWNLOADABLE RATING

This function is available only for digital channels.

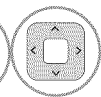
This function operates only when TV has received Region5 Rating data.

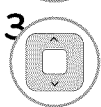
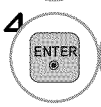
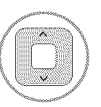

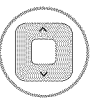
■ Based on rating table, your TV's OSD (On Screen Display) may differ slightly from what is shown in this manual.

- 1    Select **LOCK**.
- 2  Input the password.
- 3  Select **Downloadable Rating**.
- 4   Select desired **Downloadable Rating** option.
- 5   Select desired option and block it.
- 6  Return to the previous menu.
-  Return to TV viewing.

■ If a Downloadable rating is locked, enter the password to unlock it temporarily.

EXTERNAL INPUT BLOCKING

Enables you to block an input.

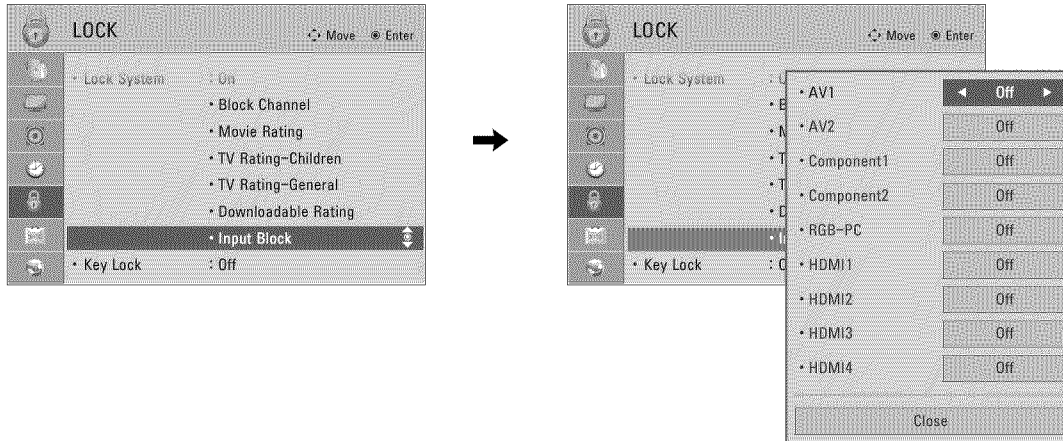

1 Select **LOCK**.

2 Input the password.

3 Select **Input Block**.

4 Select input source.

5 Select **On** or **Off**.

6 Return to the previous menu.

Return to TV viewing.

PARENTAL CONTROL / RATINGS

KEY LOCK

This feature can be used to prevent unauthorized viewing by locking out the front panel controls, so that it can only be used with the remote control.

This TV is programmed to remember which option it was last set to even if you turn the TV off.

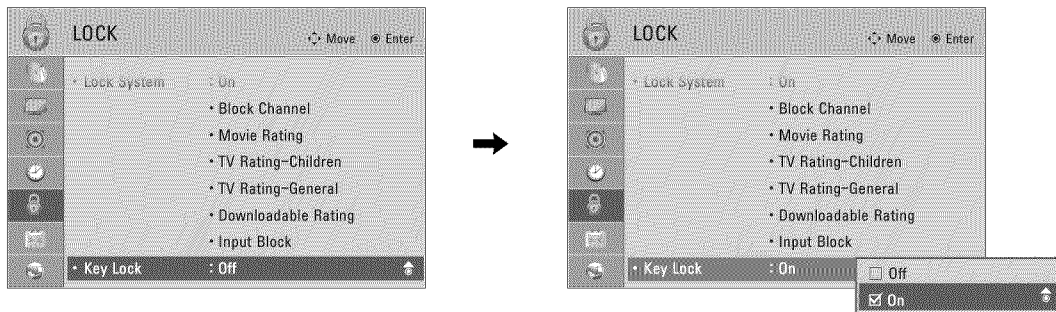

1 Select **LOCK**.

2 Input the password.

3 Select **Key Lock**.

4 Select **On** or **Off**.

5 Return to the previous menu.

Return to TV viewing.

- In Key Lock 'On', if the TV is turned off, press the / I, INPUT, CH (or) button on the TV or POWER, INPUT, CH () or NUMBER buttons on the remote control.
- With the **Key Lock On**, the display ' **Key Lock**' appears on the screen if any button on the front panel is pressed while viewing the TV.

APPENDIX

TROUBLESHOOTING

Abnormal Operation	
The remote control doesn't work	<ul style="list-style-type: none"> ■ Check to see if there is any object between the product and the remote control causing obstruction. Ensure you are pointing the remote control directly at the TV. ■ Ensure that the batteries are installed with correct polarity (+ to +, - to -). ■ Ensure that the correct remote operating mode is set: TV, VCR etc. ■ Install new batteries. *This feature is not available for all models.
TV turns off suddenly	<ul style="list-style-type: none"> ■ Is the sleep timer set? ■ Check the power control settings. Power interrupted. ■ If there is no signal, the TV turns off automatically in 15 minutes.

Video Problems	
No picture & No sound	<ul style="list-style-type: none"> ■ Check whether the product is turned on. ■ Try another channel. The problem may be with the broadcast. ■ Is the power cord inserted into wall power outlet? ■ Check your antenna direction and/or location. ■ Test the wall power outlet, plug another product's power cord into the outlet where the product's power cord was plugged in.
Picture appears slowly after switching on	<ul style="list-style-type: none"> ■ This is normal, the image is muted during the product startup process. Please contact your service center, if the picture has not appeared after five minutes.
No or poor color or poor picture	<ul style="list-style-type: none"> ■ Adjust Color in menu option. ■ Keep a sufficient distance between the product and the VCR. ■ Try another channel. The problem may be with the broadcast. ■ Are the video cables installed properly? ■ Activate any function to restore the brightness of the picture.
Horizontal/vertical bars or picture shaking	<ul style="list-style-type: none"> ■ Check for local interference such as an electrical appliance or power tool.
Poor reception on some channels	<ul style="list-style-type: none"> ■ Station or cable product experiencing problems, tune to another station. ■ Station signal is weak, reorient antenna to receive weaker station. ■ Check for sources of possible interference.
Lines or streaks in pictures	<ul style="list-style-type: none"> ■ Check antenna (Change the direction of the antenna).
No picture when connecting HDMI	<ul style="list-style-type: none"> ■ If an HDMI cable doesn't support High Speed HDMI, it can cause flickers or no screen display. In this case use the latest cables that support High Speed HDMI.

APPENDIX

Audio Problems	
No output from one of the speakers	<ul style="list-style-type: none"> ■ Adjust Balance in menu option.
Unusual sound from inside the product	<ul style="list-style-type: none"> ■ A change in ambient humidity or temperature may result in an unusual noise when the product is turned on or off and does not indicate a fault with the product.
No sound when connecting HDMI/USB	<ul style="list-style-type: none"> ■ Check High Speed HDMI cable. ■ Check USB cable over version 2.0. ■ Use normal MP3 file. *This feature is not available for all models.

PC Mode Problems	
The signal is out of range	<ul style="list-style-type: none"> ■ Adjust resolution, horizontal frequency, or vertical frequency on the PC. ■ Check the input source.
Vertical bar or stripe on background & Horizontal Noise & Incorrect position	<ul style="list-style-type: none"> ■ Activate the Auto configure feature or adjust size, phase, or H/V position. (Option)
Screen color is unstable or single color	<ul style="list-style-type: none"> ■ Check the signal cable. ■ Reinstall the PC video card.
When connecting the HDMI cable to the PC, there is no audio.	<ul style="list-style-type: none"> ■ Check the manual for the video card in the PC to see if it supports HDMI audio and how to set it up properly.

Movie List Problems	
The file does not appear on the Movie List.	<ul style="list-style-type: none"> ■ Check whether the file extension is supported.
Message is displayed saying "This file is invalid" or the audio is working normally but the video is not working normally.	<ul style="list-style-type: none"> ■ Check whether the file is playing normally on a PC. (Check whether the file is damaged.) ■ Check whether the resolution is supported. ■ Check whether the video/audio codec is supported. ■ Check whether the frame rate is supported.
Message is displayed saying "Unsupported Audio" or the video is working normally but the audio is not working normally.	<ul style="list-style-type: none"> ■ Check whether the file is playing normally on a PC. (Check whether the file is damaged.) ■ Check whether the audio codec is supported. ■ Check whether the bit rate is supported. ■ Check whether the sample rate is supported.
Subtitle is not working.	<ul style="list-style-type: none"> ■ Check whether the file is playing normally on a PC. (Check whether the file is damaged.) ■ Check whether the video file and subtitle file name are the same. ■ Check whether the video file and subtitle file are located in the same folder. ■ Check whether the subtitle file is supported. ■ Check whether the language is supported. (When you open the subtitle file on a PC, you can check the language of the subtitle file.)

APPENDIX

MAINTENANCE

Early malfunctions can be prevented. Careful and regular cleaning can extend the amount of time you can enjoy your new TV.

Caution: Be sure to turn the power off and unplug the power cord before you begin any cleaning.

Cleaning the Screen

- 1 Here's a great way to keep the dust off your screen for a while. Wet a soft cloth in a mixture of lukewarm water and a little fabric softener or dish washing detergent. Wring the cloth until it's almost dry, and then use it to wipe the screen.
- 2 Make sure the excess water is off the screen, and then let it air-dry before you turn on your TV.

Cleaning the Cabinet

- To remove dirt or dust, wipe the cabinet with a soft, dry, lint-free cloth.
- Please be sure not to use a wet cloth.

Extended Absence

CAUTION

- ▶ If you expect to leave your TV dormant for a long time (such as a vacation), it's a good idea to unplug the power cord to protect against possible damage from lightning or power surges.

PRODUCT SPECIFICATIONS

MODELS		47LX9500 (47LX9500-UA)	55LX9500 (55LX9500-UA)
Dimensions (Width x Height x Depth)	With stand	1085.9 mm x 710.6 mm x 255.0 mm (42.7 inch x 27.9 inch x 10.0 inch)	1255.8 mm x 805.0 mm x 255.0 mm (49.4 inch x 31.6 inch x 10.0 inch)
	Without stand	1085.9 mm x 654.2 mm x 31.6 mm (42.7 inch x 25.7 inch x 1.2 inch)	1255.8 mm x 749.6 mm x 31.6 mm (49.4 inch x 29.5 inch x 1.2 inch)
Weight	With stand	26.7 kg (58.8 lbs)	32.7 kg (72.0 lbs)
	Without stand	22.1 kg (48.7 lbs)	28.1 kg (61.9 lbs)

Power requirement	AC 120 V ~ 50 / 60 Hz	
Television System	NTSC-M, ATSC, 64 & 256 QAM	
Program Coverage	VHF 2-13, UHF 14-69, CATV 1-135, DTV 2-69, CADTV 1-135	
External Antenna Impedance	75 Ω	
Environment condition	Operating Temperature	0 °C to 40 °C (32 °F to 104 °F)
	Operating Humidity	Less than 80 %
	Storage Temperature	-20 °C to 60 °C (-4 °F to 140 °F)
	Storage Humidity	Less than 85 %

■ The specifications shown above may be changed without prior notice for quality improvement.

APPENDIX

MODELS		47LEX8 (47LEX8-UA)	55LEX8 (55LEX8-UA)
Dimensions (Width x Height x Depth)	With stand	1126.6 mm x 757.9 mm x 284.4 mm (44.3 inch x 29.8 inch x 11.1 inch)	1306.0 mm x 867.0 mm x 345.0 mm (51.4 inch x 34.1 inch x 13.5 inch)
	Without stand	1126.6 mm x 692.0 mm x 29.3 mm (44.3 inch x 27.2 inch x 1.1 inch)	1306.0 mm x 797.0 mm x 30.7 mm (51.4 inch x 31.3 inch x 1.2 inch)
Weight	With stand	22.9 kg (50.4 lbs)	34.5 kg (76.0 lbs)
	Without stand	19.6 kg (43.2 lbs)	28.8 kg (63.4 lbs)

MODELS		60LEX9 (60LEX9-UA)	72LEX9 (72LEX9-UA)
Dimensions (Width x Height x Depth)	With stand	1126.6 mm x 757.9 mm x 284.4 mm (44.3 inch x 29.8 inch x 11.1 inch)	1306.0 mm x 867.0 mm x 345.0 mm (51.4 inch x 34.1 inch x 13.5 inch)
	Without stand	1126.6 mm x 692.0 mm x 29.3 mm (44.3 inch x 27.2 inch x 1.1 inch)	1306.0 mm x 797.0 mm x 30.7 mm (51.4 inch x 31.3 inch x 1.2 inch)
Weight	With stand	22.9 kg (50.4 lbs)	34.5 kg (76.0 lbs)
	Without stand	19.6 kg (43.2 lbs)	28.8 kg (63.4 lbs)

Power requirement	AC 120 V ~ 50 / 60 Hz	
Television System	NTSC-M, ATSC, 64 & 256 QAM	
Program Coverage	VHF 2-13, UHF 14-69, CATV 1-135, DTV 2-69, CADTV 1-135	
External Antenna Impedance	75 Ω	
Environment condition	Operating Temperature	0 °C to 40 °C (32 °F to 104 °F)
	Operating Humidity	Less than 80 %
	Storage Temperature	-20 °C to 60 °C (-4 °F to 140 °F)
	Storage Humidity	Less than 85 %

■ The specifications shown above may be changed without prior notice for quality improvement.

MODELS		50PK950 (50PK950-UA, 50PK950-UF)	60PK950 (60PK950-UA, 60PK950-UF)
Dimensions (Width x Height x Depth)	With stand	1190.0 mm x 804.5 mm x 294.5 mm (46.8 inch x 31.6 inch x 11.5 inch)	1408.8 mm x 937.9 mm x 384.0 mm (55.4 inch x 36.9 inch x 15.1 inch)
	Without stand	1190.0 mm x 737.0 mm x 52.4 mm (46.1 inch x 29.0 inch x 2.0 inch)	1408.8 mm x 860.7 mm x 52.4 mm (55.4 inch x 33.8 inch x 2.0 inch)
Weight	With stand	34.8 kg (76.7 lbs)	50.9 kg (112.2 lbs)
	Without stand	30.2 kg (66.5 lbs)	43.3 kg (95.4 lbs)

Power requirement	AC 100-240 V ~ 50 / 60 Hz	
Television System	NTSC-M, ATSC, 64 & 256 QAM	
Program Coverage	VHF 2-13, UHF 14-69, CATV 1-135, DTV 2-69, CADTV 1-135	
External Antenna Impedance	75 Ω	
Environment condition	Operating Temperature	0 °C to 40 °C (32 °F to 104 °F)
	Operating Humidity	Less than 80 %
	Storage Temperature	-20 °C to 60 °C (-4 °F to 140 °F)
	Storage Humidity	Less than 85 %

■ The specifications shown above may be changed without prior notice for quality improvement.

APPENDIX

IR CODES

*This feature is not available for all models.

1. How to Connect

- Connect your wired remote control to the Remote Control port on the TV.

2. Remote Control IR Codes

■ Output waveform

Single pulse, modulated with 37.917 KHz signal at 455 KHz

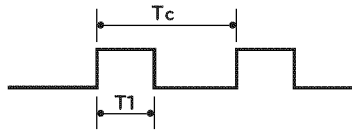

Carrier frequency
 $FCAR = 1/TC = fOSC/12$
 Duty ratio = $T1/TC = 1/3$

■ Configuration of frame

1st frame

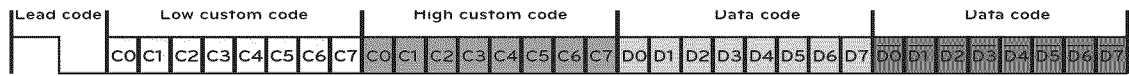

Repeat frame

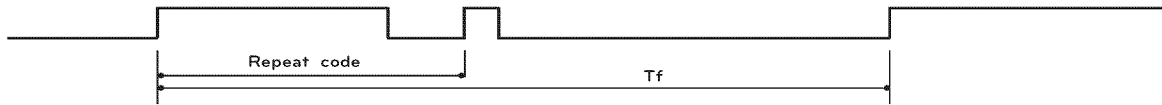

■ Lead code

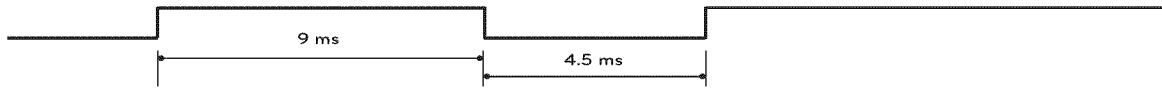

■ Repeat code

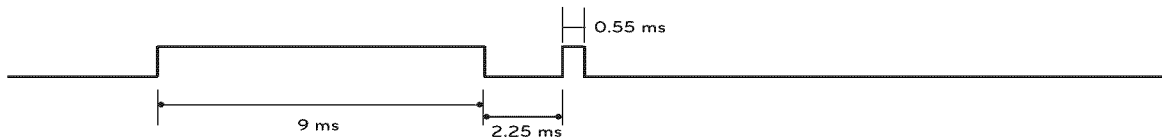

■ Bit description: Tf

Bit "0"

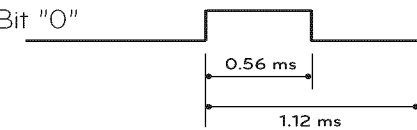

Bit "1"

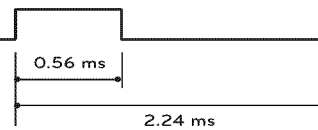

■ Frame interval: Tf

The waveform is transmitted as long as a key is depressed.

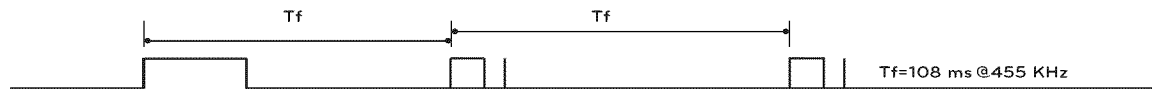

Code (Hexa)	Function	Note	Code (Hexa)	Function	Note
00	CH ^	Remote Control Button	B0	▶	Remote Control Button
01	CH v	Remote Control Button	B1	■	Remote Control Button
02	VOL +	Remote Control Button	BA		Remote Control Button
03	VOL -	Remote Control Button	D6	TV	Discrete IR Code (TV Input Selection)
06	>	Remote Control Button	C4	POWER ON	Discrete IR Code (Only Power On)
07	<	Remote Control Button	C5	POWER OFF	Discrete IR Code (Only Power Off)
08	⏻	Remote Control Button (Power On/Off)	5A	AV1	Discrete IR Code (AV1 Input Selection)
09	MUTE/DELETE	Remote Control Button	D0	AV2	Discrete IR Code (AV2 Input Selection)
0B	INPUT	Remote Control Button	BF	COMPONENT1	Discrete IR Code (Component1 Input Selection)
0F	TV	Remote Control Button	D4	COMPONENT2	Discrete IR Code (Component2 Input Selection)
10-19	Number 0-9	Remote Control Button	D5	RGB-PC	Discrete IR Code (RGB-PC Input Selection)
1A	FLASHBK	Remote Control Button	CE	HDMI1	Discrete IR Code (HDMI1 Input Selection)
1E	FAV/MARK	Remote Control Button	CC	HDMI2	Discrete IR Code (HDMI2 Input Selection)
28	BACK	Remote Control Button	E9	HDMI3	Discrete IR Code (HDMI3 Input Selection)
30	AV MODE	Remote Control Button	DA	HDMI4	Discrete IR Code (HDMI4 Input Selection)
40	^	Remote Control Button	76	Ratio 4:3	Discrete IR Code (Only 4:3 Mode)
41	v	Remote Control Button	77	Ratio 16:9	Discrete IR Code (Only 16:9 Mode)
43	MENU	Remote Control Button	AF	Ratio Zoom	Discrete IR Code (Only Zoom Mode)
44	ENTER	Remote Control Button	DC	3D	Remote Control Button
45	Q.MENU	Remote Control Button			
4C	- (Dash)/LIST	Remote Control Button			
5B	EXIT	Remote Control Button			
58	WIDGETS	Remote Control Button			
59	NETCAST	Remote Control Button			
61	BLUE/(L/R SELECT)	Remote Control Button			
63	YELLOW	Remote Control Button			
71	GREEN	Remote Control Button			
72	RED	Remote Control Button			
79	RATIO	Remote Control Button			
7E	SIMPLINK	Remote Control Button			
8E	▶▶	Remote Control Button			
8F	◀◀	Remote Control Button			
95	ENERGY SAVING	Remote Control Button			
AA	INFO	Remote Control Button			

■ Use this feature depending on your models.

APPENDIX

EXTERNAL CONTROL THROUGH RS-232C

The RS-232C port allows you connect the RS-232C input jack to an external control device (such as a computer or an A/V control system) to control the TV's functions externally.

■ Note: RS-232C on this unit is intended to be used with third party RS-232C control hardware and software.

The instructions below are provided to help with programming software or to test functionality using telenet software.

RS-232C Setup

i.e)

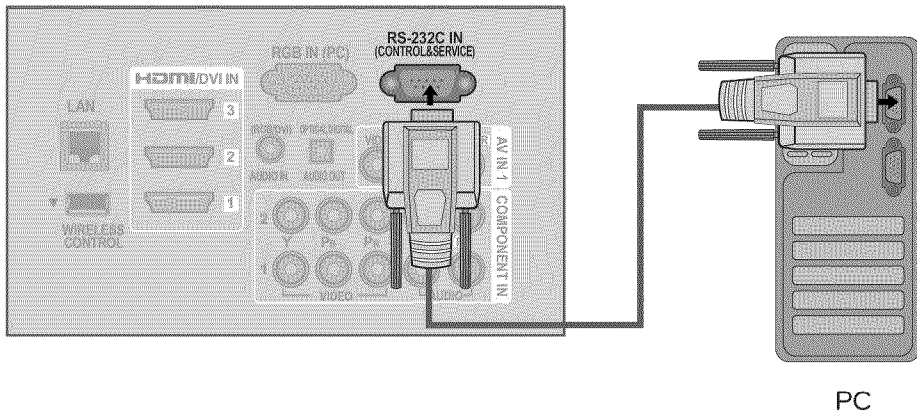

Type of Connector; D-Sub 9-Pin Male

Communication Parameters

No.	Pin Name
1	No connection
2	RXD (Receive data)
3	TXD (Transmit data)
4	DTR (DTE side ready)
5	GND
6	DSR (DCE side ready)
7	RTS (Ready to send)
8	CTS (Clear to send)
9	No Connection

- Baud rate : 9600 bps (UART)
- Data length : 8 bits
- Parity : None
- Stop bit : 1 bit
- Communication code : ASCII code
- Use a crossed (reverse) cable.

NOTE
 ▶ This product has command echo back in the RS-232C Command.

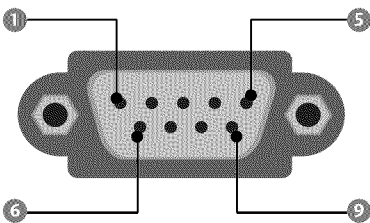

RS-232C Configurations

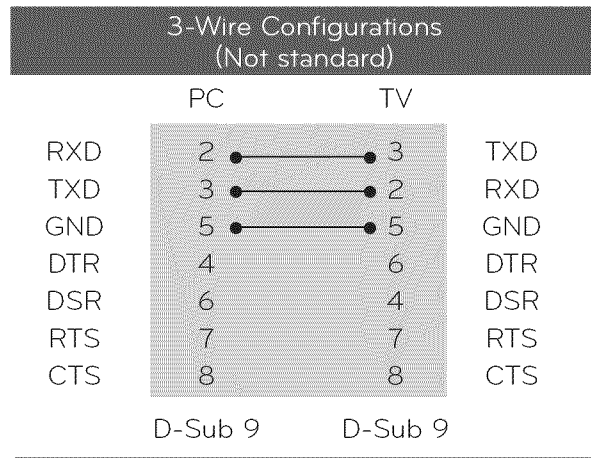
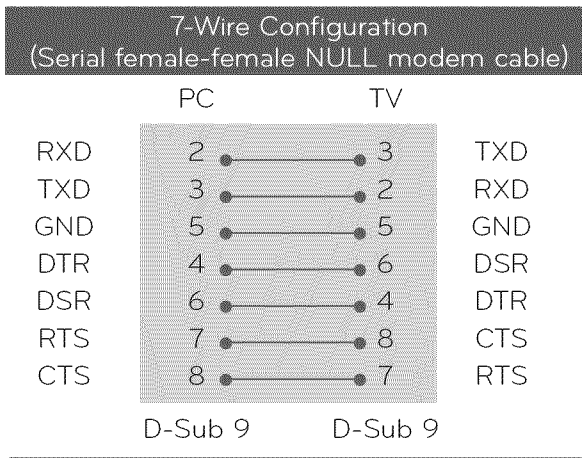

Set ID

Use this function to specify a TV ID number.
Refer to 'Real Data Mapping'.

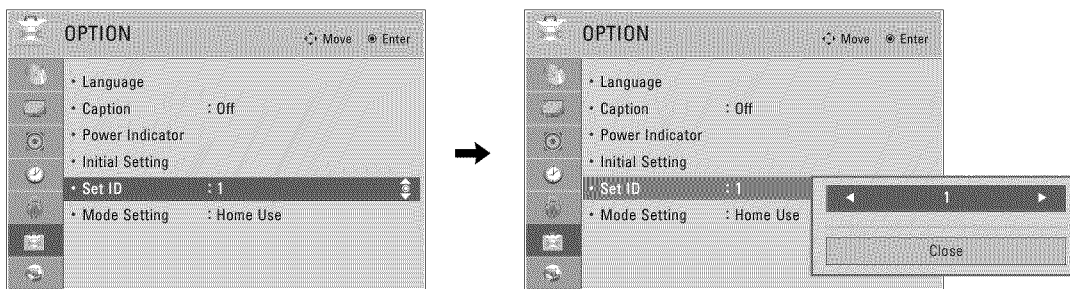

- 1 Select **OPTION**.
- 2 Select **Set ID**.
- 3 Choose the desired TV ID number.
The adjustment range of Set ID is 1~99.
- 4 Return to the previous menu.
- Return to TV viewing.

■ Real data mapping	
0	Step 0
⋮	
A	Step 10 (Set ID 10)
⋮	
F	Step 15 (Set ID 15)
10	Step 16 (Set ID 16)
⋮	
63	Step 99 (Set ID 99)
64	Step 100

APPENDIX

Command Reference List

	COMMAND1	COMMAND2	DATA (Hexadecimal)
01. Power	k	a	00 - 01
02. Input Select	x	b	▶ P185
03. Aspect Ratio	k	c	▶ P185
04. Screen Mute	k	d	00 - 01
05. Volume Mute	k	e	00 - 01
06. Volume Control	k	f	00 - 64
07. Contrast	k	g	00 - 64
08. Brightness	k	h	00 - 64
09. Color	k	i	00 - 64
10. Tint	k	j	00 - 64
11. Sharpness	k	k	00 - 64
12. OSD Select	k	l	00 - 01
13. Remote Control Lock Mode	k	m	00 - 01
14. Treble	k	r	00 - 64
15. Bass	k	s	00 - 64
16. Balance	k	t	00 - 64
17. Color Temperature	x	u	00 - 64
18. ISM Method	j	p	▶ P186
19. Energy Saving	j	q	▶ P186
20. Auto Configuration	j	u	▶ P186
22. Channel Add/Del	m	b	00 - 01
23. Key	m	c	▶ P187
24. Backlight	m	g	00 - 64

For LED LCD TV

For Plasma TV

	COMMAND1	COMMAND2	DATA00 (Hexadecimal)	DATA01 (Hexadecimal)		
21. Channel Tuning	m	a	physical program high	major program low		
			DATA02 (Hexadecimal)	DATA03 (Hexadecimal)	DATA04 (Hexadecimal)	DATA05 (Hexadecimal)
			major low	minor high	minor low	attribute

Transmission / Receiving Protocol

Transmission

[Command1][Command2][][Set ID][][Data][Cr]

[Command 1] : First command to control the set. (j, k, m or x)

[Command 2] : Second command to control the set.

[Set ID] : You can adjust the set ID to choose desired TV ID number in Setup menu. Adjustment range is 1-99. When selecting Set ID '0', every connected the TV is controlled. Set ID is indicated as decimal (1-99) on menu and as Hexa decimal (0x0 - 0x63) on transmission /receiving protocol.

[DATA] : To transmit the command data.

Transmit the 'FF' data to read status of command.

[Cr] : Carriage Return

ASCII code '0x0D'

[] : ASCII code 'space (0x20)'

* In this model, TV will not send the status during the standby mode.

OK Acknowledgement

[Command2][][Set ID][][OK][Data][x]

The TV transmits ACK (acknowledgement) based on this format when receiving normal data. At this time, if the data is data read mode, it indicates present status data. If the data is data write mode, it returns the data of the PC computer.

* In this model, TV will not send the status during the standby mode.

* Data Format

[Command 2] : Use as command.

[Set ID] : Use the small character, if set ID is 10, it will send the '0', 'a'.

[DATA] : Use the small character, if data is 0 x ab, it will send the 'a', 'b'.

[OK] : Use the large character.

Error Acknowledgement

[Command2][][Set ID][][NG][Data][x]

The TV transmits ACK (acknowledgement) based on this format when receiving abnormal data from non-viable functions or communication errors.

Data1: Illegal Code

Data2: Not supported function

Data3: Wait more time

* In this model, TV will not send the status during the standby mode.

* Data Format

[Command 2] : Use as command.

[Set ID] : Use the small character, if set ID is 10, it will send the '0', 'a'.

[DATA] : Use the small character, if data is 0 x ab, it will send the 'a', 'b'.

[NG] : Use the large character.

01. Power (Command: k a)

To control Power On/Off of the TV.

Transmission [k][a][][Set ID][][Data][Cr]

Data 00: Power Off Data 01: Power On

Acknowledgement [a][][Set ID][][OK/NG][Data][x]

* In a like manner, if other functions transmit 'FF' data based on this format, Acknowledgement data feedback presents status about each function.

* Note: In this model, TV will send the Acknowledge after power on processing completion.

There might be a time delay between command and acknowledge.

02. Input Select (Command: x b)

To select input source for TV.

Transmission [x][b][][Set ID][][Data][Cr]

Data 00: DTV (Antenna) Data 01: DTV (Cable)

Data 10: Analog (Antenna) Data 11: Analog (Cable)

Data 20: AV1 Data 21: AV 2

Data 40: Component1 Data 41: Component 2

Data 42: Component 3 Data 60: RGB-PC

Data 90: HDMI1 Data 91: HDMI2

Data 92: HDMI3 Data 93: HDMI4

Acknowledgement [b][][Set ID][][OK/NG][Data][x]

* Use the feature depending on your model.

03. Aspect Ratio (Command: k c)

To adjust the screen format.

Transmission [k][c][][Set ID][][Data][Cr]

Data 01: 4:3 Data 09: Just scan

Data 02: 16:9 Data 10: Cinema Zoom1

Data 04: Zoom :

Data 06: Set by program Data 1F: Cinema Zoom16

Acknowledgement [c][][Set ID][][OK/NG][Data][x]

04. Screen Mute (Command: k d)

To select screen mute on/off.

Transmission [k][d][][Set ID][][Data][Cr]

Data 00: Screen mute off (Picture on), Video-out Mute off

Data 01: Screen mute on (Picture off)

Data 10: Video-out Mute on

Acknowledgement [d][][Set ID][][OK/NG][Data][x]

* In case of Video-out Mute on only, TV will display On Screen Display (OSD). But, in case of screen mute on, TV will not display On Screen Display (OSD).

05. Volume Mute (Command: k e)

To control volume mute on/off.

You can also adjust mute using the MUTE button on remote control.

Transmission [k][e][][Set ID][][Data][Cr]

Data 00: Volume mute on (Volume off)

Data 01: Volume mute off (Volume on)

Acknowledgement [e][][Set ID][][OK/NG][Data][x]

06. Volume Control (Command: k f)

To adjust volume.

You can also adjust volume with the volume buttons on remote control.

Transmission [k][f][][Set ID][][Data][Cr]

Data Min: 00 - Max: 64 (*transmit by Hexadecimal code)

*Refer to 'Real data mapping'.

Acknowledgement [f][][Set ID][][OK/NG][Data][x]

07. Contrast (Command: k g)

To adjust screen contrast.

You can also adjust contrast in the PICTURE menu.

Transmission [k][g][][Set ID][][Data][Cr]

Data Min: 00 - Max: 64 (*transmit by Hexadecimal code)

*Refer to 'Real data mapping'.

Acknowledgement [g][][Set ID][][OK/NG][Data][x]

08. Brightness (Command: k h)

To adjust screen brightness.

You can also adjust brightness in the PICTURE menu.

Transmission [k][h][][Set ID][][Data][Cr]

Data Min: 00 - Max: 64 (*transmit by Hexadecimal code)

*Refer to 'Real data mapping'.

Acknowledgement [h][][Set ID][][OK/NG][Data][x]

09. Color (Command: k i)

To adjust screen color.

You can also adjust color in the PICTURE menu.

Transmission [k][i][][Set ID][][Data][Cr]

Data Min: 00 - Max: 64 (*transmit by Hexadecimal code)

*Refer to 'Real data mapping'.

Acknowledgement [i][][Set ID][][OK/NG][Data][x]

10. Tint (Command: k j)

To adjust screen tint.

You can also adjust tint in the PICTURE menu.

Transmission [k][j][][Set ID][][Data][Cr]

Data Red: 00 - Green: 64 (*transmit by Hexadecimal code)

*Refer to 'Real data mapping'.

Acknowledgement [j][][Set ID][][OK/NG][Data][x]

APPENDIX

11. Sharpness (Command: k k)

To adjust screen sharpness.

You can also adjust sharpness in the Picture menu.

Transmission [k][k][][Set ID][][Data][Cr]

Data Min: 00 - Max: 64 (*transmit by Hexadecimal code)

*Refer to 'Real data mapping'.

Acknowledgement [k][][Set ID][][OK/NG][Data][x]

12. OSD Select (Command: k l)

To select OSD (On Screen Display) on/off.

Transmission [k][l][][Set ID][][Data][Cr]

Data 00: OSD off Data 01: OSD on

Acknowledgement [l][][Set ID][][OK/NG][Data][x]

13. Remote Control Lock Mode (Command: k m)

To lock the remote control and the front panel controls on the set.

Transmission [k][m][][Set ID][][Data][Cr]

Data 00: Lock off Data 01: Lock on

Acknowledgement [m][][Set ID][][OK/NG][Data][x]

If you're not using the remote control and front panel controls on the TV, use this mode. When main power is on/off, remote control lock is released.

If Key Lock is on in the standby mode, TV will not turn on by POWER button of remote control and on the TV.

14. Treble (Command: k r)

To adjust treble.

You can also adjust treble in the Audio menu.

Transmission [k][r][][Set ID][][Data][Cr]

Data Min: 00 - Max: 64 (*transmit by Hexadecimal code)

*Refer to 'Real data mapping'.

Acknowledgement [r][][Set ID][][OK/NG][Data][x]

15. Bass (Command: k s)

To adjust bass.

You can also adjust bass in the Audio menu.

Transmission [k][s][][Set ID][][Data][Cr]

Data Min: 00 - Max: 64 (*transmit by Hexadecimal code)

*Refer to 'Real data mapping'.

Acknowledgement [s][][Set ID][][OK/NG][Data][x]

16. Balance (Command: k t)

To adjust balance.

You can also adjust balance in the Audio menu.

Transmission [k][t][][Set ID][][Data][Cr]

Data Min: 00 - Max: 64 (*transmit by Hexadecimal code)

*Refer to 'Real data mapping'.

Acknowledgement [t][][Set ID][][OK/NG][Data][x]

17. Color Temperature (Command: x u)

To adjust color temperature.

You can also adjust color temperature in the Picture menu.

Transmission [x][u][][Set ID][][Data][Cr]

Data Warm: 00 - Cool: 64 (*transmit by Hexadecimal code)

*Refer to 'Real data mapping'.

Acknowledgement [u][][Set ID][][OK/NG][Data][x]

18. ISM Method (Command: j p) (For Plasma TV)

To avoid having a fixed image remain on screen.

Transmission [j][p][][Set ID][][Data][Cr]

Data 02: Orbiter 04: White Wash

Data 08: Normal 20: Color Wash

Acknowledgement [p][][Set ID][][OK/NG][Data][x]

19. Energy Saving (Command: j q)

To control the energy saving function.

Transmission [j][q][][Set ID][][Data][Cr]

Data 00: Off Data 01: Minimum

Data 02: Medium Data 03: Maximum

Data 04: Auto/Intelligent Sensor (depending on model)

Data 05: Screen off

Acknowledgement [q][][Set ID][][OK/NG][Data][x]

20. Auto Configuration (Command: j u)

To adjust picture position and minimize image shaking automatically. Auto configuration only works in RGB-PC mode.

Transmission [j][u][][Set ID][][Data][Cr]

Data 01: To set

Acknowledgement [u][][Set ID][][OK/NG][Data][x]

21. Channel Tuning (Command: m a)

To tune channel to following physical/major/minor number.

Transmission [m][a][][Set ID][][Data00][][Data01]

[][Data02][][Data03][][Data04][][Data05][Cr]

Digital channels have a Physical, Major, and Minor channel number. The Physical number is the actual digital channel number, the Major is the number that the channel should be mapped to, and the Minor is the sub-channel. Since the ATSC tuner automatically maps the channel to the Major number, the Physical number is not required when sending a command.

Data 00: Physical Channel Number

NTSC air: 02 - 45, NTSC cable: 01, 0E - 7D

ATSC air: 01 - 45, ATSC cable: 01 - 87

Data 01 & 02: Major Channel Number

Data 01: High byte Data 02: Low byte

Two bytes are available for the Major and Minor, normally only the second byte is used.

Data 03 & 04: Minor Channel Number

Not needed for NTSC.

Data5:	7 Main/Sub Picture	6 Two/One Part Channel	5 Using Physical Channel	4 Reserved	3	2	1	0	Step
	0 Main	0 Two	0 Use	x	0	0	0	0	NTSC Air
	1 Sub	1 One	1 No Use	x	0	0	0	1	NTSC Cable
				x	0	0	1	0	ATSC Air
				x	0	0	1	1	ATSC Cable_std
				x	0	1	0	0	ATSC Cable_hrc
				x	0	1	0	1	ATSC Cable_irc
				x	0	1	1	0	ATSC cable_auto
				x	0	1	1	1	Reserved
				x	x	x	x	x	...
				x	1	1	1	1	Reserved

The table above lists the binary code which must be converted to Hexadecimal before sending. For example: The binary code to tune the sub source to an NTSC cable channel is "1000 0001", which translates to "81" in Hex.

- * 7th bit : For which source do you want to change the channel.
- * 6th bit: Use a two part or one part channel. Most cases just use 0 since it's ignored when using NTSC.
- * 5th bit: Use 0 with NTSC since it can only use the physical channel number. Normally use 1 for ATSC since most times it doesn't matter what the physical number is.
- * 4th bit: Set to 0.
- * 3-0 bits: Choose signal type.

*Tune Command Examples:

1. Tune to the analog (NTSC) cable channel 35.

Data 00 = Physical of 35 = 23
 Data 01 & 02 = No Major = 00 00
 Data 03 & 04 = No Minor = 00 00
 Data 05 = 0000 0001 in binary = 01
 Total = ma 00 23 00 00 00 00 01

2. Tune to the digital local channel 30-3.

Data 00 = Don't know Physical = 00
 Data 01 & 02 = Major is 30 = 00 1E
 Data 03 & 04 = Minor is 3 = 00 03
 Data 05 = 0010 0010 in binary = 22
 Total = ma 00 00 00 1E 00 03 22

Acknowledgement[a][][Set ID][][OK][Data00]
 [Data01] [Data02][Data03][Data04][x][a][][Set ID][
 [NG][Data00][x]

22. Channel Add/Del (Command: m b)

To add and delete the channels.

Transmission [m][b][][Set ID][][Data][Cr]

Data 00: Channel Delete Data 01: Channel Add

Acknowledgement [b][][Set ID][][OK/NG][Data][x]

23. Key (Command: m c)

To send IR remote control code.

Transmission [m][c][][Set ID][][Data][Cr]

See page 181.

Acknowledgement [c][][Set ID][][OK/NG][Data][x]

24. Backlight (Command: m g) (For LED LCD TV)

To adjust screen backlight.

Transmission [m][g][][Set ID][][Data][Cr]

Data Min:00 ~ Max:64 (*transmit by Hexadecimal code)

*Refer to 'Real data mapping'.

Acknowledgement [g][][Set ID][][OK/NG][Data][x]

APPENDIX

OPEN SOURCE LICENSE

GNU GENERAL PUBLIC LICENSE

Version 2, June 1991

Copyright (C) 1989, 1991 Free Software Foundation, Inc., 51 Franklin Street, Fifth Floor, Boston, MA 02110-1301 USA

Everyone is permitted to copy and distribute verbatim copies of this license document, but changing it is not allowed.

Preamble

The licenses for most software are designed to take away your freedom to share and change it. By contrast, the GNU General Public License is intended to guarantee your freedom to share and change free software - to make sure the software is free for all its users. This General Public License applies to most of the Free Software Foundation's software and to any other program whose authors commit to using it. (Some other free software foundation software is covered by the GNU Lesser General Public License instead.) You can apply it to your programs, too.

When we speak of free software, we are referring to freedom, not price. Our General Public Licenses are designed to make sure that you have the freedom to distribute copies of free software (and charge for this service if you wish), that you receive source code or can get it if you want it, that you can change the software or use pieces of it in new free programs; and that you know you can do these things.

To protect your rights, we need to make restrictions that forbid anyone to deny you these rights or to ask you to surrender the rights. These restrictions translate to certain responsibilities for you if you distribute copies of the software, or if you modify it.

For example, if you distribute copies of such a program, whether gratis or for a fee, you must give the recipients all the rights that you have. You must make sure that they, too, receive or can get the source code. And you must show them these terms so they know their rights.

We protect your rights with two steps: (1) copyright the software, and (2) offer you this license which gives you legal permission to copy, distribute and/or modify the software.

Also, for each author's protection and ours, we want to make certain that everyone understands that there is no warranty for this free software. If the software is modified by someone else and passed on, we want its recipients to know that what they have is not the original, so that any problems introduced by others will not reflect on the original authors' reputations.

Finally, any free program is threatened constantly by software patents. We wish to avoid the danger that redistributors of a free program will individually obtain patent licenses, in effect making the program proprietary. To prevent this, we have made it clear that any patent must be

licensed for everyone's free use or not licensed at all.

The precise terms and conditions for copying, distribution and modification follow.

GNU GENERAL PUBLIC LICENSE TERMS AND CONDITIONS FOR COPYING, DISTRIBUTION AND MODIFICATION

0. This license applies to any program or other work which contains a notice placed by the copyright holder saying it may be distributed under the terms of this General Public License. The "Program", below, refers to any such program or work, and a "work based on the Program" means either the Program or any derivative work under copyright law: that is to say, a work containing the Program or a portion of it, either verbatim or with modifications and/or translated into another language. (Hereinafter, translation is included without limitation in the term "modification".) Each licensee is addressed as "you".

Activities other than copying, distribution and modification are not covered by this license; they are outside its scope. The act of running the Program is not restricted, and the output from the program is covered only if its contents constitute a work based on the program (independent of having been made by running the program). Whether that is true depends on what the program does.

1. You may copy and distribute verbatim copies of the program's source code as you receive it, in any medium, provided that you conspicuously and appropriately publish on each copy an appropriate copyright notice and disclaimer of warranty; keep intact all the notices that refer to this license and to the absence of any warranty; and give any other recipients of the program a copy of this license along with the Program.

You may charge a fee for the physical act of transferring a copy, and you may at your option offer warranty protection in exchange for a fee.

2. You may modify your copy or copies of the program or any portion of it, thus forming a work based on the Program, and copy and distribute such modifications or work under the terms of section 1 above, provided that you also meet all of these conditions:

a) You must cause the modified files to carry prominent notices stating that you changed the files and the date of any change.

- b) You must cause any work that you distribute or publish, that in whole or in part contains or is derived from the Program or any part thereof, to be licensed as a whole at no charge to all third parties under the terms of this license.
- c) If the modified program normally reads commands interactively when run, you must cause it, when started running for such interactive use in the most ordinary way, to print or display an announcement including an appropriate copyright notice and a notice that there is no warranty (or else, saying that you provide a warranty) and that users may redistribute the program under these conditions, and telling the user how to view a copy of this license. (Exception: if the Program itself is interactive but does not normally print such an announcement, your work based on the Program is not required to print an announcement.)

These requirements apply to the modified work as a whole. If identifiable sections of that work are not derived from the Program, and can be reasonably considered independent and separate works in themselves, then this license, and its terms, do not apply to those sections when you distribute them as separate works. But when you distribute the same sections as part of a whole which is a work based on the Program, the distribution of the whole must be on the terms of this license, whose permissions for other licensees extend to the entire whole, and thus to each and every part regardless of who wrote it.

Thus, it is not the intent of this section to claim rights or contest your rights to work written entirely by you; rather, the intent is to exercise the right to control the distribution of derivative or collective works based on the program.

In addition, mere aggregation of another work not based on the program with the Program (or with a work based on the program) on a volume of a storage or distribution medium does not bring the other work under the scope of this license.

- 3. You may copy and distribute the program (or a work based on it, under section 2) in object code or executable form under the terms of sections 1 and 2 above provided that you also do one of the following:
 - a) Accompany it with the complete corresponding machine-readable source code, which must be distributed under the terms of sections 1 and 2 above on a medium customarily used for software interchange; or,
 - b) Accompany it with a written offer, valid for at least three years, to give any third party, for a charge no more than your cost of physically performing source distribution, a complete machine-readable copy of the corresponding source code, to be distributed under the terms of sections 1 and 2 above on a medium customarily used for software interchange; or,

- c) Accompany it with the information you received as to the offer to distribute corresponding source code. (This alternative is allowed only for noncommercial distribution and only if you received the program in object code or executable form with such an offer, in accord with Subsection b above.)

The source code for a work means the preferred form of the work for making modifications to it. For an executable work, complete source code means all the source code for all modules it contains, plus any associated interface definition files, plus the scripts used to control compilation and installation of the executable. However, as a special exception, the source code distributed need not include anything that is normally distributed (in either source or binary form) with the major components (compiler, kernel, and so on) of the operating system on which the executable runs, unless that component itself accompanies the executable.

If distribution of executable or object code is made by offering access to copy from a designated place, then offering equivalent access to copy the source code from the same place counts as distribution of the source code, even though third parties are not compelled to copy the source along with the object code.

- 4. You may not copy, modify, sublicense, or distribute the Program except as expressly provided under this license. Any attempt otherwise to copy, modify, sublicense or distribute the Program is void, and will automatically terminate your rights under this license. However, parties who have received copies, or rights, from you under this license will not have their licenses terminated so long as such parties remain in full compliance.
- 5. You are not required to accept this license, since you have not signed it. However, nothing else grants you permission to modify or distribute the Program or its derivative works. These actions are prohibited by law if you do not accept this license. Therefore, by modifying or distributing the program (or any work based on the program), you indicate your acceptance of this license to do so, and all its terms and conditions for copying, distributing or modifying the program or works based on it.
- 6. Each time you redistribute the program (or any work based on the Program), the recipient automatically receives a license from the original licensor to copy, distribute or modify the Program subject to these terms and conditions. You may not impose any further restrictions on the recipients' exercise of the rights granted herein. You are not responsible for enforcing compliance by third parties to this license.

APPENDIX

7. If, as a consequence of a court judgment or allegation of patent infringement or for any other reason (not limited to patent issues), conditions are imposed on you (whether by court order, agreement or otherwise) that contradict the conditions of this license, they do not excuse you from the conditions of this license. If you cannot distribute so as to satisfy simultaneously your obligations under this license and any other pertinent obligations, then as a consequence you may not distribute the program at all. For example, if a patent license would not permit royalty-free redistribution of the program by all those who receive copies directly or indirectly through you, then the only way you could satisfy both it and this license would be to refrain entirely from distribution of the program.

If any portion of this section is held invalid or unenforceable under any particular circumstance, the balance of the section is intended to apply and the section as a whole is intended to apply in other circumstances.

It is not the purpose of this section to induce you to infringe any patents or other property right claims or to contest validity of any such claims; this section has the sole purpose of protecting the integrity of the free software distribution system, which is implemented by public license practices. Many people have made generous contributions to the wide range of software distributed through that system in reliance on consistent application of that system; it is up to the author/donor to decide if he or she is willing to distribute software through any other system and a licensee cannot impose that choice.

This section is intended to make thoroughly clear what is believed to be a consequence of the rest of this license.

8. If the distribution and/or use of the program is restricted in certain countries either by patents or by copyrighted interfaces, the original copyright holder who places the program under this license may add an explicit geographical distribution limitation excluding those countries, so that distribution is permitted only in or among countries not thus excluded. In such case, this license incorporates the limitation as if written in the body of this license.
9. The Free Software Foundation may publish revised and/or new versions of the General Public License from time to time. Such new versions will be similar in spirit to the present version, but may differ in detail to address new problems or concerns.

Each version is given a distinguishing version number. If

the program specifies a version number of this license which applies to it and "any later version", you have the option of following the terms and conditions either of that version or of any later version published by the Free Software Foundation. If the program does not specify a version number of this license, you may choose any version ever published by the Free Software Foundation.

10. If you wish to incorporate parts of the program into other free programs whose distribution conditions are different, write to the author to ask for permission. For software which is copyrighted by the Free Software Foundation, write to the Free Software Foundation; we sometimes make exceptions for this. Our decision will be guided by the two goals of preserving the free status of all derivatives of our free software and of promoting the sharing and reuse of software generally.

NO WARRANTY

11. BECAUSE THE PROGRAM IS LICENSED FREE OF CHARGE, THERE IS NO WARRANTY FOR THE PROGRAM, TO THE EXTENT PERMITTED BY APPLICABLE LAW. EXCEPT WHEN OTHERWISE STATED IN WRITING THE COPYRIGHT HOLDERS AND/OR OTHER PARTIES PROVIDE THE PROGRAM "AS IS" WITHOUT WARRANTY OF ANY KIND, EITHER EXPRESSED OR IMPLIED, INCLUDING, BUT NOT LIMITED TO, THE IMPLIED WARRANTIES OF MERCHANTABILITY AND FITNESS FOR A PARTICULAR PURPOSE. THE ENTIRE RISK AS TO THE QUALITY AND PERFORMANCE OF THE PROGRAM IS WITH YOU. SHOULD THE PROGRAM PROVE DEFECTIVE, YOU ASSUME THE COST OF ALL NECESSARY SERVICING, REPAIR OR CORRECTION.

12. IN NO EVENT UNLESS REQUIRED BY APPLICABLE LAW OR AGREED TO IN WRITING WILL ANY COPYRIGHT HOLDER, OR ANY OTHER PARTY WHO MAY MODIFY AND/OR REDISTRIBUTE THE PROGRAM AS PERMITTED ABOVE, BE LIABLE TO YOU FOR DAMAGES, INCLUDING ANY GENERAL, SPECIAL, INCIDENTAL OR CONSEQUENTIAL DAMAGES ARISING OUT OF THE USE OR INABILITY TO USE THE PROGRAM (INCLUDING BUT NOT LIMITED TO LOSS OF DATA OR DATA BEING RENDERED INACCURATE OR LOSSES SUSTAINED BY YOU OR THIRD PARTIES OR A FAILURE OF THE PROGRAM TO OPERATE WITH ANY OTHER PROGRAMS), EVEN IF SUCH HOLDER OR OTHER PARTY HAS BEEN ADVISED OF THE POSSIBILITY OF SUCH DAMAGES.

END OF TERMS AND CONDITIONS

How to apply these terms to your new programs

If you develop a new program, and you want it to be of the greatest possible use to the public, the best way to achieve this is to make it free software which everyone can redistribute and change under these terms.

To do so, attach the following notices to the program. It is safest to attach them to the start of each source file to most effectively convey the exclusion of warranty; and each file should have at least the "copyright" line and a pointer to where the full notice is found.

one line to give the program's name and a brief idea of what it does.

Copyright (C) <year> <name of author>

This program is free software; you can redistribute it and/or modify it under the terms of the GNU General Public License as published by the Free Software Foundation; either version 2 of the license, or (at your option) any later version.

This program is distributed in the hope that it will be useful, but WITHOUT ANY WARRANTY; without even the implied warranty of MERCHANTABILITY or FITNESS FOR A PARTICULAR PURPOSE. See the GNU General Public License for more details.

You should have received a copy of the GNU General Public License along with this program; if not, write to the Free Software Foundation, Inc., 51 Franklin Street, Fifth Floor, Boston, MA 02110-1301 USA.

Also add information on how to contact you by electronic and paper mail.

If the program is interactive, make it output a short notice like this when it starts in an interactive mode:

Gnomovision version 69, Copyright (C) year name of author
Gnomovision comes with ABSOLUTELY NO WARRANTY;
for details type 'show w'. This is free software, and you are
welcome to redistribute it under certain conditions; type
'show c' for details.

The hypothetical commands 'show w' and 'show c' should show the appropriate parts of the General Public License. Of course, the commands you use may be called something other than 'show w' and 'show c'; they could even be mouse-clicks or menu items-whatever suits your program.

You should also get your employer (if you work as a programmer) or your school, if any, to sign a "copyright disclaimer" for the program, if necessary. Here is a sample; alter the names:

Yoyodyne, Inc., hereby disclaims all copyright interest in the program 'Gnomovision' (which makes passes at compilers) written by James Hacker.

signature of Ty Coon, 1 April 1989
Ty Coon, President of Vice

This General Public License does not permit incorporating your program into proprietary programs. If your program is a subroutine library, you may consider it more useful to permit linking proprietary applications with the library. If this is what you want to do, use the GNU Lesser General Public License instead of this license.

GNU LESSER GENERAL PUBLIC LICENSE

Version 2.1, February 1999

Copyright (C) 1991, 1999 Free Software Foundation, Inc. 51 Franklin Street, Fifth Floor, Boston, MA 02110-1301 USA
Everyone is permitted to copy and distribute verbatim copies of this license document, but changing it is not allowed.

[This is the first released version of the Lesser GPL. It also counts as the successor of the GNU Library Public License, version 2, hence the version number 2.1.]

Preamble

The licenses for most software are designed to take away your freedom to share and change it. By contrast, the GNU General Public Licenses are intended to guarantee your freedom to share and change free software - to make sure the software is free for all its users.

This license, the Lesser General Public License, applies to some specially designated software packages - typically libraries - of the Free Software Foundation and other authors who decide to use it. You can use it too, but we suggest you first think carefully about whether this license or the ordinary General Public License is the better strategy to use in any particular case, based on the explanations below.

When we speak of free software, we are referring to freedom of use, not price. Our General Public Licenses are designed to make sure that you have the freedom to distribute copies of free software (and charge for this service if you wish); that you receive source code or can get it if you want it; that you can change the software and use pieces of it in new free programs; and that you are informed that you can do these things.

To protect your rights, we need to make restrictions that forbid distributors to deny you these rights or to ask you to surrender these rights. These restrictions translate to certain responsibilities for you if you distribute copies of the library or if you modify it.

For example, if you distribute copies of the library, whether gratis or for a fee, you must give the recipients all the rights that we gave you. You must make sure that they, too, receive or can get the source code. If you link other code with the library, you must provide complete object files to the recipients, so that they can relink them with the library after making changes to the library and recompiling it. And you must show them these terms so they know their rights.

We protect your rights with a two-step method: (1) we copyright the library, and (2) we offer you this license, which gives you legal permission to copy, distribute and/or modify the library.

To protect each distributor, we want to make it very clear

that there is no warranty for the free library. Also, if the library is modified by someone else and passed on, the recipients should know that what they have is not the original version, so that the original author's reputation will not be affected by problems that might be introduced by others.

Finally, software patents pose a constant threat to the existence of any free program. We wish to make sure that a company cannot effectively restrict the users of a free program by obtaining a restrictive license from a patent holder. Therefore, we insist that any patent license obtained for a version of the library must be consistent with the full freedom of use specified in this license.

Most GNU software, including some libraries, is covered by the ordinary GNU General Public License. This license, the GNU Lesser General Public License, applies to certain designated libraries, and is quite different from the ordinary General Public License. We use this license for certain libraries in order to permit linking those libraries into non-free programs.

When a program is linked with a library, whether statically or using a shared library, the combination of the two is legally speaking a combined work, a derivative of the original library. The ordinary General Public License therefore permits such linking only if the entire combination fits its criteria of freedom. The Lesser General Public License permits more lax criteria for linking other code with the library.

We call this license the "Lesser" General Public License because it does Less to protect the user's freedom than the ordinary General Public License. It also provides other free software developers Less of an advantage over competing non-free programs. These disadvantages are the reason we use the ordinary General Public License for many libraries. However, the Lesser license provides advantages in certain special circumstances.

For example, on rare occasions, there may be a special need to encourage the widest possible use of a certain library, so that it becomes a de-facto standard. To achieve this, non-free programs must be allowed to use the library. A more frequent case is that a free library does the same job as widely used non-free libraries. In this case, there is little to gain by limiting the free library to free software only, so we use the Lesser General Public License.

In other cases, permission to use a particular library in non-free programs enables a greater number of people to use a large body of free software. For example, permission to use the GNU C Library in non-free programs enables many more people to use the whole GNU operating system, as well as its variant, the GNU/Linux operating system.

Although the Lesser General Public License is less protective of the users' freedom, it does ensure that the user of a program that is linked with the Library has the freedom and the wherewithal to run that program using a modified version of the Library.

The precise terms and conditions for copying, distribution and modification follow. Pay close attention to the difference between a "work based on the library" and a "work that uses the library". The former contains code derived from the library, whereas the latter must be combined with the library in order to run.

GNU LESSER GENERAL PUBLIC LICENSE TERMS AND CONDITIONS FOR COPYING, DISTRIBUTION AND MODIFICATION

0. This license agreement applies to any software library or other program which contains a notice placed by the copyright holder or other authorized party saying it may be distributed under the terms of this Lesser General Public License (also called "this license"). Each license is addressed as "you".

A "library" means a collection of software functions and/or data prepared so as to be conveniently linked with application programs (which use some of those functions and data) to form executables.

The "Library", below, refers to any such software library or work which has been distributed under these terms. A "work based on the Library" means either the Library or any derivative work under copyright law: that is to say, a work containing the library or a portion of it, either verbatim or with modifications and/or translated straightforwardly into another language. (Hereinafter, translation is included without limitation in the term "modification".)

"Source code" for a work means the preferred form of the work for making modifications to it. For a library, complete source code means all the source code for all modules it contains, plus any associated interface definition files, plus the scripts used to control compilation and installation of the library.

Activities other than copying, distribution and modification are not covered by this license; they are outside its scope. The act of running a program using the Library is not restricted, and output from such a program is covered only if its contents constitute a work based on the library (independent of the use of the Library in a tool for writing it). Whether that is true depends on what the library does and what the program that uses the library does.

1. You may copy and distribute verbatim copies of the library's complete source code as you receive it, in any medium, provided that you conspicuously and appropriately publish on each copy an appropriate copyright notice and disclaimer of warranty; keep intact all the

notices that refer to this license and to the absence of any warranty; and distribute a copy of this license along with the Library.

You may charge a fee for the physical act of transferring a copy, and you may at your option offer warranty protection in exchange for a fee.

2. You may modify your copy or copies of the Library or any portion of it, thus forming a work based on the Library, and copy and distribute such modifications or work under the terms of section 1 above, provided that you also meet all of these conditions:
- The modified work must itself be a software library.
 - You must cause the files modified to carry prominent notices stating that you changed the files and the date of any change.
 - You must cause the whole of the work to be licensed at no charge to all third parties under the terms of this license.
 - If a facility in the modified Library refers to a function or a table of data to be supplied by an application program that uses the facility, other than as an argument passed when the facility is invoked, then you must make a good faith effort to ensure that, in the event an application does not supply such function or table, the facility still operates, and performs whatever part of its purpose remains meaningful.

(For example, a function in a library to compute square roots has a purpose that is entirely well-defined independent of the application. Therefore, Subsection 2d requires that any application-supplied function or table used by this function must be optional: if the application does not supply it, the square root function must still compute square roots.)

These requirements apply to the modified work as a whole. If identifiable sections of that work are not derived from the library, and can be reasonably considered independent and separate works in themselves, then this license, and its terms, do not apply to those sections when you distribute them as separate works. But when you distribute the same sections as part of a whole which is a work based on the library, the distribution of the whole must be on the terms of this license, whose permissions for other licenses extend to the entire whole, and thus to each and every part regardless of who wrote it.

Thus, it is not the intent of this section to claim rights or contest your rights to work written entirely by you; rather, the intent is to exercise the right to control the distribution of derivative or collective works based on the library.

In addition, mere aggregation of another work not based on the library with the library (or with a work based on the library) on a volume of a storage or distribution medium does not bring the other work under the scope of this license.

APPENDIX

3. You may opt to apply the terms of the ordinary GNU General Public License instead of this License to a given copy of the Library. To do this, you must alter all the notices that refer to this License, so that they refer to the ordinary GNU General Public License, version 2, instead of to this License. (If a newer version than version 2 of the ordinary GNU General Public License has appeared, then you can specify that version instead if you wish.) Do not make any other change in these notices.

Once this change is made in a given copy, it is irreversible for that copy, so the ordinary GNU General Public License applies to all subsequent copies and derivative works made from that copy.

This option is useful when you wish to copy part of the code of the library into a program that is not a library.

4. You may copy and distribute the library (or a portion or derivative of it, under Section 2) in object code or executable form under the terms of Sections 1 and 2 above provided that you accompany it with the complete corresponding machine-readable source code, which must be distributed under the terms of sections 1 and 2 above on a medium customarily used for software interchange.

If distribution of object code is made by offering access to copy from a designated place, then offering equivalent access to copy the source code from the same place satisfies the requirement to distribute the source code, even though third parties are not compelled to copy the source along with the object code.

5. A program that contains no derivative of any portion of the Library, but is designed to work with the Library by being compiled or linked with it, is called a "work that uses the Library". Such a work, in isolation, is not a derivative work of the Library, and therefore falls outside the scope of this license.

However, linking a "work that uses the library" with the Library creates an executable that is a derivative of the Library (because it contains portions of the library), rather than a "work that uses the library". The executable is therefore covered by this license. Section 6 states terms for distribution of such executable.

When a "work that uses the library" uses material from a header file that is part of the library, the object code for the work may be a derivative work of the library even though the source code is not.

Whether this is true is especially significant if the work can be linked without the library, or if the work is itself a library. The threshold for this to be true is not precisely defined by law.

If such an object file uses only numerical parameters, data structure layouts and accessories, and small macros and small inline functions (ten lines or less in length), then the use of the object file is unrestricted, regardless of whether it is legally a derivative work. (Executable containing this object code plus portions of

the library will still fall under Section 6.)

Otherwise, if the work is a derivative of the library, you may distribute the object code for the work under the terms of Section 6. Any executable containing that work also fall under Section 6, whether or not they are linked directly with the library itself.

6. As an exception to the sections above, you may also combine or link a "work that uses the library" with the library to produce a work containing portions of the library, and distribute that work under terms of your choice, provided that the terms permit modification of the work for the customer's own use and reverse engineering for debugging such modifications.

You must give prominent notice with each copy of the work that the library is used in it and that the Library and its use are covered by this license. You must supply a copy of this license. If the work during execution displays copyright notices, you must include the copyright notice for the library among them, as well as a reference directing the user to the copy of this license. Also, you must do one of these things:

- a) Accompany the work with the complete corresponding machine-readable source code for the library including whatever changes were used in the work (which must be distributed under Sections 1 and 2 above); and, if the work is an executable linked with the Library, with the complete machine-readable "work that uses the Library", as object code and/or source code, so that the user can modify the library and then relink to produce a modified executable containing the modified library. (It is understood that the user who changes the contents of definitions files in the library will not necessarily be able to recompile the application to use the modified definitions.)
- b) Use a suitable shared library mechanism for linking with the library. A suitable mechanism is one that (1) uses at run time a copy of the library already present on the user's computer system, rather than copying library functions into the executable, and (2) will operate properly with a modified version of the library, if the user installs one, as long as the modified version is interface-compatible with the version that the work was made with.
- c) Accompany the work with a written offer, valid for at least three years, to give the same user the materials specified in Subsection 6, above, for a charge no more than the cost of performing this distribution.
- d) If distribution of the work is made by offering access to copy from a designated place, offer equivalent access to copy the above specified materials from the same place.
- e) Verify that the user has already received a copy of these materials or that you have already sent this user a copy.

For an executable, the required form of the "work that uses the library" must include any data and utility programs needed for reproducing the executable from it. However, as a special exception, the materials to be distributed need not include anything that is normally distributed (in either source or binary form) with the major components (compiler, kernel, and so on) of the operating system on which the executable runs, unless that component itself accompanies the executable.

It may happen that this requirement contradicts the license restrictions of other proprietary libraries that do not normally accompany the operating system. Such a contradiction means you cannot use both them and the library together in an executable that you distribute.

7. You may place library facilities that are a work based on the library side-by-side in a single library together with other library facilities not covered by this license, and distribute such a combined library, provided that the separate distribution of the work based on the Library and of the other library facilities is otherwise permitted, and provided that you do these two things:
 - a) Accompany the combined library with a copy of the same work based on the Library, uncombined with any other library facilities. This must be distributed under the terms of the sections above.
 - b) Give prominent notice with the combined library of the fact that part of it is a work based on the library, and explaining where to find the accompanying uncombined form of the same work.
 8. You may not copy, modify, sublicense, link with, or distribute the library except as expressly provided under this license. Any attempt otherwise to copy, modify, sublicense, link with, or distribute the library is void, and will automatically terminate your rights under this license. However, parties who have received copies, or rights, from you under this license will not have their licenses terminated so long as such parties remain in full compliance.
 9. You are not required to accept this license, since you have not signed it. However, nothing else grants you permission to modify or distribute the library or its derivative works. These actions are prohibited by law if you do not accept this license. Therefore, by modifying or distributing the library (or any work based on the library), you indicate your acceptance of this license to do so, and all its terms and conditions for copying, distributing or modifying the library or works based on it.
 10. Each time you redistribute the library (or any work based on the Library), the recipient automatically receives a license from the original licensor to copy, distribute, link with or modify the library subject to these terms and conditions. You may not impose any further restrictions on the recipients' exercise of the rights granted herein.
- You are not responsible for enforcing compliance by third parties with this license.
11. If, as a consequence of a court judgment or allegation of patent infringement or for any other reason (not limited to patent issues), conditions are imposed on you (whether by court order, agreement or otherwise) that contradict the conditions of this license, they do not excuse you from the conditions of this license. If you cannot distribute so as to satisfy simultaneously your obligations under this license and any other pertinent obligations, then as a consequence you may not distribute the library at all. For example, if a patent license would not permit royalty-free redistribution of the library by all those who receive copies directly or indirectly through you, then the only way you could satisfy both it and this license would be to refrain entirely from distribution of the library.

If any portion of this section is held invalid or unenforceable under any particular circumstance, the balance of the section is intended to apply, and the section as a whole is intended to apply in other circumstances.

It is not the purpose of this section to induce you to infringe any patents or other property right claims or to contest validity of any such claims; this section has the sole purpose of protecting the integrity of the free software distribution system which is implemented by public license practices. Many people have made generous contributions to the wide range of software distributed through that system in reliance on consistent application of that system; it is up to the author/donor to decide if he or she is willing to distribute software through any other system and a license cannot impose that choice.

This section is intended to make thoroughly clear what is believed to be a consequence of the rest of this license.
 12. If the distribution and/or use of the library is restricted in certain countries either by patents or by copyrighted interfaces, the original copyright holder who places the library under this license may add an explicit geographical distribution limitation excluding those countries, so that distribution is permitted only in or among countries not thus excluded. In such case, this license incorporates the limitation as if written in the body of this license.
 13. The Free Software Foundation may publish revised and/or new versions of the Lesser General Public License from time to time. Such new versions will be similar in spirit to the present version, but may differ in detail to address new problems or concerns.

Each version is given a distinguishing version number. If the library specifies a version number of this license which applies to it and "any later version", you have the option of following the terms and conditions either of that version or of any later version published by the Free Software Foundation.

APPENDIX

If the library does not specify a license version number, you may choose any version ever published by the Free Software Foundation.

14. If you wish to incorporate parts of the library into other free programs whose distribution conditions are incompatible with these, write to the author to ask for permission. For software which is copyrighted by the Free Software Foundation, write to the Free Software Foundation; we sometimes make exceptions for this. Our decision will be guided by the two goals of preserving the free status of all derivatives of our free software and of promoting the sharing and reuse of software generally.

NO WARRANTY

15. BECAUSE THE LIBRARY IS LICENSED FREE OF CHARGE, THERE IS NO WARRANTY FOR THE LIBRARY, TO THE EXTENT PERMITTED BY APPLICABLE LAW. EXCEPT WHEN OTHERWISE STATED IN WRITING THE COPYRIGHT HOLDERS AND/OR OTHER PARTIES PROVIDE THE LIBRARY "AS IS" WITHOUT WARRANTY OF ANY KIND, EITHER EXPRESSED OR IMPLIED, INCLUDING, BUT NOT LIMITED TO, THE IMPLIED WARRANTIES OF MERCHANTABILITY AND FITNESS FOR A PARTICULAR PURPOSE. THE ENTIRE RISK AS TO THE QUALITY AND PERFORMANCE OF THE LIBRARY IS WITH YOU. SHOULD THE LIBRARY PROVE DEFECTIVE, YOU ASSUME THE COST OF ALL NECESSARY SERVICING, REPAIR OR CORRECTION.

16. IN NO EVENT UNLESS REQUIRED BY APPLICABLE LAW OR AGREED TO IN WRITING WILL ANY COPYRIGHT HOLDER, OR ANY OTHER PARTY WHO MAY MODIFY AND/OR REDISTRIBUTE THE LIBRARY AS PERMITTED ABOVE, BE LIABLE TO YOU FOR DAMAGES, INCLUDING ANY GENERAL, SPECIAL, INCIDENTAL OR CONSEQUENTIAL DAMAGES ARISING OUT OF THE USE OR INABILITY TO USE THE LIBRARY (INCLUDING BUT NOT LIMITED TO LOSS OF DATA OR DATA BEING RENDERED INACCURATE OR LOSSES SUSTAINED BY YOU OR THIRD PARTIES OR A FAILURE OF THE LIBRARY TO OPERATE WITH ANY OTHER SOFTWARE), EVEN IF SUCH HOLDER OR OTHER PARTY HAS BEEN ADVISED OF THE POSSIBILITY OF SUCH DAMAGES.

END OF TERMS AND CONDITIONS

How to apply these terms to your new libraries

If you develop a new library, and you want it to be of the greatest possible use to the public, we recommend making

it free software that everyone can redistribute and change. You can do so by permitting redistribution under these terms (or, alternatively, under the terms of the ordinary General Public License).

To apply these terms, attach the following notices to the library. It is safest to attach them to the start of each source file to most effectively convey the exclusion of warranty; and each file should have at least the "copyright" line and a pointer to where the full notice is found.

one line to give the library's name and a brief idea of what it does.

Copyright (C) <year> <name of author>

This library is free software; you can redistribute it and/or modify it under the terms of the GNU Lesser General Public License as published by the Free Software Foundation; either version 2.1 of the license, or (at your option) any later version.

This library is distributed in the hope that it will be useful, but WITHOUT ANY WARRANTY; without even the implied warranty of MERCHANTABILITY or FITNESS FOR A PARTICULAR PURPOSE. See the GNU Lesser General Public License for more details.

You should have received a copy of the GNU Lesser General Public License along with this library; if not, write to the Free Software Foundation, Inc., 51 Franklin Street, Fifth Floor, Boston, MA 02110-1301 USA

Also add information on how to contact you by electronic and paper mail.

You should also get your employer (if you work as a programmer) or your school, if any, to sign a "copyright disclaimer" for the library, if necessary. Here is a sample; alter the names:

Yoyodyne, Inc., hereby disclaims all copyright interest in the library 'Frob' (a library for tweaking knobs) written by James Random Hacker.

signature of Ty Coon, 1 April 1990
Ty Coon, President of Vice

MOZILLA PUBLIC LICENSE

Version 1.1

1. Definitions.

- 1.0.1. "Commercial use" means distribution or otherwise making the covered code available to a third party.
- 1.1. "Contributor" means each entity that creates or contributes to the creation of modifications.
- 1.2. "Contributor version" means the combination of the original code, prior modifications used by a contributor, and the modifications made by that particular contributor.
- 1.3. "Covered code" means the original code or modifications or the combination of the original code and modifications, in each case including portions thereof.
- 1.4. "Electronic distribution mechanism" means a mechanism generally accepted in the software development community for the electronic transfer of data.
- 1.5. "Executable" means covered code in any form other than source code.
- 1.6. "Initial developer" means the individual or entity identified as the initial Developer in the Source Code notice required by exhibit A.
- 1.7. "Larger work" means a work which combines covered code or portions thereof with code not governed by the terms of this License.
- 1.8. "License" means this document.
- 1.8.1. "Licensable" means having the right to grant, to the maximum extent possible, whether at the time of the initial grant or subsequently acquired, any and all of the rights conveyed herein.
- 1.9. "Modifications" means any addition to or deletion from the substance or structure of either the original code or any previous modifications. When covered code is released as a series of files, a modification is:
 - A. Any addition to or deletion from the contents of a file containing original code or previous modifications.
 - B. Any new file that contains any part of the original code or previous modifications.
- 1.10. "Original code" means source code of computer software code which is described in the source code notice required by exhibit as original code, and

which, at the time of its release under this license is not already covered code governed by this license.

- 1.10.1. "Patent claims" means any patent claim(s), now owned or hereafter acquired, including without limitation, method, process, and apparatus claims, in any patent licensable by grantor.
- 1.11. "Source code" means the preferred form of the covered code for making modifications to it, including all modules it contains, plus any associated interface definition files, scripts used to control compilation and installation of an executable, or source code differential comparisons against either the original code or another well known, available covered code of the contributor's choice. The source code can be in a compressed or archival form, provided the appropriate decompression or de-archiving software is widely available for no charge.
- 1.12. "You" (or "Your") means an individual or a legal entity exercising rights under, and complying with all of the terms of, this license or a future version of this license issued under section 6.1. For legal entities, "You" includes any entity which controls, is controlled by, or is under common control with You. For purposes of this definition, "control" means (a) the power, direct or indirect, to cause the direction or management of such entity, whether by contract or otherwise, or (b) ownership of more than fifty percent (50%) of the outstanding shares or beneficial ownership of such entity.

2. Source Code License.

- 2.1. The initial developer grant.
The initial developer hereby grants You a world-wide, royalty-free, non-exclusive license, subject to third party intellectual property claims:
 - a) under intellectual property rights (other than patent or trademark) licensable by initial developer to use, reproduce, modify, display, perform, sublicense and distribute the original code (or portions thereof) with or without modifications, and/or as part of a larger work; and
 - b) under patents claims infringed by the making, using or selling of original code, to make, have made, use, practice, sell, and offer for sale, and/or otherwise dispose of the original code (or portions thereof).

- (c) the licenses granted in this section 2.1(a) and (b) are effective on the date Initial developer first distributes original code under the terms of this license.
- (d) Notwithstanding section 2.1(b) above, no patent license is granted: 1) for code that You delete from the original Code; 2) separate from the original code; or 3) for infringements caused by:
 - i) the modification of the original code or ii) the combination of the original code with other software or devices.

2.2. Contributor Grant.

Subject to third party intellectual property claims, each contributor hereby grants You a world-wide, royalty-free, non-exclusive license

- (a) under intellectual property rights (other than patent or trademark) licensable by contributor, to use, reproduce, modify, display, perform, sublicense and distribute the modifications created by such contributor (or portions thereof) either on an unmodified basis, with other modifications, as covered code and/or as part of a larger work; and
- (b) under patent claims infringed by the making, using, or selling of modifications made by that contributor either alone and/or in combination with its contributor version (or portions of such combination), to make, use, sell, offer for sale, have made, and/or otherwise dispose of: 1) modifications made by that contributor (or portions thereof); and 2) the combination of modifications made by that contributor with its contributor version (or portions of such combination).
- (c) the licenses granted in sections 2.2(a) and 2.2(b) are effective on the date contributor first makes commercial use of the covered code.
- (d) Notwithstanding section 2.2(b) above, no patent license is granted: 1) for any code that contributor has deleted from the contributor version; 2) separate from the contributor version; 3) for infringements caused by: i) third party modifications of contributor version or ii) the combination of modifications made by that contributor with other software (except as part of the contributor version) or other devices; or 4) under patent claims infringed by covered code in the absence of modifications made by that contributor.

3. Distribution Obligations.

3.1. Application of license.

The modifications which You create or to which you contribute are governed by the terms of this license, including without limitation section 2.2. The source code version of covered code may be distributed only under the terms of this license or a future version of this license released under section 6.1, and you must include a copy of this license with every copy of the source code you distribute. You may not

offer or impose any terms on any source code version that alters or restricts the applicable version of this license or the recipients' rights hereunder. However, you may include an additional document offering the additional rights described in section 3.5.

3.2. Availability of source code.

Any modification which you create or to which you contribute must be made available in source code form under the terms of this license either on the same media as an executable version or via an accepted electronic distribution mechanism to anyone to whom you made an executable version available; and if made available via electronic distribution mechanism, must remain available for at least twelve (12) months after the date it initially became available, or at least six (6) months after a subsequent version of that particular modification has been made available to such recipients. You are responsible for ensuring that the source code version remains available even if the electronic distribution mechanism is maintained by a third party.

3.3. Description of modifications.

You must cause all covered code to which you contribute to contain a file documenting the changes You made to create that covered code and the date of any change. You must include a prominent statement that the modification is derived, directly or indirectly, from original code provided by the initial developer and including the name of the initial developer in (a) the source code, and (b) in any notice in which you describe the origin or ownership of the covered code.

3.4. Intellectual property matters

(a) Third party claims.

If contributor has knowledge that a license under a third party's intellectual property rights is required to exercise the rights granted by such contributor under sections 2.1 or 2.2, contributor must include a text file with the source code distribution titled "LEGAL" which describes the claim and the party making the claim in sufficient detail that a recipient will know whom to contact. If contributor obtains such knowledge after the modification is made available as described in section 3.2, contributor shall promptly modify the LEGAL file in all copies contributor makes available thereafter and shall take other steps (such as notifying appropriate mailing lists or newsgroups) reasonably calculated to inform those who received the covered code that new knowledge has been obtained.

(b) Contributor APIs.

If contributor's modifications include an application programming interface and contributor has knowledge of patent licenses which are reasonably necessary to implement that API, contributor must also include this information in the LEGAL file.

(c) Representations.

contributor represents that, except as disclosed pursuant to section 3.4(a) above, contributor believes that contributor's modifications are contributor's original creation(s) and/or contributor has sufficient rights to grant the rights conveyed by this license.

3.5. Required notices.

You must duplicate the notice in exhibit A in each file of the source code. If it is not possible to put such notice in a particular source code file due to its structure, then You must include such notice in a location (such as a relevant directory) where a user would be likely to look for such a notice. If You created one or more modification(s), you may add your name as a contributor to the notice described in exhibit A. you must also duplicate this license in any documentation for the source code where You describe recipients' rights or ownership rights relating to covered code. You may choose to offer, and to charge a fee for, warranty, support, indemnity or liability obligations to one or more recipients of covered code. However, you may do so only on your own behalf, and not on behalf of the Initial developer or any contributor. You must make it absolutely clear than any such warranty, support, indemnity or liability obligation is offered by you alone, and You hereby agree to indemnify the Initial developer and every contributor for any liability incurred by the Initial developer or such contributor as a result of warranty, support, indemnity or liability terms you offer.

3.6. Distribution of executable versions.

You may distribute covered code in executable form only if the requirements of section 3.1-3.5 have been met for that covered code, and if you include a notice stating that the source code version of the covered code is available under the terms of this license, including a description of how and where you have fulfilled the obligations of section 3.2. The notice must be conspicuously included in any notice in an executable version, related documentation or collateral in which you describe recipients' rights relating to the covered code. You may distribute the executable version of covered code or ownership rights under a license of your choice, which may contain terms different from this license, provided that you are in compliance with the terms of this license and that the license for the executable version does not attempt to limit or alter the recipient's rights in the source code version from the rights set forth in this license. If you distribute the executable version under a different license you must make it absolutely clear that any terms which differ from this license are offered by you alone, not by the Initial developer or any contributor. You hereby agree to indemnify the initial developer and every contributor for any liability incurred by the initial developer or such contributor as a result of any such terms You offer.

3.7. Larger works.

You may create a larger work by combining covered

code with other code not governed by the terms of this license and distribute the larger work as a single product. In such a case, you must make sure the requirements of this license are fulfilled for the covered code.

4. Inability to comply due to statute or regulation.

If it is impossible for you to comply with any of the terms of this license with respect to some or all of the covered code due to statute, judicial order, or regulation then you must: (a) comply with the terms of this license to the maximum extent possible; and (b) describe the limitations and the code they affect. Such description must be included in the LEGAL file described in section 3.4 and must be included with all distributions of the source code. Except to the extent prohibited by statute or regulation, such description must be sufficiently detailed for a recipient of ordinary skill to be able to understand it.

5. Application of this license.

This license applies to code to which the initial developer has attached the notice in exhibit A and to related covered code.

6. Versions of the license.

6.1. New versions.

Netscape communications corporation ("Netscape") may publish revised and/or new versions of the license from time to time. Each version will be given a distinguishing version number.

6.2. Effect of new versions.

Once covered code has been published under a particular version of the license, you may always continue to use it under the terms of that version. You may also choose to use such covered code under the terms of any subsequent version of the license published by netscape. No one other than netscape has the right to modify the terms applicable to covered code created under this license.

6.3. Derivative works.

If You create or use a modified version of this license (which you may only do in order to apply it to code which is not already covered code governed by this license), You must (a) rename Your license so that the phrases "Mozilla", "MOZILLAPL", "MOZPL", "Netscape", "MPL", "NPL" or any confusingly similar phrase do not appear in your license (except to note that your license differs from this license) and (b) otherwise make it clear that Your version of the license contains terms which differ from the Mozilla Public license and netscape Public License. (Filling in the name of the initial developer, original code or contributor in the notice described in exhibit A shall not of themselves be deemed to be modifications of this license.)

APPENDIX

7. DISCLAIMER OF WARRANTY.

COVERED CODE IS PROVIDED UNDER THIS LICENSE ON AN "AS IS" BASIS, WITHOUT WARRANTY OF ANY KIND, EITHER EXPRESSED OR IMPLIED, INCLUDING, WITHOUT LIMITATION, WARRANTIES THAT THE COVERED CODE IS FREE OF DEFECTS, MERCHANTABLE, FIT FOR A PARTICULAR PURPOSE OR NON-INFRINGEMENT. THE ENTIRE RISK AS TO THE QUALITY AND PERFORMANCE OF THE COVERED CODE IS WITH YOU. SHOULD ANY COVERED CODE PROVE DEFECTIVE IN ANY RESPECT, YOU (NOT THE INITIAL DEVELOPER OR ANY OTHER CONTRIBUTOR) ASSUME THE COST OF ANY NECESSARY SERVICING, REPAIR OR CORRECTION. THIS DISCLAIMER OF WARRANTY CONSTITUTES AN ESSENTIAL PART OF THIS LICENSE. NO USE OF ANY COVERED CODE IS AUTHORIZED HEREUNDER EXCEPT UNDER THIS DISCLAIMER.

8. TERMINATION.

8.1. This license and the rights granted hereunder will terminate automatically if you fail to comply with terms herein and fail to cure such breach within 30 days of becoming aware of the breach. All sublicenses to the covered code which are properly granted shall survive any termination of this license. Provisions which, by their nature, must remain in effect beyond the termination of this license shall survive.

8.2. If you initiate litigation by asserting a patent infringement claim (excluding declaratory judgment actions) against initial developer or a contributor (the initial developer or contributor against whom you file such action is referred to as "Participant") alleging that:

(a) such participant's contributor version directly or indirectly infringes any patent, then any and all rights granted by such participant to you under sections 2.1 and/or 2.2 of this license shall, upon 60 days notice from Participant terminate prospectively, unless if within 60 days after receipt of notice you either: (i) agree in writing to pay participant a mutually agreeable reasonable royalty for your past and future use of modifications made by such participant, or (ii) withdraw your litigation claim with respect to the contributor version against such participant. If within 60 days of notice, a reasonable royalty and payment arrangement are not mutually agreed upon in writing by the parties or the litigation claim is not withdrawn, the rights granted by participant to you under sections 2.1 and/or 2.2 automatically terminate at the expiration of the 60 day notice period specified above.

(b) any software, hardware, or device, other than such participant's contributor Version, directly or indirectly infringes any patent, then any rights granted

to You by such participant under sections 2.1(b) and 2.2(b) are revoked effective as of the date you first made, used, sold, distributed, or had made, modifications made by that participant.

8.3. If you assert a patent infringement claim against participant alleging that such participant's contributor version directly or indirectly infringes any patent where such claim is resolved (such as by license or settlement) prior to the initiation of patent infringement litigation, then the reasonable value of the licenses granted by such participant under sections 2.1 or 2.2 shall be taken into account in determining the amount or value of any payment or license.

8.4. In the event of termination under sections 8.1 or 8.2 above, all end user license agreements (excluding distributors and resellers) which have been validly granted by you or any distributor hereunder prior to termination shall survive termination.

9. LIMITATION OF LIABILITY.

UNDER NO CIRCUMSTANCES AND UNDER NO LEGAL THEORY, WHETHER TORT (INCLUDING NEGLIGENCE), CONTRACT, OR OTHERWISE, SHALL YOU, THE INITIAL DEVELOPER, ANY OTHER CONTRIBUTOR, OR ANY DISTRIBUTOR OF COVERED CODE, OR ANY SUPPLIER OF ANY OF SUCH PARTIES, BE LIABLE TO ANY PERSON FOR ANY INDIRECT, SPECIAL, INCIDENTAL, OR CONSEQUENTIAL DAMAGES OF ANY CHARACTER INCLUDING, WITHOUT LIMITATION, DAMAGES FOR LOSS OF GOODWILL, WORK STOPPAGE, COMPUTER FAILURE OR MALFUNCTION, OR ANY AND ALL OTHER COMMERCIAL DAMAGES OR LOSSES, EVEN IF SUCH PARTY SHALL HAVE BEEN INFORMED OF THE POSSIBILITY OF SUCH DAMAGES. THIS LIMITATION OF LIABILITY SHALL NOT APPLY TO LIABILITY FOR DEATH OR PERSONAL INJURY RESULTING FROM SUCH PARTY'S NEGLIGENCE TO THE EXTENT APPLICABLE LAW PROHIBITS SUCH LIMITATION. SOME JURISDICTIONS DO NOT ALLOW THE EXCLUSION OR LIMITATION OF INCIDENTAL OR CONSEQUENTIAL DAMAGES, SO THIS EXCLUSION AND LIMITATION MAY NOT APPLY TO YOU.

10. U.S. GOVERNMENT END USERS.

The covered code is a "commercial item," as that term is defined in 48 C.F.R. 2.101 (Oct. 1995), consisting of "commercial computer software" and "commercial computer software documentation," as such terms are used in 48 C.F.R. 12.212 (Sept. 1995). Consistent with 48 C.F.R. 12.212 and 48 C.F.R. 227.7202-1 through 227.7202-4 (June 1995), all U.S. Government end users acquire covered code with only those rights set forth herein.

11. MISCELLANEOUS.

This license represents the complete agreement concerning subject matter hereof. If any provision of this license is held to be unenforceable, such provision shall be reformed only to the extent necessary to make it enforceable. This License shall be governed by California law provisions (except to the extent applicable law, if any, provides otherwise), excluding its conflict-of-law provisions. With respect to disputes in which at least one party is a citizen of, or an entity chartered or registered to do business in the united states of america, any litigation relating to this License shall be subject to the jurisdiction of the federal courts of the northern district of california, with venue lying in santa clara county, california, with the losing party responsible for costs, including without limitation, court costs and reasonable attorneys' fees and expenses. The application of the united nations convention on contracts for the International sale of goods is expressly excluded. Any law or regulation which provides that the language of a contract shall be construed against the drafter shall not apply to this license.

12. RESPONSIBILITY FOR CLAIMS.

As between initial developer and the contributors, each party is responsible for claims and damages arising, directly or indirectly, out of its utilization of rights under this license and you agree to work with initial developer and contributors to distribute such responsibility on an equitable basis. Nothing herein is intended or shall be deemed to constitute any admission of liability.

13. MULTIPLE-LICENSED CODE.

Initial developer may designate portions of the covered code as "Multiple-Licensed". "Multiple-Licensed" means that the initial developer permits you to utilize portions of the covered code under your choice of the NPL or the alternative licenses, if any, specified by the initial developer in the file described in exhibit A.

EXHIBIT A -Mozilla Public License.

The contents of this file are subject to the Mozilla Public License Version 1.1 (the "license"); you may not use this file except in compliance with the License. You may obtain a copy of the license at <http://www.mozilla.org/MPL/>

Software distributed under the license is distributed on an "AS IS" basis, WITHOUT WARRANTY OF ANY KIND, either express or implied. See the license for the specific language governing rights and limitations under the License.

The Original Code is _____.

The Initial Developer of the Original Code is _____.

Portions created by _____ are Copyright (C) _____. All Rights Reserved.

Contributor(s): _____.

Alternatively, the contents of this file may be used under the terms of the _____ license (the "[] License"), in which case the provisions of [] license are applicable instead of those above. If you wish to allow use of your version of this file only under the terms of the [] license and not to allow others to use your version of this file under the MPL, indicate your decision by deleting the provisions above and replace them with the notice and other provisions required by the [] license. If you do not delete the provisions above, a recipient may use your version of this file under either the MPL or the [] license."

NOTE: The text of this exhibit A may differ slightly from the text of the notices in the source code files of the original code. You should use the text of this exhibit A rather than the text found in the original code/source code for Your modifications.



The model and serial number of the TV is located on the back and one side of the TV. Record it below should you ever need service.

MODEL _____

SERIAL _____

NETCAST

YAHOO! TV WIDGETS

You can enjoy the best of the Internet in perfect harmony with the simplicity and reliability of your TV. Yahoo! TV Widgets provide an integrated Internet TV experience powered by the Yahoo!® Connected TV platform. You can monitor financial stocks, share photos with friends and family, track news and weather and much more, all through the Yahoo! TV Widgets service on your TV.

Note that these services are provided by the Content Provider, using Yahoo! Widget Platform provided by Yahoo!. All the services are dependent on appropriate Content Provider. Please check about page of each widgets for Terms of service.

Note If you have any question or need any help for the widgets which is not covered in this manual, please contact web site for further help which shall be listed in about page of each widget, or Yahoo! help site <http://connectedtv.yahoo.com/help>.

What is a TV Widget?















A TV Widget is an Internet application designed to run on your TV.

What is a Snippet?

A Snippet is a shortcut used to open a TV Widget, as a dynamic bookmark to TV Widget content.

Using the Remote Control

When Yahoo! TV Widgets are displayed, you can use the following remote control buttons.

	Begin using Yahoo! TV Widgets. Press it again to go back to just watching TV.		Select the focused item.
	Highlight and focus on buttons in the Yahoo! TV Widgets user interface.		Go to the TV Menu.
	Move the focus selection up.		Close the open widget and return to watching TV.
	Move the focus selection down.		Change the open widget's settings.
	Move the focus selection to the left.		Add, move, or delete your snippets.
	Move the focus selection to the right.		Resize the video to fit onscreen, or to make it fullscreen.
	Return to the previous menu.		Return to TV viewing.

Getting Started Out of the Box

Once your television is powered up and your network is operational, the Yahoo! TV Widgets software guides you through its step-by-step on-screen wizard the first time you startup. These setup steps are designed to provide you with the information and settings you'll need to start using the Yahoo! TV Widgets user interface.

Guided Setup



Activate Yahoo! TV Widgets. The first time you use Yahoo! TV Widgets the step-by-step wizard begins with the Welcome Screen.



1 Select Let's get started!. If you select Exit Setup now, this step will be resumed the next time you press WIDGETS.

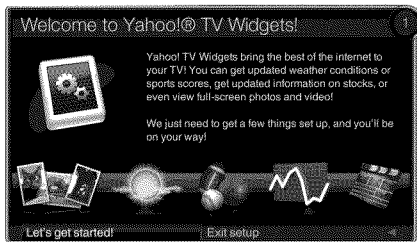

2 Choosing your country allows the use of localized content.



Navigate to your location.



Select your country.

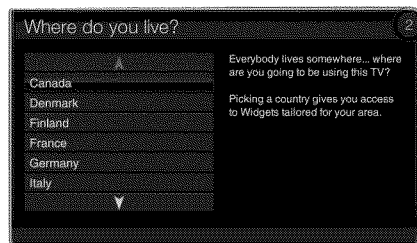

3 Accepting the Yahoo! Privacy Policy is required to use Yahoo! Widgets.



Select Ok, I accept.

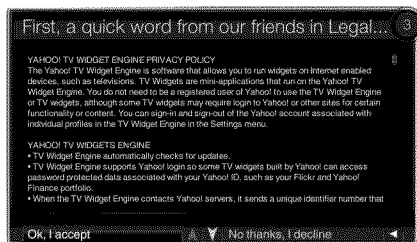

4 Accepting Yahoo! Terms of Service is also required to use Yahoo! TV Widgets.



Select Ok, I accept.

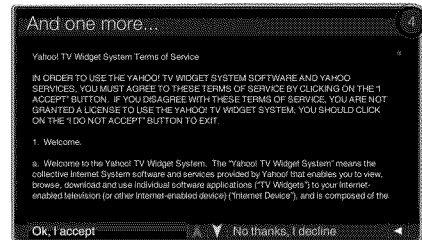

5 Enter your name to setup your profile.

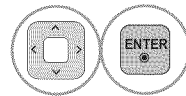

Select letters and spell your name.

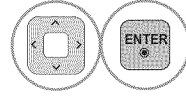

Select Save this name and create your profile.

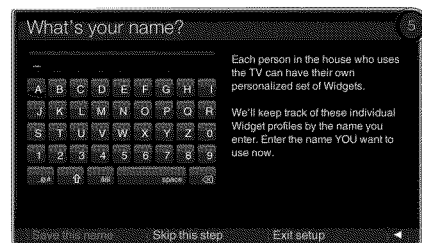

6 Test your network connection. After setup is completed, a tutorial on how to use Yahoo! TV Widgets will come up next.



Select Continue and review the tutorial. Select Exit setup to start using Yahoo! Widgets now.

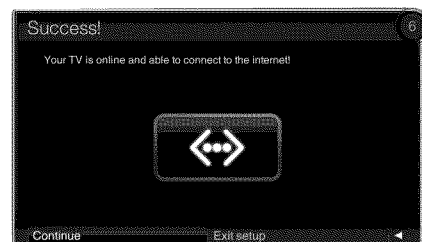

Using Yahoo! TV Widgets



- Activate Yahoo! TV Widgets.
- The horizontal list at the bottom of your TV screen is called "**the dock**".
 - The items in this list are called "**snippets**".
 - A snippet is a shortcut which opens a TV Widget.

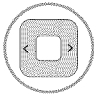

- Move between snippets.
- Focus is located in the leftmost region (high-lighted in dark red).
 - The dock scrolls snippets under this focal point.



- Open the **Sidebar** when the TV Widget snippet is in focus.
- The Home button including the main logo is at the top of the sidebar.

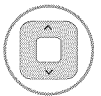

- Navigate a menu item.
- The currently focused button is the one high-lighted in dark red.



- Select the focused button.

The sidebar's bottom toolbar includes four color-coded buttons.



RED	Close the sidebar and return to watching TV.	YELLOW	Add or delete a snippet.
GREEN	Change the widget's settings.	BLUE	Resize video to fit onscreen, or to make it fullscreen.

Using the Profile Widget

- The **Profile Widget** configures your user profile.
- You can set up multiple profiles for multiple users.
- Each profile maintains its own list of TV Widgets.
- The **Switch Profile** menu allows you to switch to a different user profile.
- The **Profile Settings** menu allows you to customize your profile, create a profile PIN, or limit the installation of widgets.
- The **System Settings** menu allows you to change your **Location**, **Repeat the Tutorial**, and **Restore Factory Settings**.
- **Restore Factory Settings** will erase all profiles and widgets installed by users, and restore the original configuration. (See also **NetCast** → **Setup** → **Service maintenance** → **Restore Yahoo! Factory Settings**)
- The **Administrative Controls** menu allows you to set the **Screen Saver** timeout, create the **Owner PIN**, and to **Create a Profile**.
- The **Sign in to Yahoo!** menu allows you to personalize your experience using your Yahoo! ID.
- If you don't have a Yahoo! ID yet, please visit <http://www.yahoo.com> to create one.

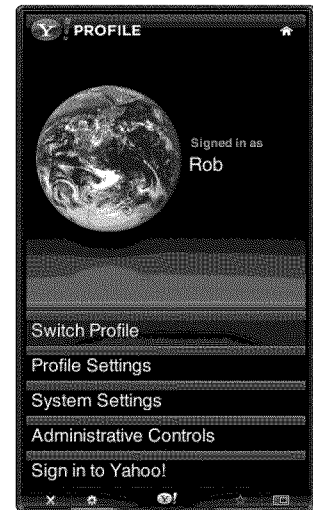

Using the Widget Gallery

- The **Widget Gallery** allows you to browse and discover new TV Widgets.
- The featured TV Widgets are highlighted in the display case at the top of the sidebar.
- You can also browse available TV Widgets by category.
- To install a widget, select **Add Widget to My Profile** and press the ENTER button.
- The **Owner PIN** is needed to install widgets for profiles that have been protected through the **Limit Profile** indicator under **Profile Widget** → **Profile Settings**.
- Go to the **Profile Widget** → **Administrative Controls** menu to set or change the **Owner PIN**.
- The maximum number of Widget which can be installed is 10.
- You can delete the Widget by pressing the RED button after YELLOW button in Dock setting.



Using the Yahoo! News Widget

- The **Yahoo! News Widget** provides the latest headline news for business, entertainment, politics, sports, top stories, and many other categories.
- Select a category, press **ENTER**.
- Select a headline within the category, press **ENTER**.
- View the dynamically updated news summary for the selected headline.



Using the Yahoo! Weather Widget

- The **Yahoo! Weather Widget** provides updates on your local and favorite weather locations with content that dynamically changes with weather conditions.
- Press the **GREEN** button to display the **Settings** menu.
- From the **Settings** menu you can add or remove a city for which you want to view weather information.
 - **Add a New City** by entering the name of the city. Once the search results are displayed, select the city you want and press **ENTER** button.
 - **Delete a City** by selecting the city you want to delete from the city list. Press **ENTER** button and confirm the deletion.
 - Select the Display Units As button to change the temperature indication mode to **Imperial** or **Metric**. **Imperial** will show temperatures in Fahrenheit and **Metric** will use Celsius.
- To create a snippet for a favorite city:
 - Select the city from the home page and view the detailed weather information.
 - Press the **YELLOW** button.
 - Select the **Add Snippet** button and press **ENTER** to add the city as a snippet.
- To delete a snippet for a city:
 - Navigate to the snippet and press **ENTER** button to start the widget. The detailed page for the snippet's city will be displayed.
 - Press the **YELLOW** button.
 - Select the Delete Snippet button and press **ENTER** button to remove the snippet.



Using the Yahoo! Finance Widget

- View stock information and the latest stock news with the Yahoo! Finance Widget.
- Press the **GREEN** button to set up your stocks.
 - Use the **Add New Symbol** menu to enter the name of a new stock.
 - Select the stock you want to add from the search results and select the **Add Symbol** button and press **ENTER** button.
 - The selected stock is added to the **My Stocks** list.
 - The **Import Symbols From Yahoo!** menu retrieves the stocks from your Yahoo! Finance portfolio.
 - The **Merge Symbols** button merges the symbols in the Yahoo! Finance Widget with the symbols from your portfolio.
 - The **Replace Symbols** button deletes the symbols in the Yahoo! Finance Widget and replaces them with the symbols from your portfolio.
 - The **Display Format** button changes the stock-price fluctuation transition to **Value** or **Percentage**.
- To create a snippet for a favorite stock:
 - Select the stock symbol from the home page and view the detailed finance information.
 - Press the **YELLOW** button.
 - Select the **Add Snippet** button and press **ENTER** button to add the stock as a snippet.
- To delete a snippet:
 - Navigate to the snippet and press **ENTER** button to start widget. The detailed page for the snippet's stock will be displayed.
 - Press the **YELLOW** button.
 - Select the **Delete Snippet** button and press **ENTER** button to remove the snippet.

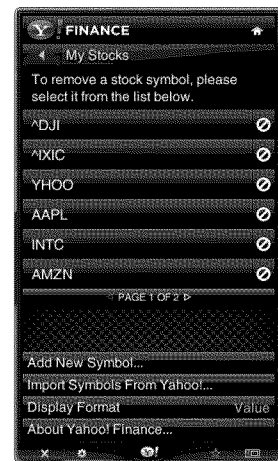

Using the flickr Widget



- The **flickr Widget** provides a television-viewing experience while watching slideshows of family and friends' photos.
- Personalize the **flickr Widget** by logging in with your Yahoo! ID. Refer to **Using the Profile Widget** for instructions.
- The **Your Photos** menu shows photos you have registered with the flickr website.
- The **Your Sets** menu allows you to view photos you have classified in flickr.
- The **Explore** menu allows you to explore photos featured by the flickr website.
- The **Mark as Favorite** moves photos to your **Favorite Photos** set.
- The **Favorite Photos** menu allows you to see the photos you have classified as favorites.
- The **Your Contacts** menu allows you to see updates from family and friends.
- The **Your Groups** menu allows you to select your favorite groups from the flickr website <http://www.flickr.com> to share and enjoy photos with the flickr community of users.
- To view photos in a slideshow:
 - Select a thumbnail of a photo and press **ENTER** button to view the photo's details.
 - Select **Start Slideshow** and press **ENTER** button.
- To control the slideshow display:
 - Press **ENTER** button during a slideshow.
 - The thumbnails of photos are displayed on the bottom of the screen.
 - When the slideshow control is displayed, you can **Pause**, **Play**, and **Stop** the slideshow.
 - If you select the **INFO** button and press **ENTER** button, you can view details for the selected photo.
- To configure the **Settings**, press the **GREEN** button.
 - The **Time Per Slide** button controls the speed of the slideshow.
 - The **Repeat** button will restart the slideshow at the beginning after the last photo is shown.

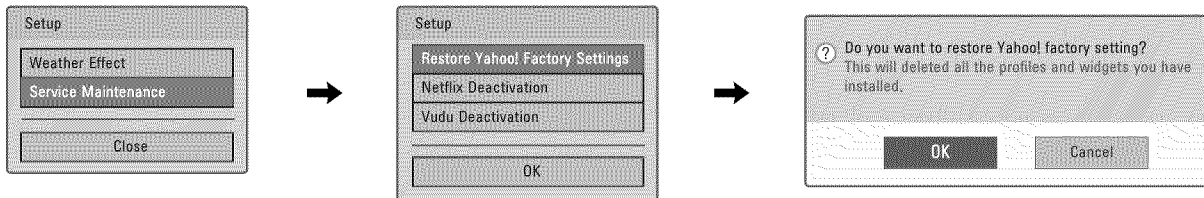

Restore Yahoo! Factory Settings

Restoring Yahoo! Factory Settings will delete all of your profiles and installed widgets.

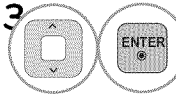
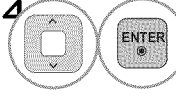
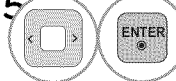

- 1  Display **NetCast** menu.
- 2  Select **Setup** option.
- 3  Select **Service Maintenance**.
- 4  Select **Restore Yahoo! Factory Settings**.
- 5  Select **OK** to restore Yahoo! factory settings. This TV will restore Yahoo! factory settings.

Troubleshooting

Yahoo! TV Widgets Problems	
Misc.-Caption, Language displayed within Widget	<p>Did the customer change Menu language but Widget did not change its language.</p> <ul style="list-style-type: none"> ■ Some Widgets do not fully support TV Menu options. ■ The help site for individual widget can be found in the settings panel of each widget by pressing the GREEN button on your remote after opening that widget from the Dock.

Yahoo! TV Widgets Problems		
Failed to launch Yahoo! TV Widgets	Was the customer watching HDMI input?	<ul style="list-style-type: none"> ■ To use Yahoo! TV Widgets while using the HDMI input, turn off "Simplink-on" in the OPTION menu. Or change to another Input and press then press the WIDGETS button.
	Was the customer watching My Media?	<ul style="list-style-type: none"> ■ The WIDGETS button is blocked when using MY MEDIA. ■ Exit MY MEDIA by pressing the NETCAST button and then select Yahoo!
	Nothing happens when pressing WIDGETS button	<ul style="list-style-type: none"> ■ Turn off the TV and then turn it back on. Press the NETCAST button and then the RED button. Select "Restore Yahoo! Factory Settings" to restore the Yahoo! Factory Settings. ■ For more help, visit the Yahoo! help site: http://connectedtv.yahoo.com/help.
Failed to open some widgets	Is "Loading" message displayed?	<ul style="list-style-type: none"> ■ If the "Loading" message does not go away after a reasonable amount of time, delete that widget and re-install it.
	Check IP Address setting is OK?	<ul style="list-style-type: none"> ■ Make sure the TV can connect to the internet.
	Is Connection Unavailable icon (yellow triangle) displayed on snippet?	<ul style="list-style-type: none"> ■ If connection unavailable icon is displayed, the server may under maintenance or unreachable for other reasons. Try again later or visit the Yahoo! help site. http://connectedtv.yahoo.com/help
	Some Widgets work properly while others do not.	<ul style="list-style-type: none"> ■ Try again later. ■ Try re-installing the Widget. Delete that widget by pressing the Yellow button when it's highlighted in the dock. Then press the Red button twice to delete that widget. Then open the Widget Gallery and browse to find that widget and select "Add Widget to My Profile" to install that widget and then try again. ■ If problem still exists, restore Yahoo! factory settings by pressing NETCAST button and RED button on your remote control.
	If it stops in Loading	<ul style="list-style-type: none"> ■ Perform Restore Yahoo! Factory Settings.

Yahoo! TV Widgets Problems		
Widget is stuck if the remote control button is pressed.	Press BACK button and try again later.	<ul style="list-style-type: none"> ■ The error may only be temporary. Exit out and try again.
	Check IP Address setting is OK?	<ul style="list-style-type: none"> ■ If not, connect Network Cable properly and set IP address from Network menu and try again or contact Internet service provider.
	Press RED or WIDGETS button on remote control.	<ul style="list-style-type: none"> ■ Exits Yahoo! TV Widgets by pressing RED button on your remote and re-enter by WIDGETS button.
	Press NETCAST button.	<ul style="list-style-type: none"> ■ Exits Yahoo! TV Widgets by pressing NETCAST button and enter NETFLIX temporarily, and re-enter Yahoo! Widgets by pressing NETCAST button and select Yahoo! ■ If the problem still exists, re-install the Widget. Press the Yellow button with the Widget highlighted in the Dock. Press the Red button twice to delete that widget. Now open the Widget Gallery and browse to find that widget and select "Add Widget to My Profile" to install that widget and then try again. ■ If the problem still exists for all widgets, restore the Yahoo! Factory settings by pressing the NETCAST button and the RED button on your remote control. Select "Restore Yahoo! Factory Settings" to reset.
Gallery - Unable to install widget from gallery	Check IP Address setting is OK?	<ul style="list-style-type: none"> ■ If not, connect Network Cable properly and set IP address from menu-Option and try again or contact Internet service provider.
	Is Lock Icon on right side of "Add Widget to My Profile"?	<ul style="list-style-type: none"> ■ Need Owner PIN to install. If you forgot Owner PIN, contact Yahoo! for further help. http://connectedtv.yahoo.com/help
	"Install completed" but it never worked.	<ul style="list-style-type: none"> ■ Try to re-start Yahoo! TV Widgets after you enter YouTube and exit from YouTube. ■ Or Delete it and re-install it.
Flicker - "We could not find anything to display" message displayed	Is connection unavailable icon (yellow triangle) displayed?	<ul style="list-style-type: none"> ■ If yes, check network settings or contact internet service provider, or try later.
	Did you sign-in Yahoo! account?	<ul style="list-style-type: none"> ■ If yes, you need to upload your photos to Flickr site to display. ■ If not, try again later. The Flickr server may be under maintenance, or contact service provider.

NETFLIX

Your TV's OSD (On Screen Display) may differ slightly from that shown in this manual.

Activating the TV





You can instantly watch movies (quite a few new releases) & TV episodes from Netflix streamed over the internet to your TV.

To become a Netflix member visit: www.netflix.com/LG

Activating your TV establishes a connection between your TV and your Netflix account. You must activate your TV before you can use it to watch movies streamed over the INTERNET from Netflix.

If newer software is needed, a software update screen will automatically appear.

Note that this service is provided by the Content Provider, Netflix. It is dependent on Netflix to provide the data.

-   Select **NETFLIX**.
-   Select **yes-activate instant streaming from Netflix** if you have an existing account.



- no-start my FREE trial: If you have no account, visit <http://www.netflix.com/LG> on your computer.



- Visit the Netflix website on your computer:

www.netflix.com/activate

Enter your Sign in Name and Password to log into your account.



- 4 See the activation code on your TV screen,



Activation Code

Enter this activation code to the Netflix Website and click Activate.

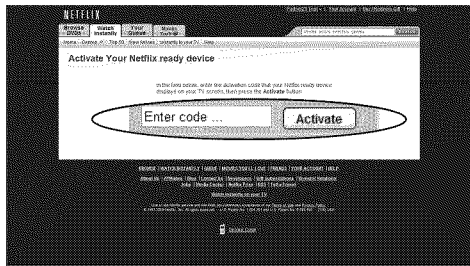

- 5 Wait for the poster screen to appear on your TV.



- 6 You're ready to add movies to your instant Queue.

NETCAST



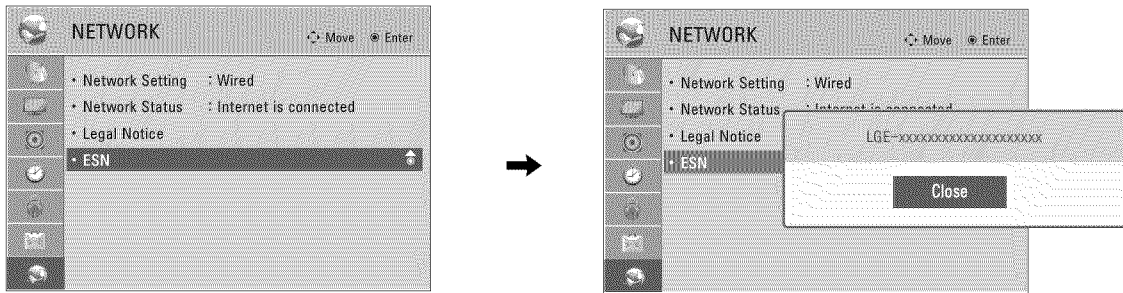

Netflix ESN (Electronic Serial Number)

We provide you the Netflix ESN (Electronic Serial Number) that allows you to watch videos using the Netflix website.

For more information, please visit: www.netflix.com

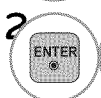

NETCAST

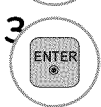
- 1   Select **NETWORK**.
- 2   Select **ESN**.
- 3  See the ESN serial number.

Netflix Deactivation

Once deactivated, TV will no longer instantly stream from your Netflix Instant Queue.

If you deactivate, the TV cannot instantly stream from your Netflix Instant Queue.

If you want, you can activate Netflix later.

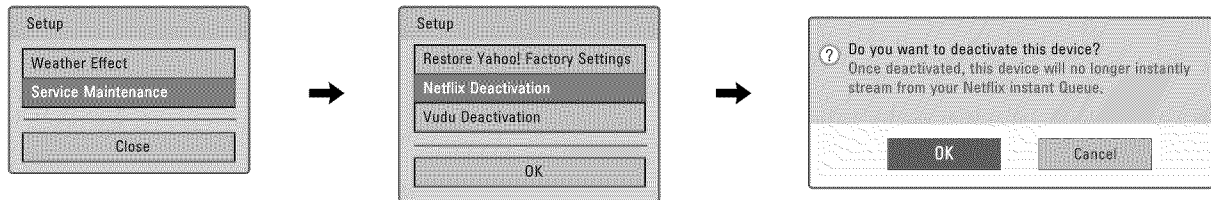

1 Display **NetCast** menu.



2 Select **Setup** option.



3 Select **Service Maintenance**.

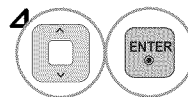

4 Select **Netflix Deactivation**.

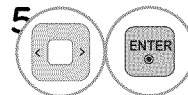

Select **OK** to deactivate the TV. This TV is not currently activated to instantly stream from your Netflix instant Queue.



Activating the TV

In order to make rental/purchase transactions on the Vudu service, a user must create an account on vudu.com. That account is linked to a specific device, via a process called "activation". It is possible to have multiple devices associated with a single Vudu account.

If newer software is needed, a software update screen will automatically appear.

Note that this service is provided by the Content Provider, Vudu. It is dependent on Vudu to provide the data.

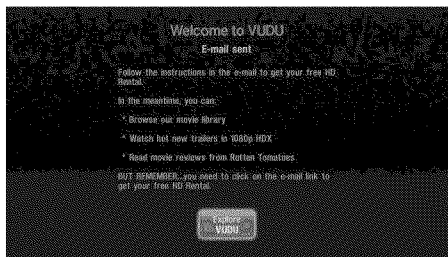
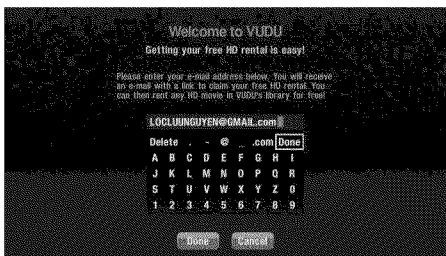
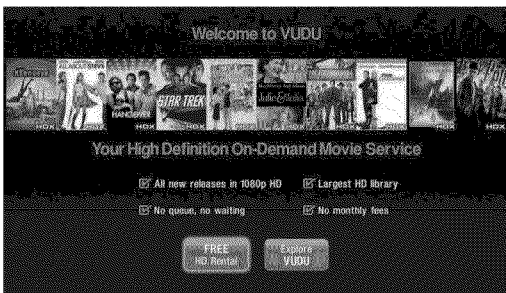

4 You will receive an e-mail with a link.
Click the e-mail link.

5 Create your VUDU account to activate your TV if you no have account.
If you have an existing account, log into your account.

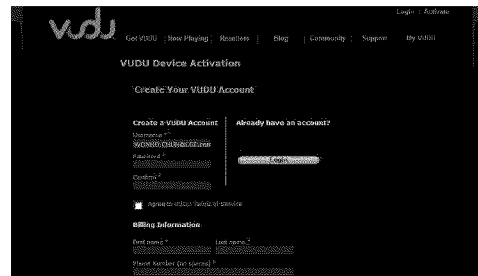

6 Enter your Sign in Email address and Password to log into your account.

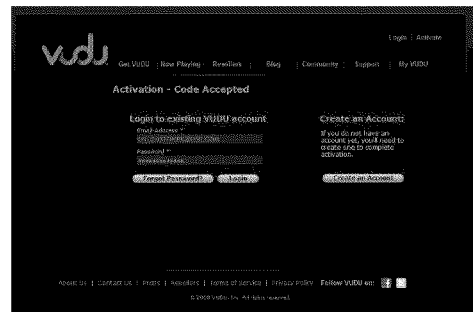

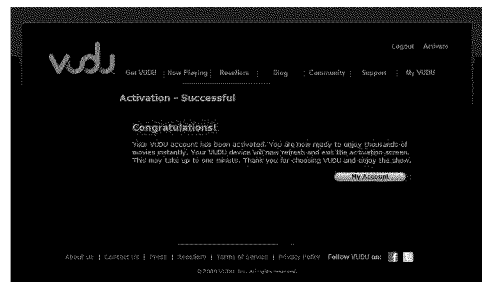

7 Your VUDU account has been activated.

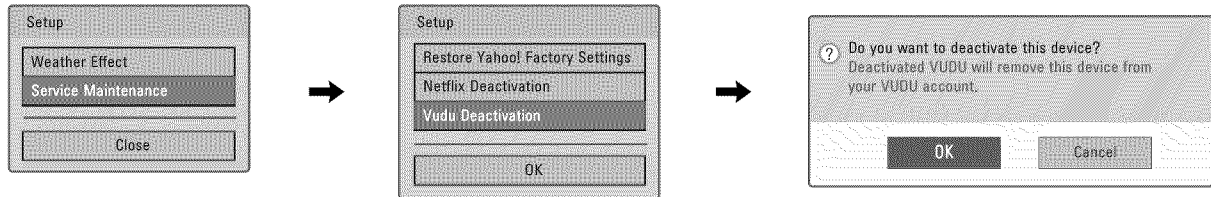

VUDU Deactivation

Once deactivated, this TV will no longer instantly stream from Vudu. If you want, you can activate VUDU later.

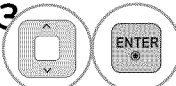
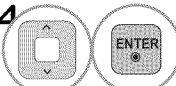
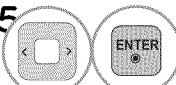

-  Display **NetCast** menu.
-  Select **Setup** option.
-  Select **Service Maintenance**.
-  Select **Vudu Deactivation**.
-  Select **OK** to deactivate the TV.