

Use & Care Guide

Front Load Washer

Guide d'utilisation et d'entretien

Laveuse à chargement frontal

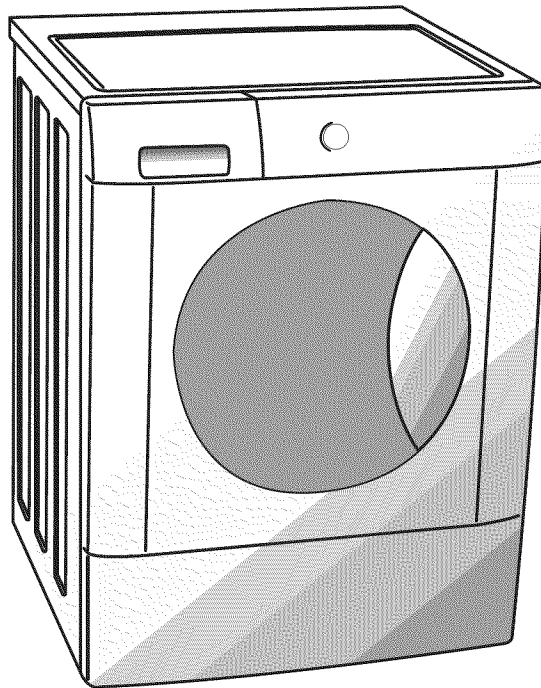

Printed in U.S.A.

Table of Contents

Product Registration.....	2	Winterizing.....	15
Important Safety Instructions	2-3	Common Washing Problems.....	16-17
Washing Procedures.....	4-6	Avoid Service checklist	18-19
Operating Instructions.....	7-10	Warranty	20
Stain Removal Guide.....	11-12	Français	21
Care and Cleaning	13-15		

Product Record

Read and Save These Instructions Record Your Model and Serial Numbers

The model and serial numbers of your washer are found on the washer serial plate located on the washer lid. Record and retain these numbers.

Model Number _____

Serial Number _____

Purchase Date _____

Read all instructions before using this appliance. This book contains valuable information about:

- Operation
- Care
- Service

Keep it in a safe place.

This Use and Care Guide provides general operating instructions for your dryer. It also contains information about features for several other models. Your washer may not have every feature included.

Use the washer only as instructed in this *Use & Care Guide*.

Important Safety Instructions

⚠ WARNING To reduce the risk of fire, electrical shock, or injury to persons when using this washer, comply with the basic warnings listed below. Failure to comply with these warnings could result in serious personal injuries. You can be killed or seriously injured if you don't follow these Important Safety Instructions:

Recognize safety symbols, words and labels

Safety items throughout this manual are labeled with a WARNING or CAUTION based on the risk type as described below:

⚠ WARNING This symbol alerts you to situations that may cause serious body harm, death or property damage.

⚠ CAUTION This symbol alerts you to situations that may cause bodily injury or property damage.

Save these instructions for future reference.

NOTE The instructions appearing in this Use and Care Guide are not meant to cover every possible condition and situation that may occur. Common sense and caution must be practiced when installing, operating and maintaining any appliance.

PREVENT FIRE

- Do not wash items that have been previously cleaned in, soaked in, or spotted with gasoline, cleaning solvents, kerosene, cooking oils, waxes, etc. Do not store these items on or near the washer. These substances give off vapors or chemical reactions that could ignite or explode.
- Do not put oily or greasy rags or clothing on top of the washer. These substances give off vapors that could ignite the materials.
- Do not add gasoline, cleaning solvents, or other flammable or explosive substances to the wash water. These substances give off vapors that could ignite or explode.
- Under certain conditions, hydrogen gas may be produced in a hot water system that has not been used for 2 weeks or more. HYDROGEN GAS IS EXPLOSIVE. If the hot water system has not been used for such a period, before using the washer, turn on all hot water faucets and let the water flow from each for several minutes. This will release any accumulated hydrogen gas. Hydrogen gas is flammable; do not smoke or use an open flame during this time.
- Do not store or use gasoline or other flammable vapors or liquids in the vicinity of this or any other appliance.
- Failure to comply with these warnings could result in fire, explosion, serious bodily injury and/or damage to the rubber or plastic parts of the washer.

Important Safety Instructions, continued

PROTECT CHILDREN

- Do not allow children to play on or in the washer. Close supervision of children is necessary when the washer is used near children. As children grow, teach them the proper, safe use of all appliances.
- Destroy the carton, plastic bag and other packing materials after the washer is unpacked. Children might use them for play. Cartons covered with rugs, bedspreads or plastic sheets can become airtight chambers.
- Keep laundry products out of children's reach. To prevent personal injury, observe all warnings on product labels.
- Before the washer is removed from service or discarded, remove the washer door to prevent accidental entrapment.
- Failure to comply with these warnings could result in serious personal injuries.

PREVENT INJURY

- To prevent shock hazard and assure stability during operation, the washer must be installed and electrically grounded by a qualified service person in accordance with local codes. Installation instructions are packed in the washer for installer's reference. Refer to *INSTALLATION INSTRUCTIONS* for detailed grounding procedures. If the washer is moved to a new location, have it checked and reinstalled by a qualified service person.
- To prevent personal injury or damage to the washer, the electrical power cord of the washer must be plugged into a properly grounded and polarized 3-prong outlet. The third grounding prong must never be removed. Never ground the washer to a gas pipe. Do not use an extension cord or an adaptor plug.
- Follow package directions when using laundry products. Incorrect usage can produce poisonous gas - resulting in serious injury or death.
- Do not combine laundry products for use in 1 load unless specified on the label.
- Do not mix chlorine bleach with ammonia or acids such as vinegar.

⚠ WARNING - HARMFUL VAPOR HAZARD - Do not use or mix liquid chlorine bleach with other household chemicals such as toilet cleaners, rust removers, acid or products containing ammonia. These mixtures can produce dangerous fumes which can cause serious injury or death.



PREVENT INJURY AND DAMAGE TO THE WASHER

To prevent serious personal injury and damage to the washer:

- All repairs and servicing must be performed by an authorized servicer unless specifically recommended in this Use & Care Guide. Use only authorized factory parts.
- Do not tamper with controls.
- Do not install or store the washer where it will be exposed to the weather.
- Do not install on carpet. Install washer on a solid floor. It may be necessary to reinforce the floor to prevent vibration or movement.
- To reduce the risk of electric shock, disconnect this appliance from the power supply before attempting any user maintenance. Turning the controls to the OFF position does not disconnect this appliance from the power supply.
- To prevent injury, do not reach into the washer while parts are moving. Before loading, unloading or adding items, push in the cycle selector knob and allow the drum to coast to a complete stop before reaching inside.
- This washer is equipped with an electrical overload protector. The motor will stop if it becomes overheated. The washer will automatically restart after a cool down period of up to 30 minutes, if the washer has not been manually turned off during this time.
- Failure to comply with these warnings could result in serious personal injuries.

⚠ WARNING - FIRE/ELECTRICAL SHOCK HAZARD -

Avoid fire hazard or electrical shock. Do not use an adaptor plug or extension cord or remove grounding prong from electrical power cord. Failure to follow this warning can cause serious injury, fire or death.

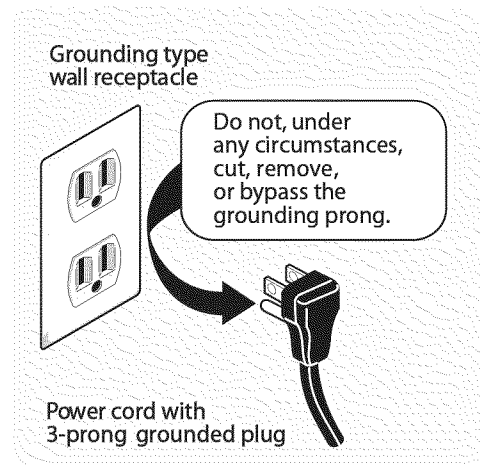

Washing Procedures

⚠ WARNING To reduce the risk of fire, electric shock or injury to persons, read the IMPORTANT SAFETY INSTRUCTIONS in this *Use and Care Guide* before operating your washer.

1 Sort laundry into loads that can be washed together.

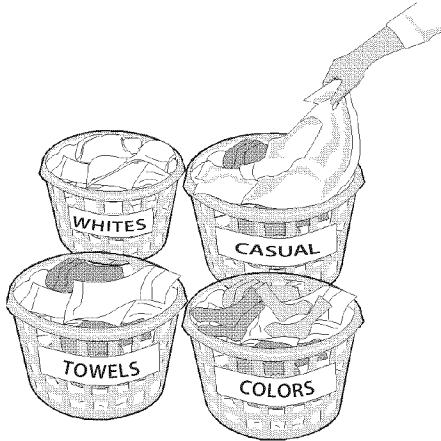

- Sort items by recommended cycle and water temperature.
- Separate white, light and colorfast items from dark and non-colorfast items.
- Separate items that shed lint from items that attract lint. Casual, synthetic, knit, and corduroy items will pick up lint from towels, rugs, and chenille bedspreads.
- Separate heavily soiled items from lightly soiled items.
- Separate lacy, sheer, loosely knit, or delicate items from durable items.
- Do not machine wash items containing fiberglass. Small particles of fiberglass left in the drum may transfer to fabrics in other loads and cause skin irritation.

2 Prepare items for washing.

- Empty pockets.

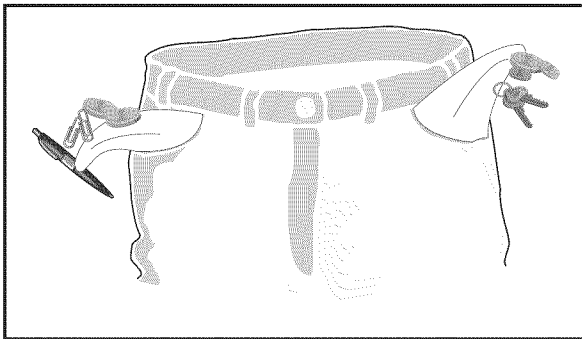

- Brush off lint and dirt. Shake out rugs and beach towels.
- Close zippers, fasten hooks, tie strings and sashes, and remove non-washable trims and ornaments.
- Mend rips and tears to prevent further damage during washing.
- Turn knit items inside out to prevent pilling.

- Place delicate and small items such as bras, hosiery and baby socks in a mesh bag.

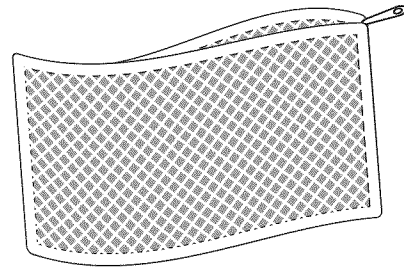

(Mesh bag not included.)

3 Pretreat stains and heavy soil.

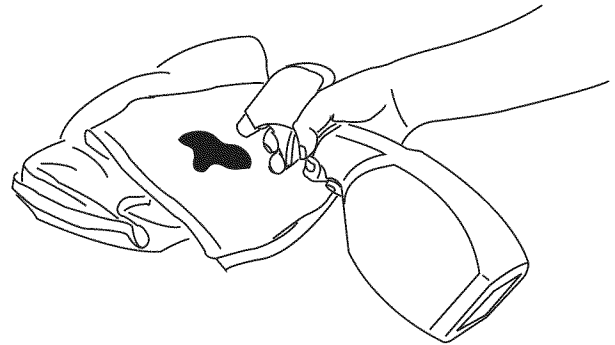

- See Stain Removal Guide in this guide for safe, successful stain removal instructions.

4 Add laundry load to washer.

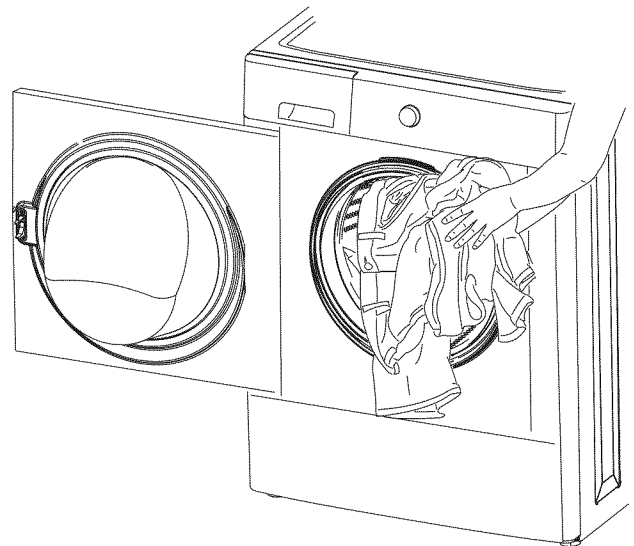

- Combine large and small items in a load.
- Load large items first. Large items should not be more than half the total wash load.
- Washing single items such as a sweater, towel or jeans is inefficient and may cause an out-of-balance load. Add 1 or 2 similar items to help balance the load.
- Wash a single heavy item such as a king-sized comforter, bedspread or sleeping bag separately.
- The washer can be fully loaded, but the items should not be tightly packed. The door should close easily.

Washing Procedures, continued

5 Add laundry products to the dispenser.



For best results

Use a low-sudsing, high efficiency detergent to prevent oversudsing in front load washers. Look for this symbol on the detergent label: 

Detergent, liquid chlorine bleach and liquid fabric softener will be dispensed at the proper times in the cycle.

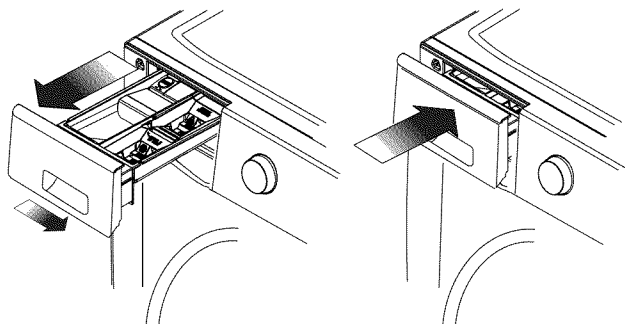

Opening and Closing the Dispenser Drawer

- Slowly open the dispenser drawer by first sliding the safety latch to the right, then pulling the drawer out until it stops.

IMPORTANT Open and close the dispenser drawer slowly. Closing the drawer too quickly could result in early dispensing of the bleach or fabric softener.

Liquid or Powder Detergent

- Use the cap or scoop provided by the detergent manufacturer to measure the amount recommended.
- Detergent dosage may need to be adjusted for water temperature, water hardness, load size and soil level.

Other Wash Products

Color-safe bleach, water conditioner, detergent booster and enzyme products may be added with the detergent. Put liquid products with liquid detergent in the "DETERGENT WASH" chamber or powder products with powder detergent in the "DETERGENT WASH" chamber.

IMPORTANT Do not mix liquids and powders.

NOTE From time to time you may see water in the "LIQUID BLEACH" and "FABRIC SOFTENER" chambers. This is part of the normal operation of the washer.

Liquid Chlorine Bleach

- If desired, add liquid chlorine bleach to the chamber labeled "LIQUID BLEACH" and marked with this symbol .
- Fill to the MIN line for small loads or the MAX line for large loads.
- DO NOT fill above the maximum fill line.

IMPORTANT To prevent fabric damage, do not overfill the "LIQUID BLEACH" chamber or pour liquid chlorine bleach directly onto the load.

- Add color-safe bleach with the detergent.

Liquid Fabric Softener

- If desired, pour the recommended amount of liquid fabric softener into the chamber labeled "FABRIC SOFTENER" and marked with this symbol .
- Fill to the MIN line for small loads or the MAX line for large loads.
- DO NOT fill above the maximum fill line.

NOTE To prevent staining, do not overfill the "FABRIC SOFTENER" chamber or pour liquid fabric softener directly on the wash load.

- Use of a fabric softener-dispensing ball is not recommended in tumble action washers.

6 Select the appropriate cycle and settings for the load.

- Turn the cycle selector knob in either direction to select the cycle desired.
- The estimated cycle time, suitable wash and rinse water temperatures, final spin speed, soil level, and options for each cycle will be indicated for the cycle selected. See the "Washer Settings Chart" for more details.
- To change the settings, press the **TEMP**, **SPIN**, **SOIL**, and **OPTIONS** buttons to scroll to the desired settings.

Washing Procedures, continued

- To select or delete an option, press **OPTIONS**; then, while the indicator is blinking, press **Select**. The indicator will light when the option has been selected. It will no longer be lighted when the option has been deleted.

NOTE To provide the best care for your laundry, not every setting or option is available with every cycle. If a setting or option is not available for the cycle selected, the indicator will not light.

- Adjustments to a cycle will be remembered and recalled each time that cycle is selected in the future.
- To return to factory settings, press the **Pause/Cancel** and **Select** buttons at the same time and hold until the signal sounds.

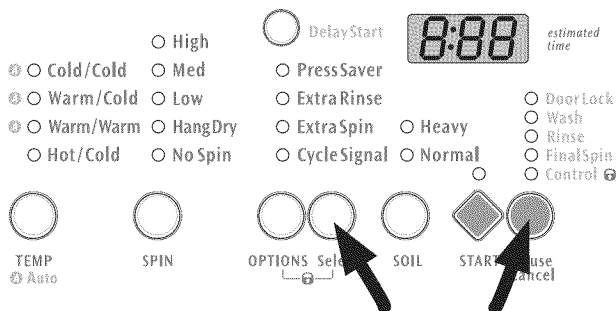

Press and hold both for ten seconds to return to factory settings.

7 Start the washer.

- Close the door and press **START**. The washer will not operate with the door open. "PAU" will be displayed as a reminder to close the door.
- If desired, select **Delay Start** to delay the beginning of the cycle for up to 12 hours. The delay time selected will be displayed as 30, 60 or 90 minutes or 2 through 12 hours.
- As a safety measure, the door will automatically lock during the entire wash cycle and the **Door Lock** indicator will be lighted.
- A forgotten item can be added to the wash drum. Press **Pause/Cancel** once. "PAU" will be displayed alternately with the estimated cycle time. Open the door, add the item, close the door and press **START** to resume the cycle.

- If changes to the settings or options are attempted after the cycle starts, you will hear several beeps when the buttons are pressed. To change the settings or options, press **Pause/Cancel** twice, make the new selections and press **Start** again.
- To change the cycle once the cycle has begun, press **Pause/Cancel** twice, select a new cycle, and press **Start** again. Just turning the cycle selector knob will not change the cycle.
- To stop the cycle, press **Pause/Cancel** twice.

NOTE If the cycle is interrupted during spin, it will take approximately 2-3 minutes for the door lock to release. DO NOT force open the door.

- A signal will sound at the end of the cycle if the **Cycle Signal** option has been selected.
- Remove items from the washer when the cycle ends and place in dryer, line dry or dry flat as directed on the fabric care label.

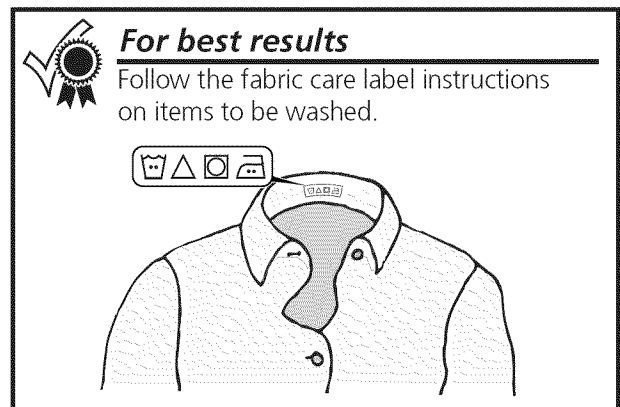

- Excess wrinkling, color transfer or odors may develop in items left in the washer after the cycle has ended, if not removed promptly.

CAUTION - **ENTRAPMENT and TIP-OVER HAZARD** - Do not leave the door open if there are small children or pets present. An open door could entice children to hang on the door or crawl inside the washer. If there are no small children present, you may leave the door ajar to prevent odor build up.

OPERATING INSTRUCTIONS

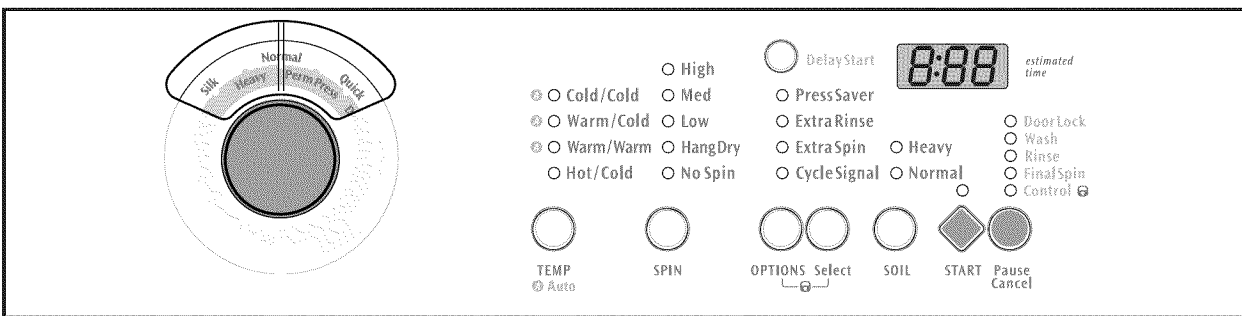

This manual covers many models and not all cycles, options, or features listed are available on every model. Console shown above for reference only. Your model may differ.

Cycle Selection

Turn the cycle selector in either direction to the cycle desired.

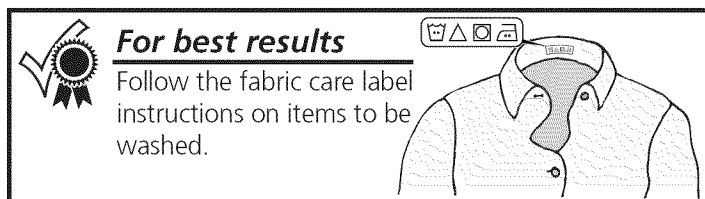

To change the cycle once it has begun, press the **Pause/Cancel** button twice before selecting a new cycle. Just turning the cycle selector knob to another selection will not change the cycle. If the selection is changed after the cycle starts, the indicator lights will blink, the signal will beep and "Err" will be displayed. The signal will beep and the status lights will flash, but the original cycle will continue.

Heavy

The **Heavy** cycle provides 16 minutes of reversing tumble wash action for heavily soiled sturdy items, followed by 2 rinses, an automatic **Extra Rinse** and a final spin. Hot water is recommended to remove heavy soil and most stains. **Extra Spin** is an available option.

Normal

The **Normal** cycle provides 13 minutes of reversing tumble wash action for normally soiled loads, followed by 2 rinses and a final spin. **Extra Rinse** and **Extra Spin** are available options.

Perm Press

Perm Press cycle provides 10 minutes of reversing tumble wash action for cottons and blends with a no-iron finish followed by a Cool Down rinse, 2 additional rinses and a final spin. To minimize wrinkling, the **Warm Rinse** and **Extra Spin** are not available with this cycle. The **Extra Rinse** and **Press Saver** options can be selected.

Quick

Quick cycle provides 5 minutes of reversing tumble wash action for lightly soiled items that must be laundered quickly, followed by 2 rinses and a final spin.

Delicate

This cycle provides 10 minutes of gentle reversing wash action for knits and delicates, followed by 2 rinses and a final spin. To protect your delicate items, a hot water wash is not available. The **Extra Rinse** and **Press Saver** options are available.

Handwash

Select the **Handwash** cycle for items labeled "Hand Washable". Ten minutes of occasional tumbling are followed by 2 rinses and a slow final spin. To protect your hand washables, a hot water wash and the **Extra Spin** option are not available. **Extra Rinse** and **Press Saver** are available options.

Touch Up

Use this cycle to refresh items that are not soiled, such as clean garments removed from luggage or storage containers, seasonal items from closets, or wet loads forgotten in the washer. Use half the detergent dose to prevent oversudsing. Three minutes of regular reversing tumble action are followed by 2 rinses and a final spin. The **Extra Spin** option is not available with this cycle. **Extra Rinse** and **Press Saver** are available options.

Drain/Spin

Use the **Drain/Spin** cycle as a follow-up to a **No Spin** selection or anytime you want to drain water from the washer and spin out the load. Select the spin speed appropriate to the load.

Rinse/Spin

Select **Rinse/Spin** for loads that need a cold water rinse or to add fabric softener that may have been omitted in a regular cycle. Add the fabric softener to the dispenser chamber. Select the spin speed appropriate for the load.

Soak

Use this cycle to soak heavily soiled and stained items before washing. Only cold water is available with this cycle because warmer water may set some stains. Add half the detergent dose and a detergent booster, if desired, to the detergent compartment. Six minutes of regular reverse tumble action are followed by 30 minutes of occasional tumbling as the load soaks. The water will drain out and the load will spin slowly for a short time. Follow **Soak** with a complete wash cycle suitable for the load and a full detergent dose.

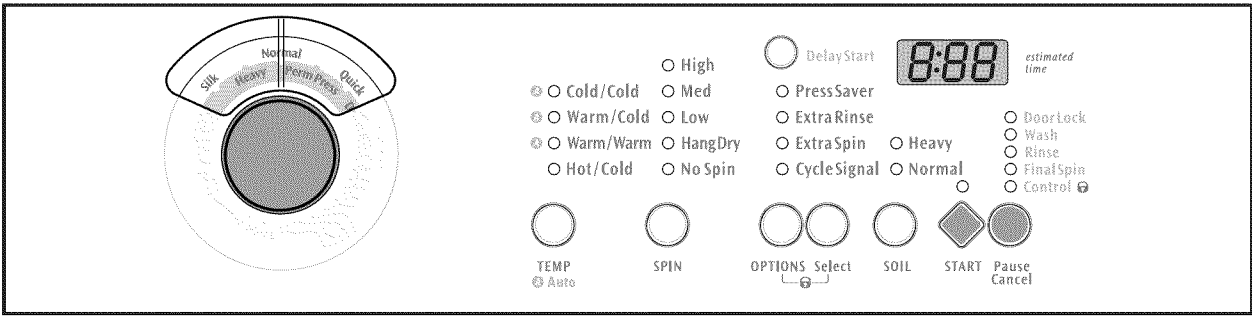

This manual covers many models and not all cycles, options, or features listed are available on every model. Console shown above for reference only. Your model may differ.

Cycle Selection, continued

Bulky

This cycle is designed for bulky items such as comforters, blankets, mattress pads, sleeping bags and similar items. Ten minutes of normal reversing tumble wash action are followed by 5 minutes of gentle tumbling, 2 rinses and a final spin. The **Extra Rinse** and **Extra Spin** options are available with this cycle.

Wool

Select the **Wool** cycle for **washable** wool items. Ten minutes of occasional tumbling are followed by 2 rinses and a slow final spin. If **Warm/Warm** is selected, both rinses are warm water. If **Cold/Cold** is selected, both rinses are cold water. **Warm/Cold**, **Hot/Cold**, **Extra Spin**, **Press Saver** and **Hang Dry** are not available options. Water will not enter the bleach chamber of the dispenser. If an additional rinse is desired, select **Extra Rinse**.

NOTE Washing wool garments labeled “**Dry Clean Only**” or using chlorine bleach can result in permanent damage.

Sport

This cycle is designed for small loads of lightweight, synthetic apparel worn for working out, running, swimming, cycling, tennis and similar activities when removal of light soil and perspiration are important. Items will occasionally tumble slowly as they soak for 5 minutes. Reverse tumble wash action will continue for 6 minutes followed by 2 rinses and a final spin. A hot water wash is not available with this cycle.

For best results, select a detergent that contains enzymes and the hottest wash water safe for the load. Add a detergent booster, color safe bleach or odor eliminator with the detergent if needed. Chlorine bleach should not be used on items containing Lycra™. Fabric softeners reduce wicking and are not recommended for garments made to pull moisture away from the body.

Silk

Select the **Silk** cycle for **washable** silk items. Six minutes of gentle reversing tumble wash action in cold water is followed by 2 rinses and an automatic **Extra Rinse**. Chlorine bleach will not be dispensed in this cycle. The water will drain out at the end of the cycle, but the drum will not spin. The garments will be very wet.

NOTE Washing silk garments labeled “**Dry Clean Only**” or using chlorine bleach can result in permanent damage.

Cycle Settings

Wash/Rinse Water Temperature

To change the temperature, press the **TEMP** button to scroll to the desired setting. Select a wash water temperature according to fiber content, colorfastness and soil level. A cold water rinse saves energy and reduces wrinkling.



For best results

Follow the fabric care label instructions on items to be washed.

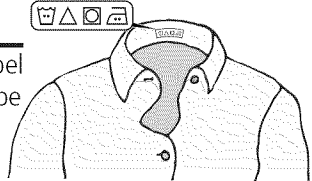

To protect your fabrics, not all temperatures are available with every cycle. The indicator will not light if the setting is not available with that cycle.

The temperature selected for the cycle will be remembered and recalled each time that cycle is selected in the future. To return to factory settings, press the **Pause/Cancel** and **Select** buttons at the same time and hold until the signal sounds.

NOTE To change the temperature once the cycle has begun, press the **Pause/Cancel** button **once**, make the new selection and press **Start** again.

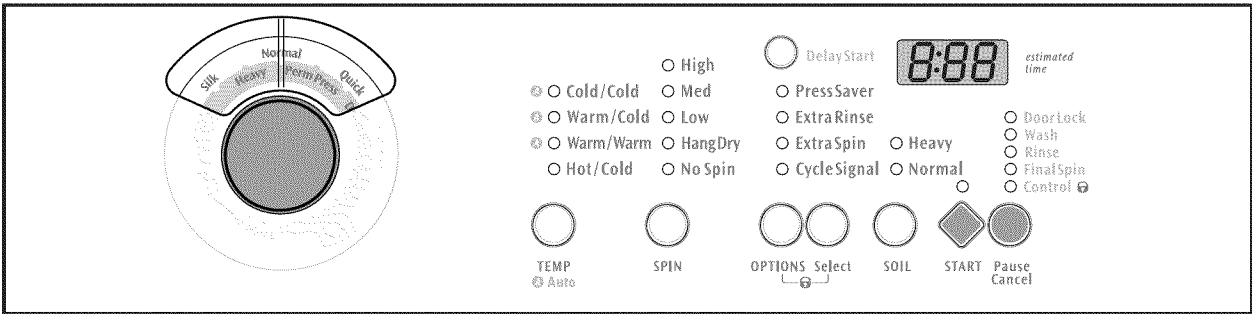

This manual covers many models and not all cycles, options, or features listed are available on every model. Console shown above for reference only. Your model may differ.

Cycle Settings, continued

Auto Temp wash water temperatures are automatically regulated to maximize detergent effectiveness and improve washing performance. The water heater setting and its distance from the washer, water usage in other parts of the home, and seasonally low ground water temperature in some geographic areas can affect water temperature.

Hot/Cold

Use this setting for heavily soiled, white/colorfast cotton and perm press loads.

Warm/Warm

Use this setting for washable woolens or when a warm water rinse is desired.

Warm/Cold

Use this setting for normally soiled, white/colorfast cotton and perm press loads.

Cold/Cold

Some warm water will automatically blend with cold tap supply to achieve a precise **Auto Temp Cold**. Use this setting for lightly soiled non-colorfast items, knits, delicates, and hand washables.

Spin Speed

High, **Med**, and **Low** spin speeds are available for each cycle. The spin speed and/or duration of final spin vary from cycle to cycle. For example, **High** speed in the **Normal** cycle is much faster than **High** speed in the **Handwash** cycle.

- Increasing the spin speed will extract more water, decrease drying time and conserve energy.
- Decreasing the spin speed will reduce wrinkling.
- HANG DRY** is available with some cycles to gently spin items that should not be machine dried.
- Use **No Spin** to omit the final spin at the end of the cycle. The load will be very wet. Remove items from the wash drum to drip dry or select the **Drain/Spin** cycle to remove excess water at a more convenient time.

Soil Level

Select **Heavy SOIL** to increase the wash time or **Normal SOIL** to decrease the wash time in some cycles.

Cycle Options

To select or delete the **Press Saver**, **Extra Rinse**, **Extra Spin** or **Cycle Signal**, press **OPTIONS** until the blinking light indicates the desired option. Then, while it is blinking, press **Select**. The indicator will light when the option has been selected. It will no longer be lighted when the option has been removed.

Not all options are available on every model or are compatible with every cycle. The indicator will not light if the option is not available with that cycle.

NOTE To change the options once the cycle has begun, press the **Pause/Cancel** button **once**, make the new selection and press **Start** again.

The options selected for the cycle will be remembered and recalled each time that cycle is selected in the future. To return to factory settings, press the **Pause/Cancel** and **Select** buttons at the same time and hold until the signal sounds.

Press Saver

Adding the **Press Saver** option alters the spin pattern of the cycle to further reduce wrinkling.

NOTE Use only with light or delicate items.

Extra Rinse

Use this option when additional rinsing is desired to remove excess dirt and detergent. It is recommended for heavily soiled loads or if household members have sensitive skin.

Extra Rinse occurs before the final rinse when the liquid fabric softener is dispensed.

Extra Spin

Use this option to add several additional minutes to the final spin at the selected speed. This will improve water extraction and decrease drying time.

Cycle Signal

A signal will sound at the end of the cycle if this option is selected.

Other Features

Delay Start

Press **Delay Start** to select a wash time convenient to your schedule or during off peak energy hours. The start of the cycle can be delayed for up to 12 hours. The delay time selected will be displayed as 30, 60 or 90 minutes or 2 through 12 hours.

Control Lock

To avoid having someone accidentally start or stop the washer, press **OPTIONS** and **Select** at the same time and hold for 10 seconds until "**LOC**" is displayed alternately with the estimated cycle time. To unlock the controls, press **OPTIONS** and **Select** at the same time and hold 10 seconds until "**LOC**" is no longer displayed.



Status Display/Status Lights

The estimated total cycle time will be displayed when the cycle is selected. The time may increase if water pressure is low, oversudsing occurs or the load becomes unbalanced. The estimated remaining cycle time is displayed during the cycle. The following indicators may be lighted during the cycle:

- Door Lock
- Wash
- Rinse
- Final spin
- Control 

Washer Settings Chart

These Temperature, Spin Speeds, Soil Levels and Options are available with the following cycles:

	Heavy	Normal	Perm Press	Quick	Delicate	Hand-wash	Silk	Wool	Sport	Bulky	Soak	Touch Up	Rinse Spin	Drain Spin
Estimated Cycle Duration**	49 min	44 min	31 min	32 min	30 min	28 min	28 min	28 min	33 min	42 min	42 min	30 min	19 min	13 min
Temperature														
 Cold/Cold	✓	✓	✓	✓	✓*	✓*	✓*	✓*	✓	✓	✓*	✓*	✓*	
 Warm/Cold	✓	✓*	✓*	✓*	✓	✓			✓*	✓*		✓	✓	
 Warm/Warm	✓	✓		✓	✓	✓		✓	✓	✓		✓	✓	
Hot/Cold	✓*	✓	✓	✓						✓				
Spin Speed														
High	✓*	✓*	✓*	✓*	✓*	✓*		✓*	✓*	✓*	✓*	✓*	✓*	✓*
Med	✓	✓	✓	✓	✓	✓		✓	✓	✓	✓	✓	✓	✓
Low	✓	✓	✓	✓	✓	✓		✓	✓	✓	✓	✓	✓	✓
Hang Dry			✓		✓	✓			✓			✓	✓	✓
No Spin	✓	✓	✓	✓	✓	✓	✓*	✓	✓	✓	✓	✓	✓	✓
Soil Level														
Heavy	✓	✓	✓											
Normal	✓*	✓*	✓*	✓*	✓*	✓*	✓*	✓*	✓*	✓*		✓*		
Options														
Delay Start	✓	✓	✓	✓	✓	✓	✓	✓	✓	✓	✓	✓	✓	✓
Extra Rinse	✓	✓	✓		✓	✓	✓*	✓	✓	✓		✓		
Extra Spin	✓	✓							✓	✓				
Press Saver			✓		✓	✓						✓	✓	
Cycle Signal	✓*	✓*	✓*	✓*	✓*	✓*	✓*	✓*	✓*	✓*	✓*	✓*	✓*	✓*

* Factory presets ✓ Available selections

**Estimated cycle duration is based on factory settings and does not include water fill times, out-of-balance, or oversudsing conditions.

Safe Stain Removal Procedures

To reduce the risk of fire or serious injury to persons or property, comply with the basic warnings listed below:

- Read and comply with all instructions on stain removal products.
- Keep stain removal products in their original labeled containers and out of children's reach.
- Thoroughly wash any utensils used.
- Do not combine stain removal products, especially ammonia and chlorine bleach. Dangerous fumes can result.
- Never wash items which have been previously cleaned in, washed in, soaked in or spotted with gasoline, dry cleaning solvents or other flammable or explosive substances because they give off vapors that could ignite or explode.
- Never use highly flammable solvents, such as gasoline, inside the home. Vapors can explode on contact with flames or sparks.

For Successful Stain Removal:

- Remove stains promptly.
- Determine the kind of stain, then follow the recommended treatment in the stain removal chart on the next page.
- To pretreat stains, use a prewash product, liquid detergent, or a paste made from powder detergent and water.
- Use cold water on unknown stains because hot water can set stains.
- Consult care label instructions for treatments to avoid on specific fabrics.
- Check for colorfastness by testing stain remover products on an inside seam.
- Rinse and wash items after stain removal.

⚠ WARNING - HARMFUL VAPOR HAZARD - Do not use or mix liquid chlorine bleach with other household chemicals such as toilet cleaners, rust removers, acid or products containing ammonia. These mixtures can produce dangerous fumes which can cause serious injury or death.



Stain Removal Suggestions

STAIN	TREATMENT
Adhesive tape, chewing gum, rubber cement	Apply ice. Scrape off excess. Place stain face down on paper towels. Saturate with prewash stain remover or nonflammable dry cleaning fluid.
Baby formula, dairy products, egg	Use product containing enzymes to pretreat or soak stains. Soak for 30 minutes or more. Wash.
Beverages (coffee, tea, soda, juice, alcoholic beverages)	Pretreat stain. Wash using cold water and bleach safe for fabric.
Blood	Rinse with cold water. Rub with bar soap. Or, pretreat or soak with product containing enzymes. Wash using bleach safe for fabric.
Candle wax, crayon	Scrape off surface wax. Place stain face down between paper towels. Press with warm iron until wax is absorbed. Replace paper towels frequently. Treat remaining stain with prewash stain remover or nonflammable dry cleaning fluid. Hand wash to remove solvent. Wash using bleach safe for fabric.
Chocolate	Pretreat or soak in warm water using product containing enzymes. Wash using bleach safe for fabric.
Collar or cuff soil, cosmetics	Pretreat with prewash stain remover or rub with bar soap.
Dye transfer on white fabric	Use packaged color remover. Wash using bleach safe for fabric.
Grass	Pretreat or soak in warm water using product containing enzymes. Wash using bleach safe for fabric.
Grease, oil, tar (butter, fats, salad dressing, cooking oils, car grease, motor oils)	Scrape residue from fabric. Pretreat. Wash using hottest water safe for fabric. For heavy stains and tar, apply nonflammable dry cleaning fluid to back of stain. Replace towels under stain frequently. Rinse thoroughly. Wash using hottest water safe for fabric.
Ink	Some inks may be impossible to remove. Washing may set some inks. Use prewash stain remover, denatured alcohol or nonflammable dry cleaning fluid.
Mildew, scorch	Wash with chlorine bleach if safe for fabric. Or, soak in oxygen bleach and hot water before washing. Badly mildewed fabrics may be permanently damaged.
Mud	Brush off dry mud. Pretreat or soak with product containing enzymes.
Mustard, tomato	Pretreat with prewash stain remover. Wash using bleach safe for fabric.
Nail polish	May be impossible to remove. Place stain face down on paper towels. Apply nail polish remover to back of stain. Repeat, replacing paper towels frequently. Do not use on acetate fabrics.
Paint, varnish	WATER BASED: Rinse fabric in cool water while stain is wet. Wash. Once paint is dry, it cannot be removed. OIL BASED AND VARNISH: Use solvent recommended on can label. Rinse thoroughly before washing.
Perspiration	Use prewash stain remover or rub with bar soap. Rinse. Wash using nonchlorine bleach in hottest water safe for fabric.
Rust, brown or yellow discoloration	Use rust remover safe for fabric. Do not use chlorine bleach because it may intensify discoloration.
Shoe polish	LIQUID: Pretreat with a paste of powder detergent and water. PASTE: Scrape residue from fabric. Pretreat with prewash stain remover or nonflammable dry cleaning fluid. Rinse. Rub detergent into dampened area. Wash using bleach safe for fabric.
Tomato	Pretreat with prewash stain remover. Wash using bleach safe for fabric.
Urine, vomit, mucus, feces	Pretreat or soak in product containing enzymes. Wash using bleach safe for fabric.
Wine	Pretreat or soak in cold water. Wash in hottest water and bleach safe for fabric

Inside Routine Cleaning (Preventative)

To help prevent odors, mold or mildew, leave the door open for a few hours after use or whenever the washer is not in use.

⚠ CAUTION - *ENTRAPMENT and TIP-OVER HAZARD* - Do not leave the door open if there are small children or pets present. An open door could entice children to hang on the door or crawl inside the washer. If there are no small children present, you may leave the door ajar to prevent odor build up.

To Refresh or Clean Inside of Washer

To clean and freshen the washer, perform the **Clean Washer** cycle. For best results use the **Clean Washer** cycle once a month. To begin the cycle, select the heaviest wash cycle, hot wash temperature, highest spin speed, and extra rinse.

IMPORTANT Items left in washer while performing the **Clean Washer** cycle will cause a severe out-of-balance situation that could damage the washing machine.

REMOVE ALL ITEMS FROM WASH DRUM before filling the detergent chamber with one (1) cup of liquid chlorine bleach OR one (1) pouch of TIDE® WASHING MACHINE CLEANER. DO NOT use both. Press **Start** to begin.



For best results

Immediately follow up with a **Rinse/Spin** cycle and select **High** spin speed with no detergent or bleach to help clear any residual bleach left after the **Clean Washer** Cycle.

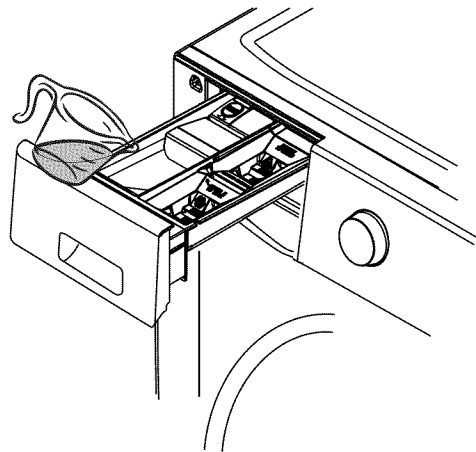

⚠ WARNING - *HARMFUL VAPOR HAZARD* - Do not use or mix liquid chlorine bleach with other household chemicals such as toilet cleaners, rust removers, acid or products containing ammonia. These mixtures can produce dangerous fumes which can cause serious injury or death.



Other Inside Routine Cleaning (Preventative)

Cleaning Dispenser Drawer Area

NOTE Detergent and fabric softener may build up in the dispenser drawer. Residue should be removed once or twice a month.

- Remove the drawer by pulling the drawer out until it stops.
- Reach back into the left rear corner of the drawer cavity and press down firmly on the lock tab. Pull out the drawer.
- Remove the insert from the bleach and fabric softener compartments.
- Rinse the drawer and inserts with a combination of $\frac{3}{4}$ cup liquid chlorine bleach and 1 gallon hot tap water to remove traces of accumulated powders and liquids. Large amounts of fabric softener residue may indicate improper dilution or more frequent cleaning is required. Rinse well with tap water.
- To clean the drawer opening, use a small brush to clean the recess. Remove all residue from the upper and lower parts of the recess.
- Replace the insert by pressing it in place until you hear a slight click. Return the dispenser drawer.

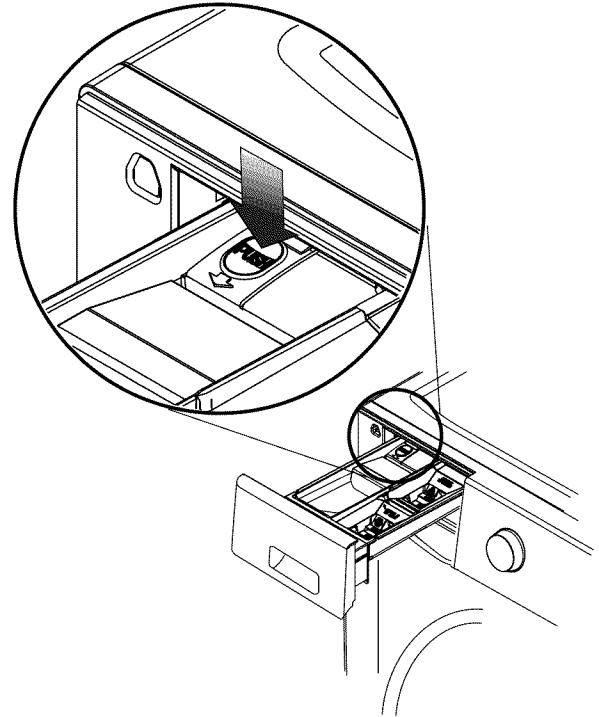

Daily Preventative Maintenance

- Remove items from the washer as soon as the cycle ends. Excess wrinkling, color transfer, and odors may develop in items left in the washer.
- If there are no small children or pets present, you may leave the door ajar when the washer is not in use.
- Leave the dispenser drawer open slightly at the end of the wash day.

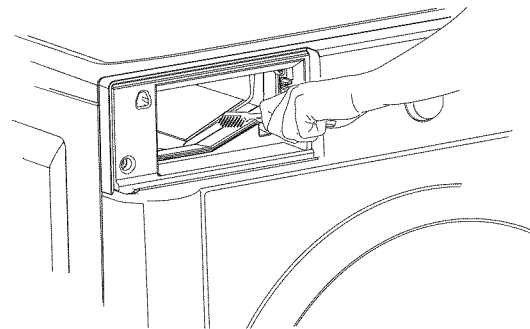
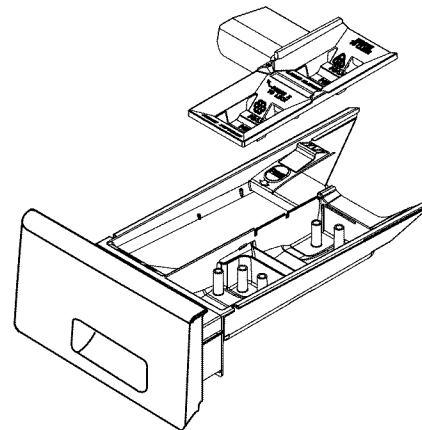

Outside Routine Cleaning

- When washing is completed, wipe top and sides of washer with a damp cloth. Turn water faucets off to prevent pressure build-up in the hoses.
- Clean the cabinet with mild soap and water. Never use harsh, gritty or abrasive cleansers
- If the cabinet becomes stained, clean with diluted chlorine bleach (1 part bleach to 8 parts water). Rinse several times with clear water.
- Remove glue residue from tape or labels with a mixture of warm water and mild detergent. Or, touch residue with the sticky side of tape.
- When cleaning chrome parts use a window cleaner with ammonia or mild soap and water.
- Before moving the washer, place a strip of cardboard or thin fiberboard under the front leveling legs to prevent damage to the floor.

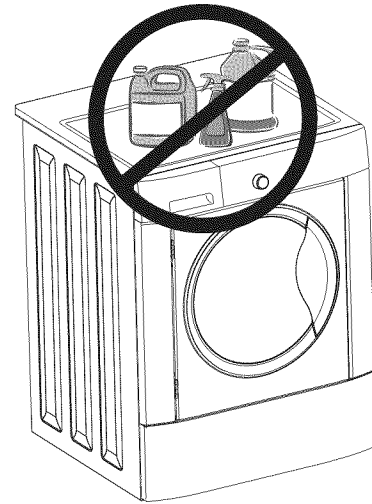

IMPORTANT Do not store or place laundry products on top of washer at any time. They can damage the finish or controls.

Winterizing Instructions

IMPORTANT If the washer is stored in an area where freezing can occur or moved in freezing temperatures, follow these winterizing instructions to prevent damage to the washer:

1. Turn off water supply faucets.
2. Disconnect hoses from water supply and drain water from hoses.
3. Plug electrical cord into a properly grounded electrical outlet.
4. Add 1 gallon (3.8 L) nontoxic recreational vehicle (RV) antifreeze to empty wash drum. Close door.
5. Select the Spin Only cycle. Press Start and let the washer drain for 1 minute to drain out all the water. Not all of the RV antifreeze will be expelled.
6. Press Cancel, unplug electrical power cord, dry off drum interior and close door.
7. Remove dispenser drawer. Drain any water in compartments and dry compartments. Replace drawer.
8. Store washer in an upright position.
9. To remove antifreeze from washer after storage, perform Clean System Cycle as described earlier.

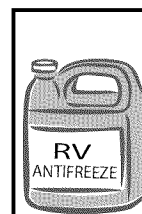

Follow **WINTERIZING INSTRUCTIONS** for cold weather storage and care.

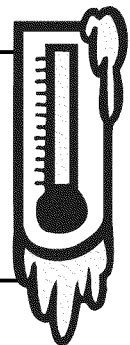

Common Washing Problems

Many washing problems involve poor soil and stain removal, residues of lint and scum, and fabric damage. For satisfactory washing results, follow these suggestions provided by The Soap and Detergent Association.

PROBLEM	POSSIBLE CAUSES	SOLUTIONS	PREVENTIVE MEASURES
Blue stains	<ul style="list-style-type: none"> • Undiluted liquid detergent or fabric softener dispensed directly onto fabric. 	<ul style="list-style-type: none"> • If caused by detergent, mix 1 cup (240 ml) white vinegar with 1 quart (.95 L) water in a plastic container. Soak item 1 hour. Rinse. • If caused by fabric softener, rub stains with bar soap. Wash. 	<ul style="list-style-type: none"> • Avoid overfilling detergent and fabric softener compartments of dispenser.
Discoloration, graying	<ul style="list-style-type: none"> • Not enough detergent. • Wash water temperature too low. • Incorrect sorting. 	<ul style="list-style-type: none"> • Rewash with correct amount of detergent and hottest water safe for fabric. • Add bleach safe for fabric. 	<ul style="list-style-type: none"> • Sort items by soil level and color. • Use correct amount of detergent, hottest water and bleach safe for fabric.
Greasy, oily stains	<ul style="list-style-type: none"> • Not enough detergent. • Undiluted liquid fabric softener poured directly on fabric. 	<ul style="list-style-type: none"> • Treat with prewash stain remover or liquid detergent. • Increase detergent and water temperature. Rewash. • Rub fabric softener stains with bar soap. 	<ul style="list-style-type: none"> • Use correct amount of detergent and hottest water safe for fabric. • Do not pour liquid fabric softener directly on fabric. See Operating Your, step 5.
Holes, tears, or snags	<ul style="list-style-type: none"> • Incorrect use of chlorine bleach. • Unfastened zippers, hooks, buckles. • Rips, tears and broken threads. • Overloading the washer. • Degradation of fabric. 	<ul style="list-style-type: none"> • May be irreversible if rips, tears and seams cannot be mended. 	<ul style="list-style-type: none"> • Never pour chlorine bleach directly on fabric. • Check condition of items before washing. See Operating Your, steps 2 and 5.
Lint	<ul style="list-style-type: none"> • Incorrect sorting. • Tissues left in pocket. • Overloading the washer. • Not enough detergent. • Undissolved detergent has left a residue resembling lint. • Static cling is attracting lint. • Load washed too long. 	<ul style="list-style-type: none"> • Reduce load size. Rewash using correct water temperature, water level, and amount of detergent. • Add nonprecipitating water conditioner to wash water to remove detergent residue. • Add liquid fabric softener to final rinse. • Dry load in dryer. • Remove lint with lint brush or roller. 	<ul style="list-style-type: none"> • See Operating Your, steps 1 and 2. • Do not overload washer. • Use correct temperature and amount of detergent, water and wash time.
Pilling (Fibers ball up and cling to fabric.)	<ul style="list-style-type: none"> • Pilling is normal with synthetic and permanent press fabrics. This is due to abrasion from normal wear. 	<ul style="list-style-type: none"> • Use a lint brush or shaver to remove pills. 	<ul style="list-style-type: none"> • Use fabric softener in the washer to lubricate fibers. • When ironing, use spray starch or fabric finish on collars and cuffs. • Turn items inside out to reduce abrasion.
Residue or powder on dark items; Stiff, harsh fabrics.	<ul style="list-style-type: none"> • Undissolved detergent. • Some granular detergents can combine with hard water minerals to form a residue. • Overloading the washer. 	<ul style="list-style-type: none"> • Rewash load. 	<ul style="list-style-type: none"> • Increase water temperature using hottest water safe for fabric. • Do not overload washer. • Use liquid detergent or use nonprecipitating water conditioner with powder detergent.
Wrinkling	<ul style="list-style-type: none"> • Overloading the washer. • Incorrect wash cycle for wash load. 	<ul style="list-style-type: none"> • Reduce load size. • Rinse in cold water with liquid fabric softener using the casual or delicate cycle. 	<ul style="list-style-type: none"> • Do not overload washer. • Remove items from washer as soon as cycle is completed. • Use liquid fabric softener.

Common Washing Problems, continued

PROBLEM	POSSIBLE CAUSES	SOLUTIONS	PREVENTIVE MEASURES
Yellow buildup of body soil on synthetic fabrics	<ul style="list-style-type: none"> • Agitation time too short. • Wash water temperature too low. • Not enough detergent. 	<ul style="list-style-type: none"> • Soak in detergent booster or product containing enzymes. • Wash in hottest water safe for fabric using casual cycle. • Increase detergent. • Add bleach safe for fabric or treat with color remover. 	<ul style="list-style-type: none"> • Select correct wash cycle. • Use correct amount of detergent. • Wash synthetics frequently using hot or warm water.
Yellow or brown rust stains	<ul style="list-style-type: none"> • Iron or manganese in water supply, water pipes, or water heater. 	<ul style="list-style-type: none"> • To restore discolored load of whites, use rust remover safe for fabric. • Do not use chlorine bleach to remove rust stains. It may intensify discoloration. 	<ul style="list-style-type: none"> • Use nonprecipitating water softener. • Before washing, run hot water for a few minutes to clear lines. • Drain water heater occasionally. • For an ongoing problem, install an iron filter in your water supply system.
Residue stains / buildup, mold or mildew stains in gasket	<ul style="list-style-type: none"> • Moisture in the washer. • Use of non-HE detergent. • Overdosing detergent. • Overloading wash drum. • Leaving a wet load set in washer. • Cold water washes which may not completely dissolve and remove detergents. 	<ul style="list-style-type: none"> • Perform SYSTEM CLEAN cycle • Scrub gasket with Comet™ Spray Gel Mildew Stain Remover using brush to remove stains. • Use only HE (high efficiency detergent) along with recommended dosage. • Remove wash load immediately upon cycle completion. 	<ul style="list-style-type: none"> • Run dehumidifier in laundry room. • Avoid overfilling detergent and fabric softener compartments of dispenser. • Dry the inside of washer and gasket after every run.
Residue stains / buildup, mold or mildew stains in dispenser drawer	<ul style="list-style-type: none"> • Moisture in the washer. • Use of non-HE detergent. • Overdosing detergent. 	<ul style="list-style-type: none"> • Remove dispenser drawer and wipe dispenser and inserts with combination of $\frac{3}{4}$ cup liquid chlorine bleach and one gallon hot water. Rinse well, and repeat if necessary. Return drawer to location. NOTE: Wear rubber or latex gloves. Protect floor and clothing from bleach damage. • Use only HE (high efficiency detergent) along with recommended dosage. 	<ul style="list-style-type: none"> • Avoid overfilling detergent and fabric softener compartments of dispenser.
Water in fold of flexible gasket	<ul style="list-style-type: none"> • Result of washing and part of normal operation. 	<ul style="list-style-type: none"> • At the end of each wash, dry inside of gasket fold with clean dry towel all around gasket. 	
Odor	<ul style="list-style-type: none"> • Moisture in the washer. • Use of non-HE detergent. • Overdosing detergent. • Leaving a wet load remain in washer. • Cold water washes which may not completely dissolve and remove detergents. 	<ul style="list-style-type: none"> • Perform SYSTEM CLEAN cycle. • At the end of each wash, dry inside of gasket fold with clean, dry towel all around gasket. • Use only HE (high efficiency detergent) along with recommended dosage. • Remove wash load immediately upon cycle completion. • Pour one cup liquid chlorine bleach in standpipe; let remain a day and flush with water. 	<ul style="list-style-type: none"> • Leave door and dispenser drawer open for a few hours after use or whenever washer is not in use.

Service Prevention Checklist

Before calling for service, review this list. It may save both time and expense. The list includes common occurrences that are not the result of defective workmanship or materials in this washer.

OCCURRENCE	POSSIBLE CAUSE	SOLUTION
NOISE		
High pitch "jet engine" noise.	A certain amount of motor whine is normal during the spin cycle.	
Rattling and clanking noise.	Foreign objects such as coins or safety pins may be in drum or pump.	Stop washer and check drum. If noise continues after washer is restarted, objects may be in pump. Call your authorized servicer.
	Belt buckles and metal fasteners are hitting wash drum.	To prevent unnecessary noise and damage to drum, fasten fasteners and turn items inside out.
Thumping sound.	Heavy wash loads may produce a thumping sound. This is usually normal. If sound continues, washer is probably out of balance.	Stop washer and redistribute wash load.
Vibrating noise.	Washer is not resting firmly on floor.	Move washer so it rests firmly on floor. Adjust leveling legs. See INSTALLATION INSTRUCTIONS for details.
	Shipping bolts and foam block have not been removed during installation.	See INSTALLATION INSTRUCTIONS for removing shipping bolts and foam block.
	Wash load unevenly distributed in drum.	Stop washer and rearrange wash load.
OPERATING		
Washer does not start.	Electrical power cord may not be plugged in or connection may be loose.	Make sure plug fits tightly in wall outlet.
	House fuse blown, circuit breaker tripped, or a power outage has occurred.	Reset circuit breaker or replace fuse. Do not increase fuse capacity. If problem is a circuit overload, have it corrected by a qualified electrician. If problem is a power outage, call local electric company.
	Water supply faucets are not turned on.	Turn on water supply faucets.
	Motor is overheated. Washer motor will stop if it becomes overheated.	It will automatically restart after a cool down period of up to 30 minutes (if washer has not been manually turned off).
	Washer door is not completely closed.	Close door completely.
Washer won't spin.	Load is too small.	Add 1 or 2 similar items to help balance the load.
Residue left in drum.	Heavily soiled items.	Wipe drum with a nonabrasive household cleanser, then rinse. Shake or brush excess dirt and sand from items before washing

Service Prevention Checklist, continued

OCCURRENCE	POSSIBLE CAUSE	SOLUTION
WATER		
Water collects in folds of the bellows at the end of the cycle.	This is a result of the washing action and is part of the normal operation of the washer.	
Water collects in bleach and fabric softener compartments.	This is a result of the siphoning action and is part of the normal operation of the washer.	Water may be removed by removing the dispenser drawer (see Care and Cleaning in this guide) and draining water into the empty drum or sink.
Wash load too wet after spin.	Washer is overloaded.	Do not overload washer. See Operating Your Washer, step 4.
	Load is too small.	Add 1 or 2 similar items to help balance the load.
	Load is out of balance.	Rearrange load to allow proper spinning.
	Drain hose is kinked.	Straighten drain hose.
Water does not enter washer or it enters slowly.	Water supply is not adequate in area.	Check another faucet in the house. Wait until water supply and pressure increase.
	Water supply faucets are not completely open.	Fully open hot and cold faucets.
	Water is being used elsewhere in the house. Water pressure must be at least 30 psi (260 kPa).	Avoid running water elsewhere while washer is filling.
	Water inlet hoses are kinked.	Straighten hoses.
Warm or hot water is not hot enough.	Hot water heater is set too low or is a distance from washer.	Measure hot water temperature at nearby faucet with candy or meat thermometer. Water temperature should be at least 120°F (49°C). Adjust water heater as necessary.
	Hot water is being used elsewhere in the house.	Avoid using hot water elsewhere before or during washer use. There may not be enough hot water available for proper cleaning. If problem persists, your hot water system may be unable to support more than 1 use at a time.
Water in washer does not drain or drains slowly.	Drain hose is kinked or clogged.	Clean and straighten the drain hose.
	Drain hose standpipe is too tall. Maximum standpipe height is 8' (2.4 m).	Reduce standpipe height to less than 8' (2.4 m). See INSTALLATION INSTRUCTIONS.
	House drain pipes are clogged.	Unclog drain pipes. Contact plumber if necessary.
Water leaks.	Fill hose connection is loose at faucet or washer.	Check and tighten hose connections. Install rubber sealing washers provided.
Oversudsing.	Wrong detergent.	Run rinse cycle. Use a low-sudsing, high efficiency detergent.
	Too much detergent.	Run rinse cycle. Use less detergent in future loads.
Incorrect wash and rinse temperatures.	Hot and cold water hoses are connected to wrong supply faucets.	Connect hot water hose to hot water faucet and cold water hose to cold water faucet.
Water is entering washer but tub does not fill.	Drain hose standpipe is too low. Standpipe must be a minimum of 23.6" (60 cm) high to prevent siphoning.	Increase standpipe height to at least 23.6" (60 cm). See INSTALLATION INSTRUCTIONS.

CROSLEY APPLIANCE WARRANTY

Your appliance is covered by a one year limited warranty. For one year from your original date of purchase, Crosley Corporation will pay all costs for repairing or replacing any parts of this appliance that prove to be defective in materials or workmanship when such appliance is installed, used and maintained in accordance with the provided instructions.

Exclusions

This warranty does not cover the following:

1. Products with original serial numbers that have been removed, altered or cannot be readily determined.
2. Product that has been transferred from its original owner to another party or removed outside the USA or Canada.
3. Rust on the interior or exterior of the unit.
4. Products purchased "as-is" are not covered by this warranty.
5. Food loss due to any refrigerator or freezer failures.
6. Products used in a commercial setting.
7. Service calls which do not involve malfunction or defects in materials or workmanship, or for appliances not in ordinary household use or used other than in accordance with the provided instructions.
8. Service calls to correct the installation of your appliance or to instruct you how to use your appliance.
9. Expenses for making the appliance accessible for servicing, such as removal of trim, cupboards, shelves, etc., which are not a part of the appliance when it is shipped from the factory.
10. Service calls to repair or replace appliance light bulbs, air filters, water filters, other consumables, or knobs, handles, or other cosmetic parts.
11. Surcharges including, but not limited to, any after hour, weekend, or holiday service calls, tolls, ferry trip charges, or mileage expense for service calls to remote areas, including the state of Alaska.
12. Damages to the finish of appliance or home incurred during installation, including but not limited to floors, cabinets, walls, etc.
13. Damages caused by: services performed by unauthorized service companies; use of parts other than genuine Crosley parts or parts obtained from persons other than authorized service companies; or external causes such as abuse, misuse, inadequate power supply, accidents, fires, or acts of God.

DISCLAIMER OF IMPLIED WARRANTIES; LIMITATION OF REMEDIES

CUSTOMER'S SOLE AND EXCLUSIVE REMEDY UNDER THIS LIMITED WARRANTY SHALL BE PRODUCT REPAIR OR REPLACEMENT AS PROVIDED HEREIN. CLAIMS BASED ON IMPLIED WARRANTIES, INCLUDING WARRANTIES OF MERCHANTABILITY OR FITNESS FOR A PARTICULAR PURPOSE, ARE LIMITED TO ONE YEAR OR THE SHORTEST PERIOD ALLOWED BY LAW, BUT NOT LESS THAN ONE YEAR. CROSLEY CORPORATION SHALL NOT BE LIABLE FOR CONSEQUENTIAL OR INCIDENTAL DAMAGES SUCH AS PROPERTY DAMAGE AND INCIDENTAL EXPENSES RESULTING FROM ANY BREACH OF THIS WRITTEN LIMITED WARRANTY OR ANY IMPLIED WARRANTY. SOME STATES AND PROVINCES DO NOT ALLOW THE EXCLUSION OR LIMITATION OF INCIDENTAL OR CONSEQUENTIAL DAMAGES, OR LIMITATIONS ON THE DURATION OF IMPLIED WARRANTIES, SO THESE LIMITATIONS OR EXCLUSIONS MAY NOT APPLY TO YOU. THIS WRITTEN WARRANTY GIVES YOU SPECIFIC LEGAL RIGHTS. YOU MAY ALSO HAVE OTHER RIGHTS THAT VARY FROM STATE TO STATE.

If You Need Service

Keep your receipt, delivery slip, or some other appropriate payment record to establish the warranty period should service be required. If service is performed, it is in your best interest to obtain and keep all receipts. Service under this warranty must be obtained by contacting Crosley Corporation at the addresses or phone numbers below.

This warranty only applies in the USA and Canada. In the USA, your appliance is warranted by Crosley Corporation. In Canada, your appliance is warranted by Crosley Canada Corp. Crosley Corporation authorizes no person to change or add to any obligations under this warranty. Obligations for service and parts under this warranty must be performed by Crosley Corporation, Crosley Canada Corp, or an authorized service company. Product features or specifications as described or illustrated are subject to change without notice.

FOR WARRANTY INFORMATION CONTACT:

USA 800-944-9044
Canada 800-265-8352

FOR PRODUCT INFORMATION CONTACT:

336-761-1212
Crosley Corporation
111 Cloverleaf Dr.
Winston-Salem, NC 27103

www.crosley.com