



Owner's Manual



Top Loading Washer

Keep instructions for future reference. Be sure manual stays with washer.

Contents

Important Safety Information	3
Introduction	4
Starting the Wash	5
Cycles and Features	7
Dispensers	8
Features, Hints, and Care	9
Moving and Storage	10
Trouble Shooting	11
Warranty	13



Thank you for buying an Amana washer!

Please take the time to complete the registration card and return promptly. If registration card is missing, call Amana Consumer Affairs Department. When contacting Amana, provide product information from serial plate found on lower right hand corner of inner lid:

Model Number _____
Manufacturing (P) Number _____
Serial Number (S/N) _____
Purchase Date _____
Dealer Name _____
Dealer Address _____
Dealer Phone _____

Keep this manual and your sales receipt together in a safe place for future reference or if warranty service is required.

For answers to questions or to locate an authorized servicer, call 1(800) NAT-LSVC (1-800-628-5782) inside USA or (319)622-5511 outside USA. Warranty service must be performed by an authorized servicer. Amana Appliances also recommends contacting an authorized servicer if service is required after warranty expires.

Asure™ Extended Service Plan

Amana Appliances offers long-term service protection for this new washer. Asure™ Extended Service Plan, covering functional parts, labor, and travel charges, is specially designed to supplement a strong warranty. Call 1(800)528-2682 for information.

Parts and Accessories

Purchase replacement parts and additional accessories by phone. To order accessories for your Amana product, call 1(800)843-0304 inside USA or 1(319)622-5511 outside USA.

Save Time and Money

If something seems unusual, please check "Trouble Shooting" section, which is designed to help you solve problems before calling service. If you have a question, write or call us (include model number and phone number) at:

Consumer Affairs Department Amana
Appliances
2800 - 220th Trail
Amana, Iowa 52204
Ph# 1(800)843-0304

For more information on this and other Amana products, visit our Web site
www.amana.com
or
call Consumer Affairs Department at
1(800)843-0304

What You Need to Know about Safety Instructions

Warning and Important Safety Instructions appearing in this manual are not meant to cover all possible conditions and situations that may occur. Common sense, caution, and care must be exercised when installing, maintaining, or operating washer. Always contact your dealer, distributor, service agent, or manufacturer about problems or conditions you do not understand.

Recognize Safety Symbols, Words, Labels



DANGER—Immediate hazards which **WILL** result in severe personal injury or death.



WARNING—Hazards or unsafe practices which **COULD** result in severe personal injury or death.



CAUTION—Hazards or unsafe practices which **COULD** result in minor personal injury or product or property damage.

Important Safety Information



WARNING

To reduce risk of fire, electric shock, serious injury, or death when using your washer, follow these basic precautions:

1. Read all instructions before using washer.
2. Be sure washer is properly grounded.
3. Do not wash articles that have been cleaned in, washed in, soaked in, or spotted with gasoline, dry-cleaning solvents, or other flammable or explosive substances. Vapors could ignite or explode.
4. Do not add gasoline, dry-cleaning solvents, or other flammable or explosive substances to wash water. Vapors could ignite or explode.
5. Do not store or use gasoline or other flammable vapors and liquids near this or any other appliance.
6. Under certain conditions, hydrogen gas may be produced in a hot-water system that has not been used for 2 weeks or more. **HYDROGEN GAS IS EXPLOSIVE.** If hot-water system has not been used for such period, turn on all hot-water faucets and let water flow for several minutes before using washing machine. Do not smoke or use an open flame at this time.
7. Do not allow children to play on or in washer. Close supervision of children is necessary when washer is used near children, a safety rule for all appliances.
8. Before washer is removed from service or discarded, remove door to washing compartment.
9. Do not reach into washer if wash tub is moving or agitator is moving.
10. Do not install or store washer where it will be exposed to water and/or weather.
11. Do not tamper with washer controls.
12. Do not repair or replace any part of washer or attempt any service, unless specifically recommended in user-maintenance instructions or in published user-repair instructions that you understand and have skills to carry out.
13. To reduce risk of electric shock or fire, do not use extension cords or adapters to connect washer to electrical power source.
14. Use your washer only for its intended purpose: non-commercial clothes washing.
15. Always disconnect washer from electrical supply before attempting any service. Disconnect power cord by grasping the plug, not the cord.
16. Install washer according to Installation Instructions. All connections for water, drain, electrical power, and grounding must comply with local codes and be made by licensed personnel when required.
17. To reduce risk of fire, do not use washer to launder clothes which have traces of any flammable substance, such as vegetable oil, cooking oil, machine oil, flammable chemicals, thinner, etc., or anything containing wax or chemicals, such as mops and cleaning cloths. Flammable substances may cause fabric to catch fire by itself.
18. Use only fabric softeners or products to eliminate static that are appropriate for automatic washers.
19. Keep your washer in good condition. Bumping or dropping washer can damage safety features. If damage occurs, have washer checked by qualified service technician.
20. Replace worn power cords and/or loose plugs.
21. Loading door must be closed whenever washer is agitating or spinning. Do not bypass loading door switch by permitting washer to operate with loading door open.
22. Always read and follow manufacturer's instructions on packages of laundry and cleaning aids. Heed all warnings or precautions. To reduce risk of poisoning or chemical burns, keep products away from children at all times, preferably, in a locked cabinet.
23. Never operate washer with guards and/or panels removed.
24. Do not operate washer with missing or broken parts.
25. Do not bypass safety devices.



CAUTION

To reduce risk of property damage due to flooding of washer unit, please read the following information:

1. Do not pause an active cycle for longer than thirty minutes. Pressure switch may reset and cause tub to overflow.
2. Always turn Load Level knob to RESET before changing a water level.
3. **DO NOT** hold Load Level knob at RESET. Water will continue to fill as long as knob is held at RESET.

Save These Instructions

Introduction

Wash/Rinse Options Control

This works in conjunction with your Cycle Dial to regulate the spin and agitation of your cycle.

- The Heavy Soiled setting provides more agitation for thorough cleaning.
- The Normal setting provides a decreased level of agitation to improve fabric care and wrinkling.
- The Extra Rinse setting provides an automatic second rinse to better remove dirt and soap residue.

Cycle Dial

Choose the cycle according to the color, fabric type and soil level. The heavy and normal settings will provide more agitation than the light setting.

Water Temperature Control

Provides a choice of wash and rinse temperature settings. Sensor wash settings deliver consistent pre-set temperatures for warm(100°F/56°C) and cold(75°F/42°C) wash water.

Load Size Control

This allows you to select the water level in your wash tub to match load size

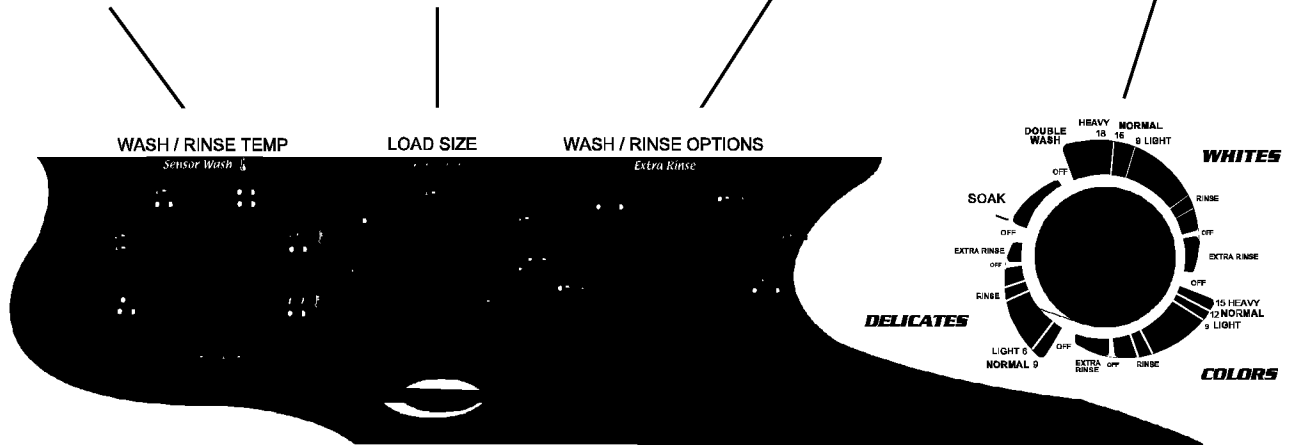

What do the colored dots on my control panel mean?

The control is color coded between the main timer cycles and the options to help the washer deliver the best cleaning performance. The color coded recommendations for temperature, and wash/rinse options provide a general guideline. Always refer to manufacturer's care label for specific settings.

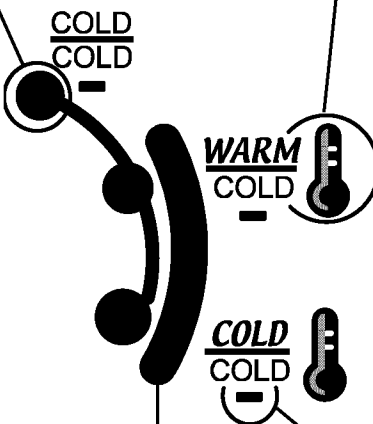

What does the thermometer symbol mean on my Water Temperature Control?

The washer features an automatic temperature control sensor for the washer water. This sensor regulates the wash water temperature to approximately 75°F(42°C) for cold, and approximately 100°F(56°C) for warm. Sensor wash settings will help insure detergents work effectively to deliver optimum cleaning performance.

What does the dash mean on my Water Temperature Control?

The dash indicates an energy saving selection. The marked temperature settings use the least amount of energy.

What does the arc mean on my control panel?

The arc shows where on the dial the feature is active. The arc is used to show the active settings of the sensor wash automatic temperature control settings, and the extra rinse feature.

Starting the Wash

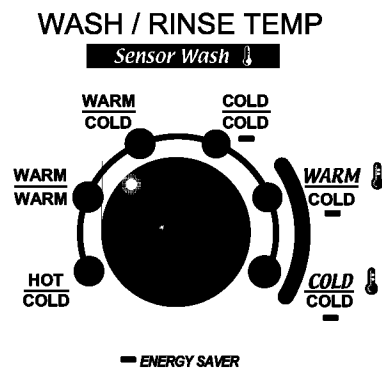

1. Prepare clothes for washing

For best wash results:

- Remove items from pockets and cuffs
- Close zippers and fasteners; mend rips and tears
- Sort items into separate loads
- Pre-treat stains and heavily soiled areas

2. Select WASH/RINSE temperature

Always follow garment manufacturer's care labels for each fabric. See chart below.

WASH/ RINSE	TYPE OF CLOTHING
Hot/Cold	Sturdy whites and colorfast items; work clothes, soiled items and cloth diapers
Warm/Warm	Delicate or colorfast items
Warm/Cold	Moderately soiled permanent press or rinsing of most items; silks, woolens, nylon, acrylic
Cold/Cold	Colors that tend to bleed or fade, extra-delicate clothing, or rinsing of most items
Sensor Wash* 100°F(56°C)Warm/Cold	Delicate or colorfast items
Sensor Wash* 75°F(42°C)Cold/Cold	Colors that tend to bleed or fade, extra-delicate clothing, or rinsing of most items

* Sensor Wash temperatures may vary slightly.

3. Select LOAD SIZE / WATER LEVEL

Variable control allows you to select the most appropriate setting for each wash load. Do not fill above top row of holes in tub with clothes. Use Water Level chart to determine setting.

NOTE: If washing delicates, a full tub is recommended for any size load. This reduces fabric wear and wrinkling.

If you need to change water level after tub has started to fill turn knob to **RESET** before selecting new level. If **RESET** is not selected, wash tub may flood.

LOAD SIZE	WATER LEVEL
Super Plus	Max. Fill
Ex-Large	$\frac{3}{4}$ Full
Large	$\frac{5}{8}$ – $\frac{3}{4}$ Full
Medium	$\frac{1}{2}$ – $\frac{5}{8}$ Full
Small	$\frac{1}{2}$ Full

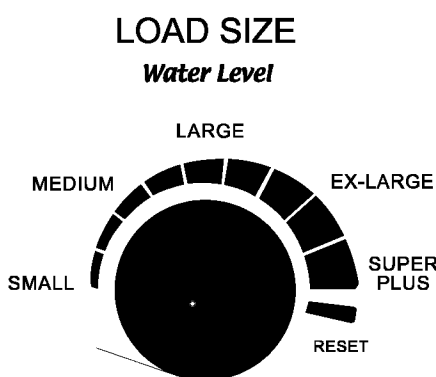

Starting the Wash (continued)

4. Select wash action by choosing your WASH OPTION and WASH CYCLE

- Choose the desired WASH OPTION appropriate to the soil level of the wash load.
- If extra rinse is desired, select the NORMAL or HEAVY SOILED option on the *with Extra Rinse* side of the dial.
- Timer knob can be turned in either direction. Wash cycle and time selection depends upon type of fabric and amount of soil.
- Always follow garment manufacturer's care labels for each fabric. See chart below.

FABRIC TYPE	WASH CYCLE	WASH / RINSE OPTION	AGITATION	SPIN SPEED
Light cottons • sheets • light colored shirts	WHITES	NORMAL	Regular	high
Heavy cottons • socks • underwear • towels	WHITES	HEAVY SOILED	Fast	high
Colored sturdy fabrics • permanent press • knits	COLORS	NORMAL	Regular	light
Colored sturdy fabrics • jeans • t-shirts	COLORS	HEAVY SOILED	Fast	high
Hand washed items • silks, • lingerie	DELICATES	NORMAL	Slow intermittent	light

5. Pull OUT timer knob to start

Water fill begins.

6. Measure and add detergent to wash tub

Use only detergent recommended for top-loading washers.

7. Add clothing to water in wash tub

- Do not pack clothes into tub. Loosely fill tub with clothes no higher than top row of holes. Items must move freely through water.

8. Adjust water level, if necessary.

- Bulky fabrics may need more water added after agitation begins. Turn Load Size knob to RESET and back to desired setting.

9. Close lid of unit

- Unit will not operate when lid is open.

Why does my agitation stop and start during the cycle?

Wash action consists of periods of agitation, with pauses or periods of soak. This is normal operation.

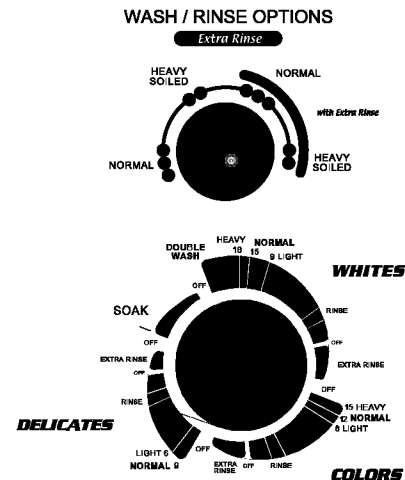

What if I want to use only the spin portion of my cycle?

This may be useful if you need to remove excessive moisture from hand-washed objects or just wanting to remove as much moisture as possible from your items.

To find the spin setting, locate the notch in the colored controls between the rinse cycle and the end of the cycle.

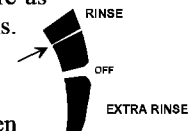

NOTE: Verify Extra Rinse feature is not active before selecting spin cycle.

What if I need to stop my washer while in cycle?

You may stop the washer at any time by pushing the cycle knob in. To restart, pull the knob out.

Make sure the lid of the unit is closed. Washer will not operate when lid is open.

IMPORTANT: Do not pause cycle for longer than 30 minutes. Internal pressure switch may reset and cause tub to overflow.

If cycle has been paused for more than 30 minutes, set your Cycle Dial to spin and set your wash cycle again.

Cycles and Features

What do the little numbers mean?

There are three methods used to clean your clothes: agitation, soaking periods, and spin/spray periods.

These are referred to as the *wash action* of the cycle. The numbers next to the cycles refer to the wash action time, or the time that the clothes are actually being cleaned.

These numbers do not include the time of the final rinse and final spin portion of the cycle.

DELICATES

WHITES

This cycle cares for sturdy cottons, such as towels, jeans, and socks. It also cares for lighter cottons such as underwear and t-shirts.

This cycle offers three levels of wash action:

- HEAVY: 18 minutes
- NORMAL: 15 minutes
- LIGHT: 9 minutes

COLORS

This cycle is designed to clean colored sturdy fabrics, as well as dress shirts, dress pants, business casuals, and synthetic blends.

This cycle offers three levels of wash action:

- HEAVY: 15 minutes
- NORMAL: 12 minutes
- LIGHT: 9 minutes

DELICATES

Designed to care for items such as blouses, nylons, lingerie, and other hand washables, this cycle features gentle wash action, including short periods of agitation and long periods of soaking.

This cycle offers two levels of wash action:

- NORMAL: 9 minutes
- LIGHT: 6 minutes

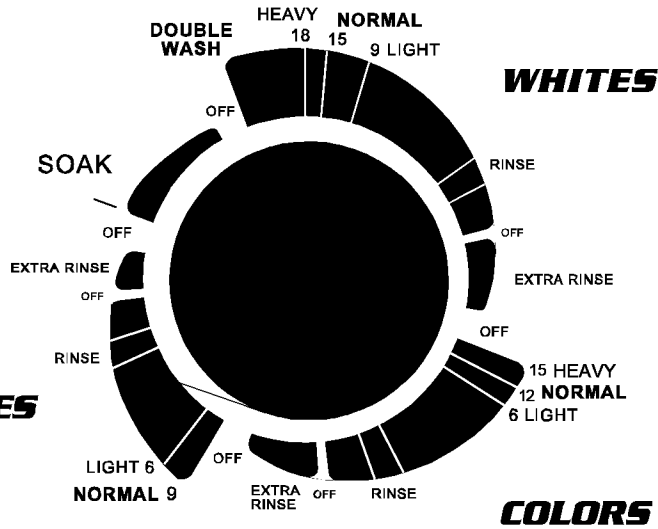

DOUBLE WASH

DOUBLE WASH automatically advances into the WHITES wash cycle. Use to wash heavily soiled clothes twice with detergent in each cycle.

To deliver extra detergent:

- LIQUID DETERGENT: place in fabric softener dispenser for use in second wash. *DO NOT use dispenser for fabric softener.*
- POWDER DETERGENT: place extra detergent in tub for use in first wash; recommend approximately 1½ times normal amount.

SOAK

Use for heavily soiled or stained items. Wash tub fills with water and agitates load for approximately 2 minutes before pausing approximately 12 minutes for soaking. After soaking period, the unit spins water out to complete cycle.

Sensor Wash

The washer features an automatic temperature control sensor that monitors the temperature of the water as it fills the wash tub.



This helps ensure detergents work to optimum cleaning levels while maintaining overall energy efficiency.

Once the tub begins to fill, the Sensor Wash sensor begins to measure the temperature of the water as it fills the tub. If the sensor recognizes that the water is too warm, then it allows cold water into the tub to drop the temperature. If the water is too cold, then it adds warm water to the tub. This process continues until the water reaches the chosen fill level. This assures that warm water is maintained at approximately 100°F(56°C), and the cold water at approximately 75°F(42°C).

Extra Rinse

Extra Rinse is useful for people with detergent sensitive skin. It provides a second complete rinse to more completely remove laundry additives, suds, and perfumes. Extra Rinse adds 10–15 minutes to total cycle time.

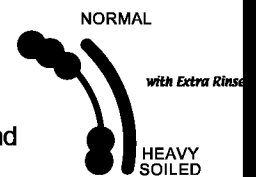

Dispensers

Bleach Dispenser

Bleach dispenser is located in left front corner under loading door.

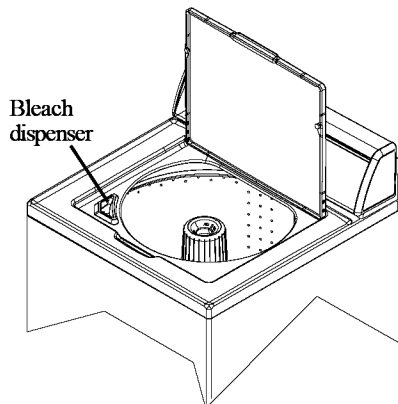

Use only liquid bleach in dispenser. To use powdered bleach, add to wash tub with detergent.

Carefully pour recommended amount of bleach into dispenser during first washer fill. See table.

Be careful not to spill undiluted bleach. It is a strong chemical and can damage cabinet finishes and some fabrics if not properly diluted. Follow bleach manufacturer's label for proper use.

LOAD SIZE	BLEACH (Max Amt.)
SUPER PLUS	1 cup
X-LARGE	1 cup
LARGE	1 cup
MEDIUM	$\frac{3}{4}$ cup
SMALL	$\frac{1}{2}$ cup

Fabric Softener Dispenser

Fabric softener dispenser is located on top of agitator. Dispenser automatically releases liquid fabric softener at proper time during rinse cycle.

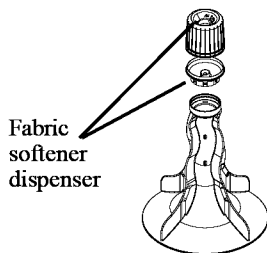

Fabric Softener Use Tips

- Liquid fabric softeners are dispensed during final rinse. Do not combine with bleach, bluing, starch, detergents, soaps, or packaged water conditioners during rinse.
- Do not use fabric softener in dispenser during DOUBLE WASH cycle.
- Do not mix powdered detergent with liquid softener in dispenser or softener will become gummy.

To use dispenser, follow these steps:

1. Pour liquid fabric softener into dispenser, using amount recommended on package.
2. Add water up to fill level, but do not exceed tip of fill arrow indicator. **FABRIC SOFTENER MUST BE DILUTED FOR USE.**
 - Do not stop washer during first spin or dispenser will empty too soon.
 - Never pour fabric softener directly onto clothes or spots and stains may result. To remove softener stains, soak in soapy solution of Sard™ Wonder Soap or Ivory™ soap, or rub stain with bar of Sard™ or Ivory™ soap and wash garment as usual.
 - For best softener performance, set water level to medium or higher.

3. **Clean softener dispenser after each use.** Remove dispenser housing from agitator by squeezing lower part of dispenser and pulling up on housing while tilting slightly to expose dispenser cup. Rinse dispenser housing and cup in hot soapy water.

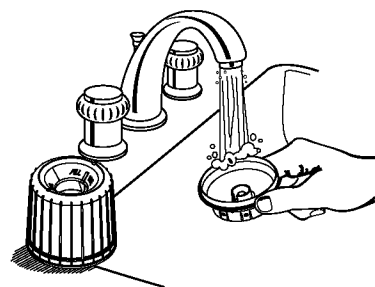

Clean funnel shape in top of agitator and inside of agitator. Use small brush on hole and slots in two funnel rings for thorough cleaning.

After cleaning, re-install dispenser cup. Push dispenser housing directly down onto top of agitator until firmly snapped together.

To prevent build-up, fill dispenser with clean water in wash cycles when not using softener.

Features, Hints, and Care

Follow the Colors

Your washer control panel is color coordinated for your convenience. When you set your washer controls, notice which colors are the same. They will help guide you through setting the controls.

Need more Time? Reset the Timer Knob.

Although wash cycles are automatic, timer may be reset to lengthen, shorten, or repeat a portion of a cycle. To set or reset timer, push in timer knob to stop washer. Hold in timer knob firmly while slowly turning it to desired setting. Pull out timer knob to start washer.

Stops and Starts

Wash action consists of periods of agitation, with pauses or periods of soaking. For best results, do not turn timer through pauses, which are normal part of wash cycles.

Cleaner Clothes

Water temperature affects how clean clothes become. If your clothes are not as clean as you would like, you may need to raise the temperature on your water heater. Check your water heater manufacturer's recommendations, as well as local codes, for assistance. Also, check that your water hoses are hooked up correctly. If they are switched you might be getting cold water in your warm and hot cycles.

Hard water does not remove soil as well as soft water. Check with your local water company to see if you have hard water. If you have hard water, try softening it with a packaged conditioner or use a little more detergent.

Risers

Risers or air cushions may be installed if pipes knock or pound when flow of water stops. Risers are more efficient when installed as close as possible to water supply faucets.

Lint Filter

Amana's self cleaning lint filter works throughout the wash cycle to constantly remove lint and other residue from the water. Located between the outer and inner tub, the lint filter removes lint as water passes from the bottom of the outer tub back to the inner tub. As water passes from the outer tub to the inner tub, water is forced through the bottom of the lint filter. The filter traps lint under the filter until the spin cycle begins. During the spin cycle centrifugal force removes the lint by pulling it off the bottom of the filter and washing it down the drain.

Motor Overload Protector

Internal overload protector automatically stops motor in event of overload. Overload protector resets in approximately 3 minutes and motor automatically restarts. If overload protector stops motor again, stop using washer and call service technician. Loading wash tub too full may result in motor overload.

Automatic Balance System

Your new washer will automatically adjust to unbalanced loads without shutting down or interrupting the cycle. The cycle will automatically complete at the fastest spin speed possible.

In a severe out-of-balance condition, clothes may contain excessive moisture. If this should happen, simply redistribute the clothes, and reset the control to the spin mark after the rinse setting in the regular cycle.

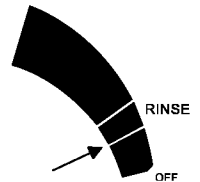

Safety Lid Switch

The washer will not spin when the lid is open for any reason. This is for your personal safety. If the lid is opened mid-cycle, operation will automatically start when lid is closed.

General Washer Care

- Use only damp or sudsy cloth for cleaning control panel. Some cleaning product sprays may harm control panel finish or may damage interior of hood.
- Wipe washer cabinet as needed. If detergent, bleach, or other washing products are spilled on cabinet, wipe immediately. Some products will cause permanent damage if spilled on cabinet.
- Top of washer should not be used for removing garment stains. Some stain removers, such as rust remover, may damage cabinet finish.
- Do not use scouring pads or abrasive cleansers.
- Do not lay sharp or rough objects on or against washer. Finish could be damaged.
- Remove pins, buckles, or other sharp objects from clothes to prevent scratching interior parts.
- Leave lid open after use to allow inside of washer to dry, and to help prevent musty odors from developing.
- Do not allow small children to play on or around washer.
- Do not move washer without reinstalling shipping brace (Part #40068201) and shipping plug (Part #40047301). See *Moving Washer to New Location* section.

Moving and Storage

Cold Storage and Non-Use Periods

WARNING

Explosive hydrogen gas may be produced in a hot water system that has not been used for two weeks or more. Before using washer, if hot water system has not been used for such a period, turn on all hot water faucets and let water flow for several minutes to release accumulated hydrogen gas. Hydrogen gas is flammable: Do not smoke or use an open flame when flushing water lines.

Cold Weather Care

If washer is delivered when outside temperature is below freezing or if washer is stored in unheated room or area during cold months, **do not operate until washer has warmed to room temperature. Do not install or operate washer where temperatures will drop below freezing.**

Cold Weather Storage

If washer must be stored in seasonal home or storage building, use one of the following storage methods.

METHOD 1

1. Turn off water supply faucets and disconnect hoses. Drain water from both hoses.
2. Add one gallon of non-toxic RV antifreeze (available from hardware or recreational vehicle dealers) to washer tub.
3. Push in cycle selector knob and turn to SPIN.
4. Pull knob out and let washer spin for 1–2 minutes to drain water. Some antifreeze will also be lost. (If you have a septic system, contact antifreeze manufacturer and make sure it will not harm system.)
5. Push in cycle selector knob to stop washer. Dry inner wash tub, disconnect electrical plug, and close washer lid. If moving washer, disconnect drain hose. Move and store washer **ONLY** in upright position. To remove antifreeze after storage, run washer through a complete cycle using ½ cup of detergent. **DO NOT ADD CLOTHES TO CYCLE.**

METHOD 2

1. Push in cycle selector knob and turn to SPIN. Run through complete spin cycle to remove excess water.
2. When spin cycle is complete, push in cycle selector knob to stop washer.
3. Turn off water supply faucets and disconnect hoses. Drain water from both hoses.
4. Dry inner wash tub, disconnect electrical plug, and close washer lid. If moving washer, disconnect drain hose. Move and store washer **ONLY** in upright position.
5. It is normal for some water to remain inside pump. To prevent damage to washer and pump if remaining water freezes, allow washer to warm to 24 to 48 hours after removing from storage, so water can thaw before use.

Vacations and Extended Non-Use

IMPORTANT: To avoid possible property damage from flooding, turn off water supply to washer during extended periods of non-use.

To prevent mold or mildew, leave lid open so moisture inside machine can evaporate.

When closing your home for extended periods, have service technician drain washer to avoid stagnant water.

Unplug cord from electrical outlet.

Disconnect hoses from faucets.

Moving Washer to New Location

Replace shipping plug under motor and shipping brace in tub. Refer to *Installation Instructions* for proper procedures whenever washer is moved. See illustration.

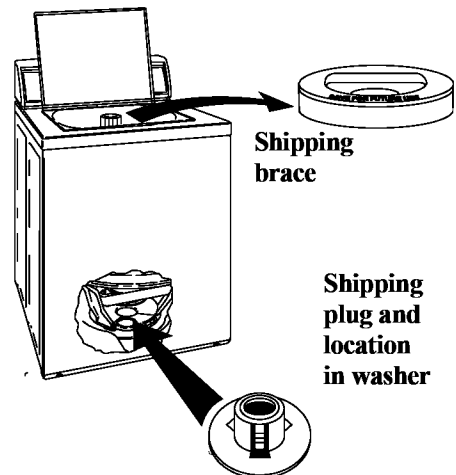

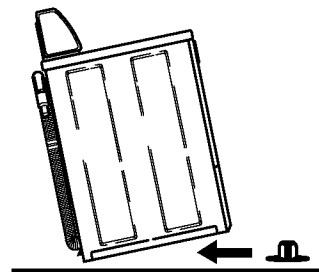

Tilt the washer back slightly and slide shipping plug into position under washer.



Trouble Shooting

You may save time and money by checking items below before calling for service. List includes common concerns that are not the result of defective workmanship or materials. If your question is not explained below, contact Amana Consumer Affairs Department at 1 (800) 843-0304.

TOPIC	POSSIBLE CAUSE	SOLUTION
NOISE 		
Gear sounds or a low hum	Normal mechanical sounds in commercial-quality washer	Normal operation.
Rattling and clanking noise	Loose objects, such as coins or pins, in tub or pump. Clothing fasteners hitting wash tub.	Stop washer and check tub. Remove loose objects. Close zippers, buttons and fasteners. Clothing with buckles must be turned inside out. If noise continues after washer is restarted, objects may be in pump: Call your authorized servicer.
Squealing sound or hot rubber odor	Overloaded wash tub	Largest dry load level should not be higher than bottom of fabric softener dispenser or top of agitator.
Thumping sound	Heavy wash loads; unbalanced loads	Usually normal, but unbalanced loads should be redistributed. Stop washer and rearrange load.
Vibrating noise	Washer not resting firmly on floor	Make sure floor is strong enough for washer. Adjust leveling legs so washer rests firmly on floor. See <i>Installation Instructions</i> for leveling details.
	Wash load distributed unevenly in tub	Stop washer and rearrange load.
	Shipping plug not removed during installation	See <i>Installation Instructions</i> for details on removing shipping plug.
Water splashing or slapping noise	Washer sprays water inside tub while running at high speed during rinse and spin.	Normal operation. Washer sprays water inside tub while running at high speed during rinse and spin.
Whistling or whirling noise	Drum spinning without clothes. Holes in the tub can cause this sound.	Normal operation.
OPERATION 		
Washer does not start	Electrical power cord may not be plugged in, or connection may be loose	Make sure plug from power cord fits tightly into wall outlet.
	Fuse blown, circuit breaker tripped, or power outage occurred	Replace fuse or reset circuit breaker. Do NOT increase fuse capacity. Call qualified electrician to correct circuit overload problem. Call local utility company to correct power outage.
	Water supply faucets not turned on	Turn on water supply faucets.
	Control set incorrectly	Reprogram control. See fault code explanations if necessary.
	Internal overload protector automatically stops motor in event of overload.	Protector resets in approximately 3 minutes and motor automatically restarts. If overload protector stops motor again, quit using washer and call service technician.
Washer won't spin	Lid partially open	Close lid completely.
Residue left in tub	Heavily soiled items	Before washing, shake or brush excess dirt and sand from items. Wipe tub with non-abrasive household cleaner and rinse.
Agitation stops and starts	Wash action consists of periods of agitation, with pauses or periods of no activity.	Pauses in the wash cycle are a normal and necessary occurrence

Trouble Shooting (continued)

TOPIC

POSSIBLE CAUSE

SOLUTION

WATER



Wash load too wet after spin	Overloaded wash tub	Largest dry load level should not be higher than bottom of fabric softener dispenser or top of agitator.
	Unbalanced load	Rearrange load to allow proper spin.
	Fabric naturally retains more moisture	Set controls for an extra cycle of spin. Locate the notch in the colored controls between the rinse cycle and the end of the cycle.
Water enters slowly or does not enter washer	Inadequate main water supply	Check water pressure at another faucet in house.
	Water supply faucets partly closed	Fully open hot and cold water supply faucets.
	Water being used elsewhere in house	Avoid running water elsewhere when washer is filling. Water pressure must be at least 20 psi (138 kPa).
	Clogged water inlet filters	Disconnect water fill hoses from faucet and clean screen filters. Replace filters and attach hoses..
	Kinked water inlet hoses	Straighten hoses.
Water level does not cover clothes	Incorrect water level selection	Turn Load Size knob to RESET and select a higher water level.
	Overloaded wash tub	Largest dry load level should not be higher than bottom of fabric softener dispenser or top of agitator.
Warm or hot water not hot enough	Water heater temperature set too low or positioned too far from washer	You may need to raise the temperature on your water heater. Check your water heater manufacturer's recommendations, as well as local codes for assistance. Use Sensor Wash temperature settings. Sensor Wash regulates warm wash water fill to be approximately 100°F(75°C)
	Hot water being used elsewhere in house	Avoid using hot water elsewhere before or during washer use, or there may not be enough hot water for proper cleaning. If problem continues, enlarge capacity of hot water system, or use for only one application at a time.
Water drains slowly or does not drain	Drain hose kinked or clogged	Clean and straighten drain hose.
Water leaks	Loose fill hose connections	Check and tighten all hose/faucet connections. Install rubber sealing washers provided.
	Active cycle was paused for longer than 30 minutes and then reactivated.	Pressure switch will reset after 30 minutes, causing tub to fill once cycle is reactivated. This may cause tub to overflow if tub contains water. If cycle has been paused for more than 30 minutes, set Cycle Dial to SPIN to drain out existing water.
	Water level setting was changed without turning knob to RESET	Always turn Load Level knob to RESET before changing water level settings.
	Load Level knob was held at RESET.	Water will continue to fill as long as knob is held at RESET and may result in overflow. Do not hold knob at RESET.
	Clogged drain pipes	Unclog drain pipes. Call plumber if necessary.
	Oversudsing	Use less detergent.
Incorrect wash and rinse temperatures	Hot and cold water hoses connected to wrong supply faucets	Check hose connections. Connect hot water hose to hot water faucet; connect cold water hose to cold water faucet.
Water enters washer, but tub does not fill	Incorrect standpipe height for drain hose	Recommended standpipe height is 36" (91.44 cm); for low standpipes, install Siphon Break Kit (part #562P3). See <i>Installation Instructions</i> for details.
Water flow during fill varies	Normal operation of Sensor Wash feature	Normal water flow regulation by the Sensor Wash feature causes water flow to switch from hot to cold.

Amana Washer Warranty

Full ONE Year Warranty

For one (1) year from the date of original retail purchase, Amana will repair or replace any part that fails due to a defect in materials or workmanship.

Limited Warranty

After one year from the date of original retail purchase, Amana will provide a free part, as listed below, to replace any part that fails due to a defect in materials or workmanship. The owner will be responsible for paying all other costs including labor, mileage, and transportation.

Second through Third Year

Amana will provide any part.

Third through Fifth Year

Amana will provide the drive motor or timer.

Third through Tenth Year

Amana will provide the transmission assembly and seal kit.

Amana will provide the outer tub assembly.

Amana will provide the cabinet assembly should the part rust through.

Amana will provide the outer wash tub should the part fail to contain water.

Lifetime

Amana will provide the inner wash basket.

What is not covered by these warranties

- Replacement of household fuses, resetting of circuit breakers, or correction to household wiring or plumbing.
- Products with original serial numbers removed, altered, or not readily determined.
- Products purchased for commercial, industrial, rental, or leased use.
- Products located outside of the United States or Canada.
- Premium service charges, if the servicer is requested to perform service in addition to normal service or outside normal service hours or area.
- Adjustments after the first year.
- Damage to clothing.

Repairs resulting from the following:

- Improper installation or maintenance.
- Any modification, alteration, or adjustment not authorized by Amana.
- Accident, misuse, abuse, fire, flood, or acts of nature.
- Connections to improper electrical current, voltage, or supply.

To Receive Warranty Service

Service must be performed by an authorized Amana service representative. To schedule service, contact the Amana dealer where you purchased your appliance or contact Amana Appliances Factory Service.

Amana Appliances Factory Service
1-800-628-5782 inside USA

**For more information,
Amana Appliances Consumer Services**
Amana Appliances
2800 220th Trail
Amana, Iowa 52204
1-800-843-0304 inside USA
(319) 622-5511 worldwide

When contacting Amana Appliances please include the following information:

- Your name, address, and telephone number.
- Model number and serial number of your appliance (found on inside of lid in the bottom right corner).
- The name and address of your dealer and the date of purchase.
- A clear description of the problem.
- Proof of purchase (sales receipt).

IN NO EVENT SHALL AMANA BE LIABLE FOR INCIDENTAL OR CONSEQUENTIAL DAMAGES.

This warranty gives you specific legal rights, and you may have others which vary from state to state. For example, some states do not allow the exclusion or limitation of incidental or consequential damages, so this exclusion may not apply to you.

