

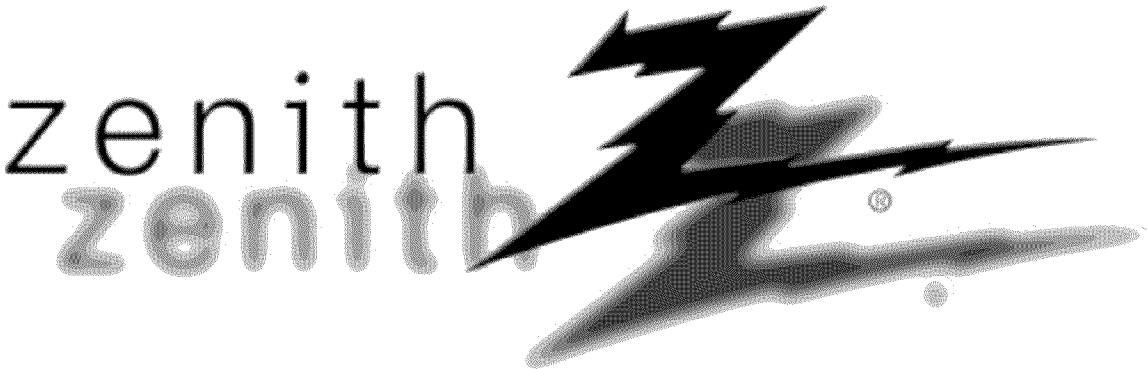

Installation and Operating Guide

Model Numbers | P60W38, P60W38H | PLASMA DISPLAY PANEL



Warning

	WARNING RISK OF ELECTRIC SHOCK DO NOT OPEN	
---	---	--

WARNING:
TO REDUCE THE RISK OF ELECTRIC SHOCK DO NOT REMOVE COVER (OR BACK). NO USER SERVICEABLE PARTS INSIDE. REFER TO QUALIFIED SERVICE PERSONNEL.

 The lightning flash with arrowhead symbol, within an equilateral triangle, is intended to alert the user to the presence of uninsulated "dangerous voltage" within the product's enclosure that may be of sufficient magnitude to constitute a risk of electric shock to persons.

 The exclamation point within an equilateral triangle is intended to alert the user to the presence of important operating and maintenance (servicing) instructions in the literature accompanying the appliance.

WARNING:

TO PREVENT FIRE OR SHOCK HAZARDS, DO NOT EXPOSE THIS PRODUCT TO RAIN OR MOISTURE.

FCC NOTICE

• A Class B digital device

This equipment has been tested and found to comply with the limits for a Class B digital device, pursuant to Part 15 of the FCC Rules. These limits are designed to provide reasonable protection against harmful interference in a residential installation. This equipment generates, uses and can radiate radio frequency energy and, if not installed and used in accordance with the instructions, may cause harmful interference to radio communications. However, there is no guarantee that interference will not occur in a particular installation. If this equipment does cause harmful interference to radio or television reception, which can be determined by turning the equipment off and on, the user is encouraged to try to correct the interference by one or more of the following measures:

- Reorient or relocate the receiving antenna.
- Increase the separation between the equipment and receiver.
- Connect the equipment into an outlet on a circuit different from that to which the receiver is connected.
- Consult the dealer or an experienced radio/TV technician for help.

• Any changes or modifications not expressly approved by the party responsible for compliance could void the user's authority to operate the equipment.

CAUTION:

Do not attempt to modify this product in any way without written authorization from Zenith Electronics Corporation. Unauthorized modification could void the user's authority to operate this product.

COMPLIANCE:

The responsible party for this product's compliance is:
Zenith Electronics Corporation
2000 Millbrook Drive
Lincolnshire, IL 60069, USA
Phone: 1-847-941-8000

WARNING

TO REDUCE THE RISK OF FIRE AND ELECTRIC SHOCK, DO NOT EXPOSE THIS PRODUCT TO RAIN OR MOISTURE.

Safety Instructions

Important safeguards for you and your new product

Your product has been manufactured and tested with your safety in mind. However, improper use can result in potential electrical shock or fire hazards. To avoid defeating the safeguards that have been built into your new product, please read and observe the following safety points when installing and using your new product, and save them for future reference.

Observing the simple precautions discussed in this manual can help you get the many years of enjoyment and safe operation that are built into your new product.

This product complies with all applicable U.S. Federal safety requirements, and those of the Canadian Standards Association.

1. Read Instructions

All the safety and operating instructions should be read before the product is operated.

2. Follow Instructions

All operating and use instructions should be followed.

3. Retain Instructions

The safety and operating instructions should be retained for future reference.

4. Heed Warnings

All warnings on the product and in the operating instructions should be adhered to.

5. Cleaning

Unplug this product from the wall outlet before cleaning. Do not use liquid cleaners or aerosol cleaners. Use a damp cloth for cleaning.

6. Water and Moisture

Do not use this product near water, for example, near a bath tub, wash bowl, kitchen sink, or laundry tub, in a wet basement, or near a swimming pool.

7. Accessories, Carts, and Stands

Do not place this product on a slippery or tilted surface, or on an unstable cart, stand, tripod, bracket, or table. The product may slide or fall, causing serious injury to a child or adult, and serious damage to the product. Use only with a cart, stand, tripod, bracket, or table recommended by the manufacturer, or sold with the product. Any mounting of the product should follow the manufacturer's instructions, and should use a mounting accessory recommended by the manufacturer.

8. Transporting Product

A product and cart combination should be moved with care. Quick stops, excessive force, and uneven surfaces may cause the product and cart combination to overturn.

9. Attachments

Do not use attachments not recommended by the product manufacturer as they may cause hazards.

10. Ventilation

Slots and openings in the cabinet are provided for ventilation and to ensure reliable operation of the product and to protect it from overheating, and these openings must not be blocked or covered. The openings should never be blocked by placing the product on a bed, sofa, rug, or other similar surface. This product should not be placed in a built-in installation such as a bookcase or rack unless proper ventilation is provided or the manufacturer's instructions have been adhered to.

11. Power Sources

This product should be operated only from the type of power source indicated on the marking label. If you are not sure of the type of power supply to your home, consult your product dealer or local power company. For products intended to operate from battery power, or other sources, refer to the operating instructions.

12. Power-Cord Polarization

This product is equipped with a three-wire grounding type plug, a plug having a third (grounding) pin. This plug will only fit into the grounding-type power outlet. This is a safety feature. If you are unable to insert the plug into the outlet, contact your electrician to replace your obsolete outlet. Do not defeat the safety purpose of the grounding-type plug.

13. Power-Cord Protection

Power-supply cords should be routed so that they are not likely to be walked on or pinched by items placed upon or against them, paying particular attention to cords at plugs, convenience receptacles, and the point where they exit from the product.



PORTABLE CART WARNING

Safety Instructions continued

14. Outdoor Antenna Grounding

If an outside antenna or cable system is connected to the product, be sure the antenna or cable system is grounded so as to provide some protection against voltage surges and built-up static charges. Article 810 of the National Electrical Code (U.S.A.), ANSI/ NFPA 70 provides information with regard to proper grounding of the mast and supporting structure, grounding of the lead-in wire to an antenna discharge unit, size of grounding conductors, location of antenna-discharge unit, connection to grounding electrodes, and requirements for the grounding electrode.

Example of Grounding According to National Electrical Code Instructions

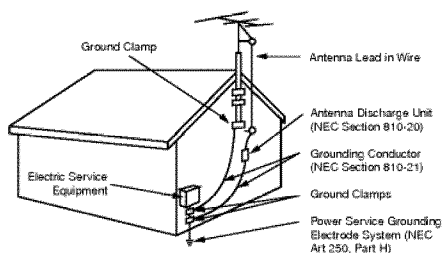

NEC - National Electrical Code

15. Lightning

For added protection for this product (receiver) during a lightning storm, or when it is left unattended and unused for long periods of time, unplug it from the wall outlet and disconnect the antenna or cable system. This will prevent damage to the product due to lightning and power-line surges.

16. Power Lines

An outside antenna system should not be located in the vicinity of overhead power lines or other electric light or power circuits, or where it can fall into such power lines or circuits. When installing an outside antenna system, extreme care should be taken to keep from touching such power lines or circuits as contact with them might be fatal.

17. Overloading

Do not overload wall outlets and extension cords as this can result in a risk of fire or electric shock.

18. Object and Liquid Entry

Never push objects of any kind into this product through openings as they may touch dangerous voltage points or short-out parts that could result in a fire or electric shock. Never spill liquid of any kind on the product.

19. Servicing

Do not attempt to service this product yourself as opening or removing covers may expose you to dangerous voltage or other hazards. Refer all servicing to qualified service personnel.

20. Damage Requiring Service

Unplug this product from the wall outlet and refer servicing to qualified service personnel under the following conditions:

- If the power-supply cord or plug is damaged.
- If liquid has been spilled, or objects have fallen into the product.
- If the product has been exposed to rain or water.
- If the product does not operate normally by following the operating instructions. Adjust only those controls that are covered by the operating instructions as an improper adjustment of other controls may result in damage and will often require extensive work by a qualified technician to restore the product to its normal operation.
- If the product has been dropped or the cabinet has been damaged.
- If the product exhibits a distinct change in performance.

21. Replacement Parts

When replacement parts are required, be sure the service technician has used replacement parts specified by the manufacturer or have the same characteristics as the original part. Unauthorized substitutions may result in fire, electric shock, or other hazards.

22. Safety Check

Upon completion of any service or repairs to this product, ask the service technician to perform safety checks to determine that the product is in proper operating condition.

23. Wall or Ceiling Mounting

The product should be mounted to a wall or ceiling only as recommended by the manufacturer. The product may slide or fall, causing serious injury to a child or adult, and serious damage to the product.

24. Heat

The product should be situated away from heat sources such as radiators, heat registers, stoves, or other products (including amplifiers) that produce heat.

Contents

Warnings	2	Screen Menu Options	
Safety Instructions	3~4	Auto Adjustment	20
Introduction		Setting Picture Format	20
Controls and Connection Options	7	Picture Size Zoom	20
Remote Control Key Functions	8	Split Zoom	21
Installation		Screen Position	21
Installation Instructions	9~10	Manual Configure	21
External Equipment Connections	11~14	Screen Adjustments	22
VCR Setup	11	Initializing	22
Cable TV Setup	11	Selecting Wide VGA/XGA mode	22
External A/V Source Setup	12	Luminance Noise Reduction	22
DVD Setup	12	PIP (Picture-in-Picture) Feature	
DTV Setup	12	Watching PIP	23
PC Setup	13~14	PIP Size	23
Operation		PIP Aspect Ratio	23
Turning on the Monitor	15	Swapping PIP	23
Menu Language Selection	15	Moving PIP	23
Video Menu Options		Selecting an Input Signal Source for PIP	23
APC (Auto Picture Control)	16	Twin Picture Setup Options	
Manual Picture Control	16	Watching Twin Picture	24
Auto Color Temperature Control	16	Sub Picture Size Adjustment	24
Manual Color Temperature Control	16	Swapping the Twin Picture	24
Audio Menu Options		Selecting a Source for the Twin Picture	24
DASP (Digital Auto Sound Processing)	17	External Control Device Setup	25~30
Manual Sound Control	17	IR Code Information	31~32
AVL (Auto Volume Leveler)	17	Troubleshooting Checklist	33
Time Menu Options		Maintenance	34
Clock Setup	18	Specifications	34
On/Off Timer Setup	18	Your Zenith Limited Warranty	35~36
Auto Off	18		
Sleep Timer	18		
Special Menu Options			
Key Lock	19		
ISM Method	19		
Low power	19		
Menu Rotation For Vertical Viewing	19		

Setup and Operation Checklist

Setup and Operation Checklist
(See pages 11~13 for available connection and operational setup options.)

1. Unpack Monitor and all accessories.
2. Connect all external video and audio equipment.
see pages 11 ~ 13.
3. Install batteries in remote control.
See page 8.
4. Turn Monitor on.
See page 15.
5. Turn video source equipment on.
6. Select viewing source for Monitor.
See page 8.
7. Fine-tune source image and sound to personal preference
or as required by source.
See pages 16 ~ 17.
8. Additional features Setup
See Contents above.

After reading this manual, keep it handy for future reference.

Introduction

What is a Plasma Display Panel (PDP)?

If voltage is applied to gas within glass panels, ultraviolet rays are produced and fused with a fluorescent substance. At that instant, light is emitted. A Plasma Display is a next generation flat Display using this phenomenon.

160° - Wide angle range of vision

Your flat panel plasma screen offers an exceptionally broad viewing angle -- over 160 degrees. This means that the display is clear and visible to viewers who can see the screen anywhere in the room.

Wide Screen

The screen of the Plasma Display is 60" so wide that your viewing experience is as if you are in a theater.

Multimedia

Connect your plasma display to a PC and you can use it for conferencing, games, and internet browsing. The Picture-in-Picture feature allows you to view your PC and video images simultaneously.

Versatile

The light weight and thin size makes it easy to install your plasma display in a variety of locations where conventional TVs would not fit.

The PDP Manufacturing Process: Why minute colored dots may be present on the PDP screen

The PDP (Plasma Display Panel) which is the display device of this product is composed of 0.9 to 2.2 million cells. A few cell defects will normally occur in the PDP manufacturing process. Several minute colored dots visible on the screen should be acceptable. This also occurs in other PDP manufacturers' products and the tiny dots appearing does not mean that this PDP is defective. Thus a few cell defects are not sufficient cause for the PDP to be exchanged or returned. Our production technology is designed to minimize cell defects during the manufacture and operation of this product.

Cooling Fan Noise

In the same way that a fan is used in a PC computer to keep the CPU (Central Processing Unit) cool, the PDP is equipped with cooling fans to cool the Monitor and improve its reliability. Therefore, a certain level of noise could occur while the fans are operating and cooling the PDP.

The fan noise doesn't have any negative effect on the PDP's efficiency or reliability. The noise from these fans is normal during the operation of this product. We hope you understand that a certain level of noise from the cooling fans is acceptable and is not sufficient cause for the PDP to be exchanged or returned.

Controls

Front Panel Controls

- This is a simplified representation of a typical front panel.

The Front Panel Controls shown here may be somewhat different from your monitor.

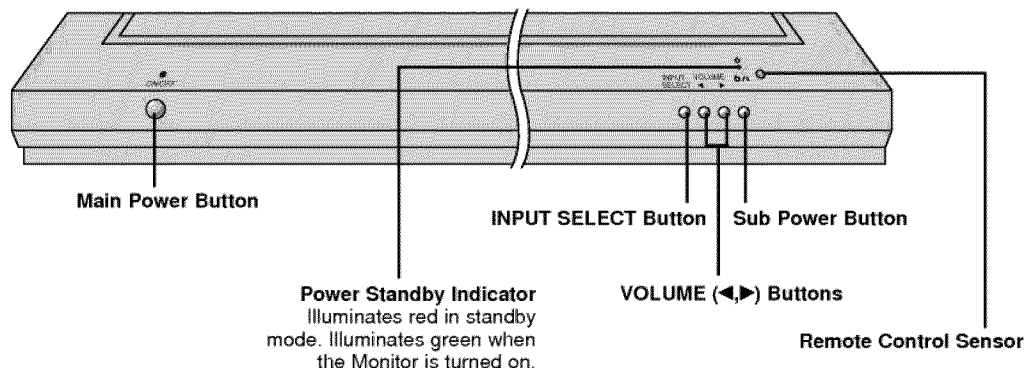

Connection Options

Back Connection Panel

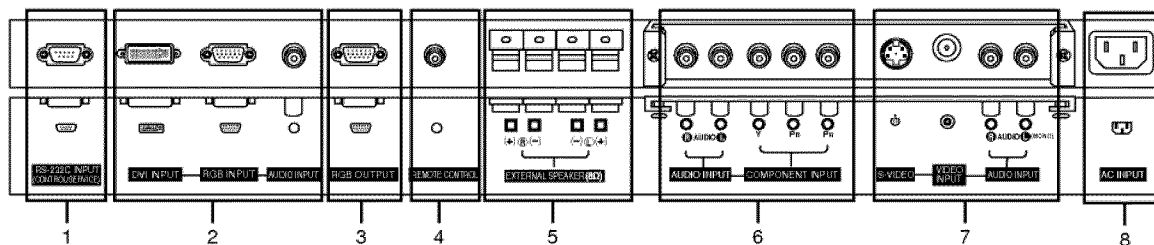

1. **RS-232C INPUT (CONTROL/SERVICE) PORT**
Connect to the RS-232C port on a PC.
2. **DVI (Digital Visual Interface) INPUT/RGB INPUT/AUDIO INPUT JACKS**
Connect the monitor output connector from a PC to the appropriate input port.
3. **RGB OUTPUT PORT**
You can watch the RGB signal on another monitor, connect RGB OUTPUT to another monitor's PC input port.
4. **REMOTE CONTROL**
Connect your wired remote control to the remote control port on the Monitor.
5. **EXTERNAL SPEAKER (8 ohm output)**
Connect to optional external speaker(s).
* For further information, refer to 'Speaker & Speaker Stand' manual.
6. **COMPONENT INPUT/AUDIO INPUT JACKS**
Connect a component video/audio device to these jacks.
7. **S-VIDEO INPUTS**
Connect S-Video out from an S-VIDEO VCR or other S-Video device to the S-VIDEO input.
AUDIO/VIDEO INPUT JACKS
Connect audio/video out from external equipment to these jacks.
8. **POWER CORD SOCKET**
This Monitor operates on an AC power. The voltage is indicated on the Specifications page. Never attempt to operate the Monitor on DC power.

Remote Control Key Functions

- When using the remote control, aim it at the remote control sensor on the monitor.
- Under certain conditions such as if the remote IR signal is interrupted, the remote control may not function. Press the key again as necessary.

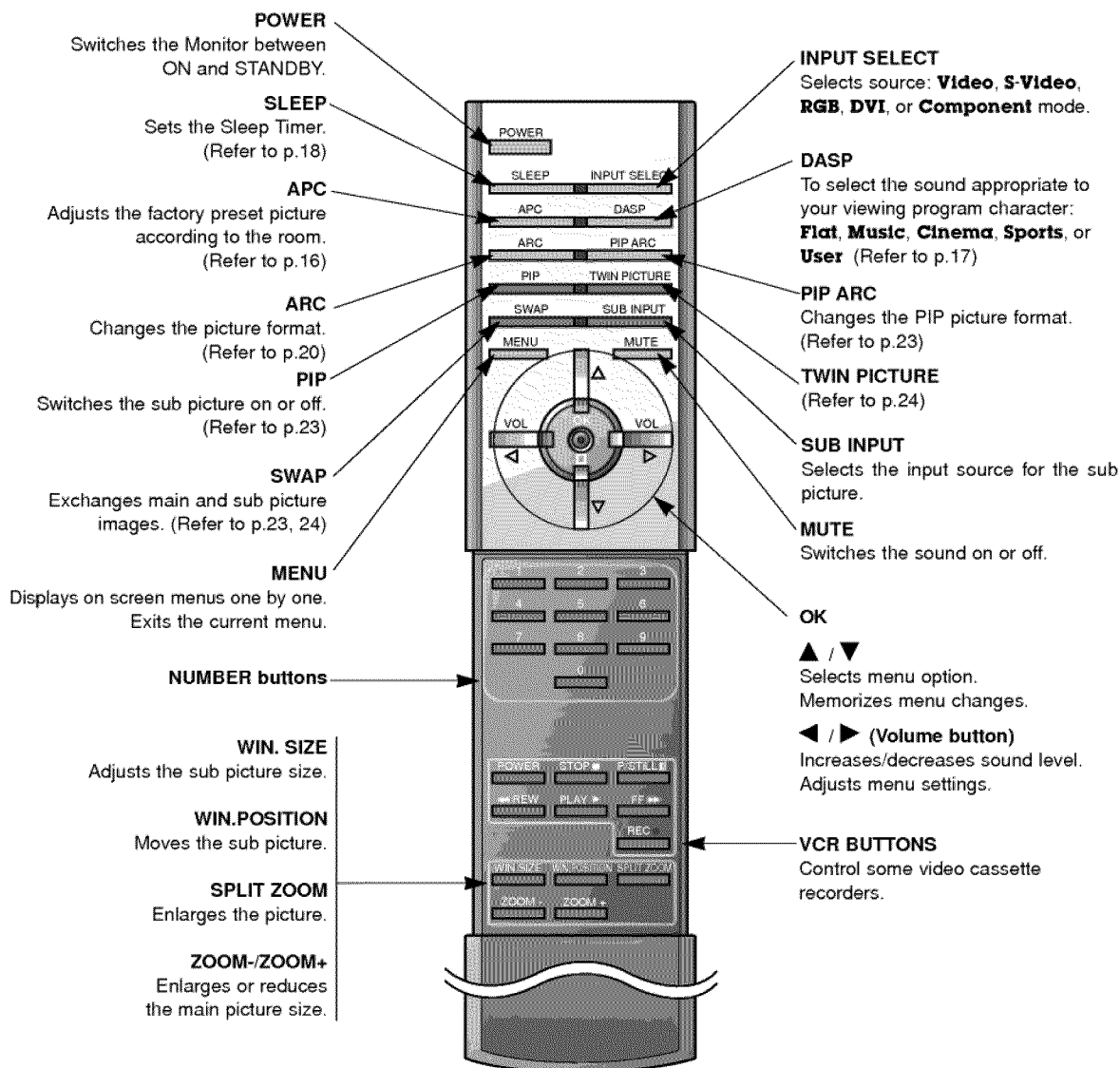

Installing Batteries

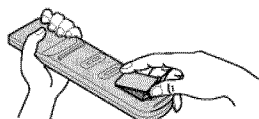

- Open the battery compartment cover on the back side and insert the batteries with correct polarity.
- Install two 1.5V alkaline batteries of AAA type. Don't mix used batteries with new batteries.

Installation

Ensure that the following accessories are included with your plasma display. If an accessory is missing, please contact the dealer where you purchased the product.

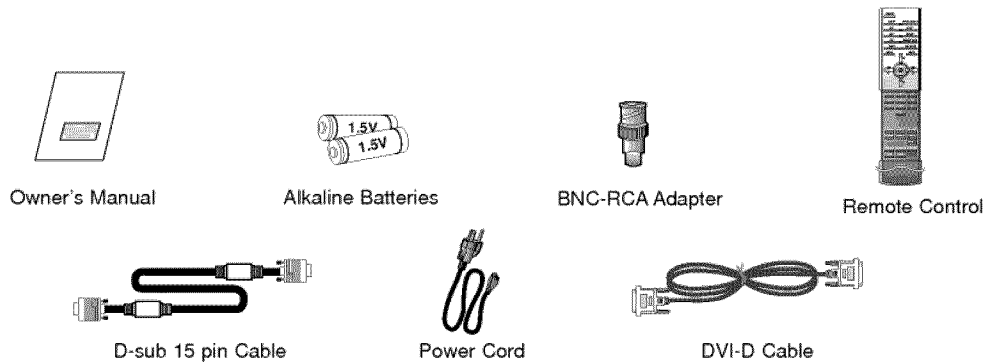

Installation Instructions

- The Monitor can be installed in various ways such as on a wall, or on a desktop etc.
- The plasma display is designed to be mounted horizontally or vertically. The speakers shown are optional.

GROUNDING

Ensure that you connect the grounding / earth wire to prevent possible electric shock. If grounding methods are not possible, have a qualified electrician install a separate circuit breaker. Do not try to ground the unit by connecting it to telephone wires, lightening rods, or gas pipes.

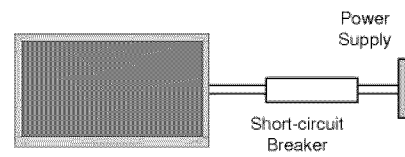

Wall Mount Installation

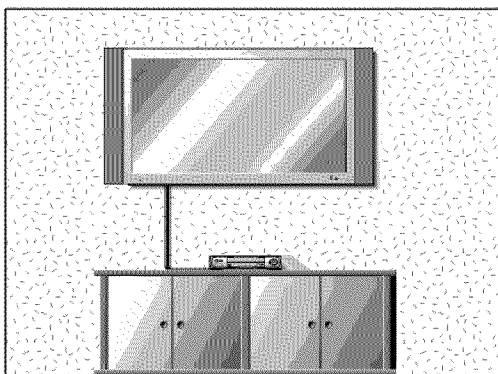

For proper ventilation, allow a clearance of 4" on each side and 2" from the wall. Detailed installation instructions are available from your dealer, see the optional Wall Mounting Bracket Installation and Setup Guide.

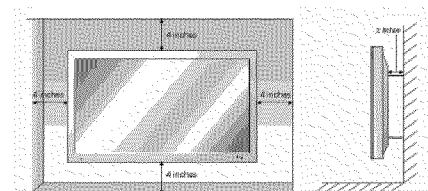

Installation Instructions continued

Desktop Pedestal Installation

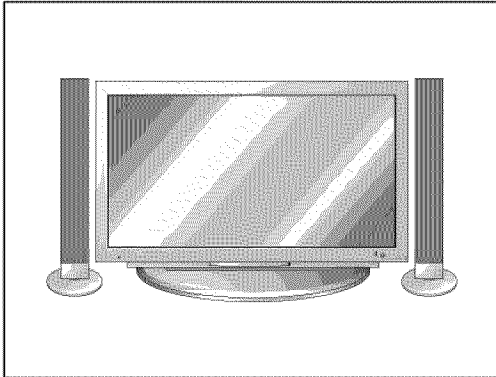

For proper ventilation, allow a clearance of 4" on each side and the top, 2.36" on the bottom, and 2" from the wall. Detailed installation instructions are included in the optional Desktop Stand Installation and Setup Guide available from your dealer.

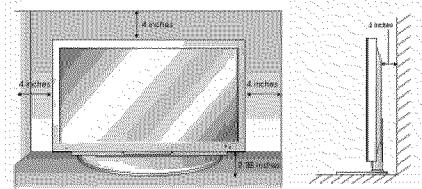

Wall Mount: Vertical installation

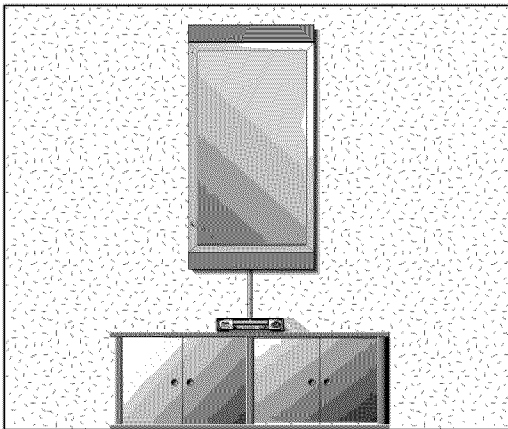

Detailed installation instructions are included in the optional Vertical Wall Mounting Bracket Installation and Setup Guide available from your dealer.

NOTE: When installing the monitor vertically, the front panel controls must be in the left side position.



When installing the monitor vertically, you have to change the OSD display mode so that the menus will appear correctly and also to protect the monitor from overheating (Refer to P. 19).

External Equipment Connections

NOTE: Not all cables shown are included with the plasma display.

VCR Setup

- To avoid picture noise (interference), leave an adequate distance between the VCR and Monitor.
- Use the ISM Method feature to avoid having a fixed image remain on the screen for a long period of time. Typically a frozen still picture from a VCR. If the 4:3 picture format is used; the fixed image, shown at the sides of the screen, may remain visible on the screen.

How to connect

1. Connect the provided BNC-RCA adapter to the monitor's VIDEO INPUT.
2. Connect the audio and video cables from the VCR's output jacks to the monitor input jacks, as shown in the figure.
When connecting the monitor to VCR, match the jack colors (Video = yellow, Audio Left = white, and Audio Right = red).

Mono VCR: Connect the video output cable from the VCR to the VIDEO input on the monitor.

S-VIDEO VCR: Connect the S-Video output cable from the VCR to the S-VIDEO input on the monitor. (Note that S-Video offers higher quality).

How to use

1. Insert a video tape into the VCR and press PLAY on the VCR.
(Refer to the VCR owner's manual.)
2. Use the **INPUT SELECT** button on the remote control to select **Video**.
(If connected to S-VIDEO, select the **S-Video** input source.)

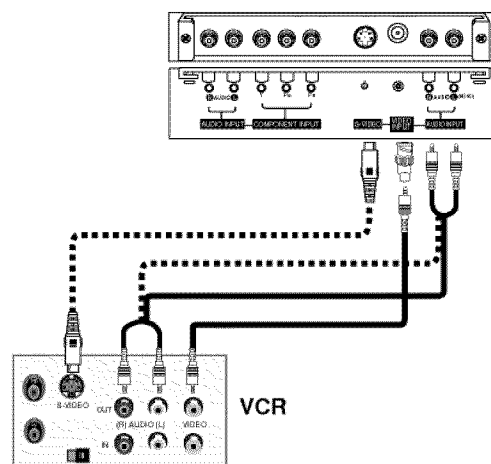

Cable TV Setup

- After subscribing to a cable TV service from a local provider and installing a converter, you can watch cable TV programming. The monitor cannot display TV programming unless a TV tuner device or cable TV converter box is connected to the Monitor.
- For further information regarding cable TV service, contact your local cable TV service provider(s).

How to connect

1. Connect the provided BNC-RCA adapter to the monitor's VIDEO INPUT.
2. Connect the audio and video cables from the Cable Box's output jacks to the monitor input jacks, as shown in the figure.
When connecting the monitor to a Cable Box, match the jack colors (Video = yellow, Audio Left = white, and Audio Right = red).

How to use

1. Use the **INPUT SELECT** button on the remote control to select **Video**.
2. Select your desired channel with the remote control for cable box.

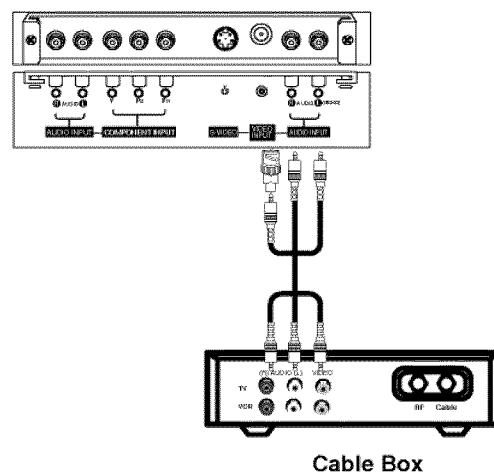

External A/V Source Setup

How to connect

1. Connect the provided BNC-RCA adapter to the monitor's VIDEO INPUT.
2. Connect the audio and video cables from the external equipment's output jacks to the monitor input jacks, as shown in the figure.

When connecting the monitor to external equipment, match the jack colors (Video = yellow, Audio Left = white, and Audio Right = red).

How to use

1. Use the **INPUT SELECT** button on the remote control to select **Video**.
2. Operate the corresponding external equipment. Refer to external equipment operating guide.

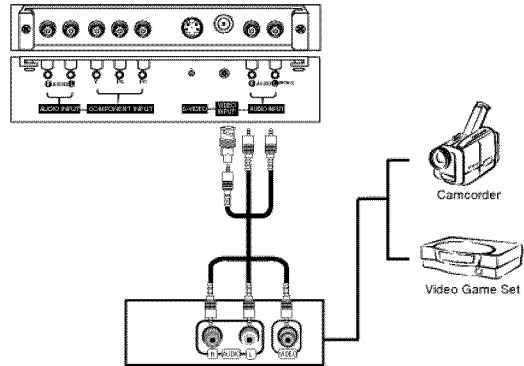

DVD Setup

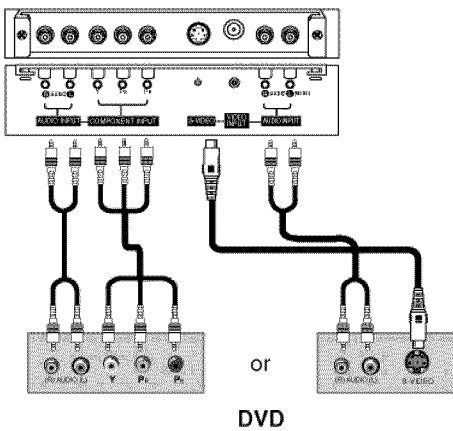

How to connect

1. Connect the DVD video outputs to the COMPONENT (Y, Pb, Pr) INPUT jacks and connect the DVD audio outputs to the AUDIO INPUT jacks on the monitor, as shown in the figure.
2. If your DVD only has an S-Video output jack, connect this to the S-VIDEO input on the monitor and connect the DVD audio outputs to the AUDIO INPUT jacks on the monitor, as shown in the figure.

How to use

1. Turn on the DVD player, insert a DVD.
2. Use the **INPUT SELECT** button on the remote control to select **Component**. (If connected to S-VIDEO, select the **S-Video** external input source.)
3. Refer to the DVD player's manual for operating instructions.

• Component input ports

To get better picture quality, connect a DVD player to the component input ports as shown below.

Component ports of the Monitor	Y	Pb	Pr
Video output ports of DVD player	Y	Pb	Pr
	Y	B-Y	R-Y
	Y	Cb	Cr
	Y	PB	PR

DTV Setup

- To watch digitally broadcast programs, purchase and connect a digital set-top box.
- This monitor supports HDCP (High-bandwidth Digital Contents Protection) protocol for DVI DTV (480p, 720p, 1080i) mode.

How to connect

1. Use the monitor's COMPONENT (Y, Pb, Pr) INPUT, RGB or DVI jack for video connections, depending on your set-top box connector. Then, make the corresponding audio connections.

How to use

1. Turn on the digital set-top box. (Refer to the owner's manual for the digital set-top box.)
2. Use **INPUT SELECT** on the remote control to select **Component**, **RGB**, or **DVI**.

Signal	Component	RGB-DTV, DVI-DTV
480i	Yes	No
480p	Yes	Yes
720p	Yes	Yes
1080i	Yes	Yes

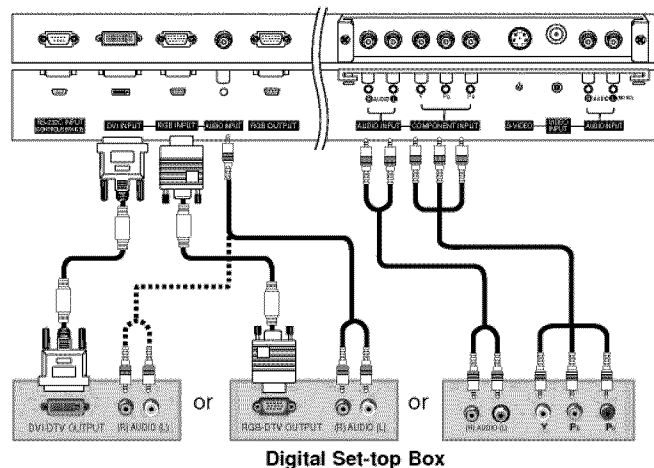

PC Setup

- This monitor provides Plug and Play capability, meaning that the PC adjusts automatically to its settings. The monitor sends configuration information (EDID) to the PC using the Video Electronics Standard Association (VESA) Display Data Channel (DDC) protocol.
- The monitor perceives 640x480, 60Hz as DTV 480p based on the PC graphic card. In this case, change the screen scanning rate for the graphic card.

How to connect

1. To get the best picture quality, adjust the PC graphics card to a 1024x768, 60Hz. Resolutions over UXGA cannot be displayed.
2. Use the monitor's RGB INPUT or DVI (Digital Visual Interface) INPUT port for video connections, depending on your PC connector.
If the graphic card on the PC does not output analog and digital RGB simultaneously, connect only one of either RGB INPUT or DVI INPUT to display the PC on the monitor.
If the graphic card on the PC does output analog and digital RGB simultaneously, set the monitor to either RGB or DVI; (the other mode is set to Plug and Play automatically by the monitor.)
3. Then, make the corresponding audio connections.
If using a sound card, adjust the PC sound as required.

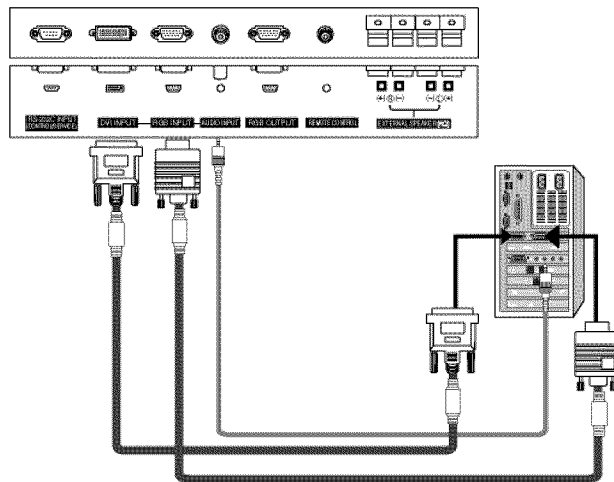

How to use

1. Turn on the PC and the monitor.
2. Turn on the display by pressing the POWER button on the monitor's remote control.
3. Use the **INPUT SELECT** button on the remote control to select **RGB** or **DVI**.
4. Check the image on your monitor. There may be noise associated with the resolution, vertical pattern, contrast or brightness in PC mode. If noise is present, change the PC mode to another resolution, change the refresh rate to another rate or adjust the brightness and contrast on the menu until the picture is clear. If the refresh rate of the PC graphic card can not be changed, change the PC graphic card or consult the manufacturer of the PC graphic card.

- NOTES:**
- Depending on the graphics card, DOS mode may not work if you use a DVI-I cable.
 - Avoid keeping a fixed image on the monitor's screen for a long period of time. The fixed image may become permanently imprinted on the screen. Use the Orbiter screen saver when possible.
 - The synchronization input form for Horizontal and Vertical frequencies is separate.

Monitor Display Specifications (RGB-PC / DVI-PC Mode)

Resolution	Horizontal Frequency(KHz)	Vertical Frequency(Hz)	Resolution	Horizontal Frequency(KHz)	Vertical Frequency(Hz)
640x350	31.468	70.09	852x480	31.500	60.00
	37.861	85.08		35.000	70.00
720x400	31.469	70.08	1024x768	37.500	75.00
	37.927	85.03		48.363	60.00
640x480	31.469	59.94	1152x864	56.476	70.06
	35.000	66.66		60.023	75.02
	37.861	72.80		54.348	60.05
	37.500	75.00	63.995	70.01	
800x600	43.269	85.00	1280x960	67.500	75.00
	35.156	56.25		60.000	60.00
	37.879	60.31	1280x1024	63.981	60.02
	46.875	75.00	1360x768	47.700	60.00
832x624	53.674	85.06	1366x768	59.625	75.02
	49.725	74.55		47.700	60.00
848x480	31.500	60.00		59.625	75.02
	35.000	70.00			
	37.500	75.00			

Operation

Turning on the Monitor

Turning on the Monitor just after installation

1. Connect power cord correctly.
2. Press the **⓪ ON/OFF** button on the Monitor. At this moment, the Monitor is switched to standby mode. Press the **INPUT SELECT** button on the Monitor or press the **POWER, INPUT SELECT** button on the remote control and then the Monitor will switch on.

Turning on the Monitor (power cord is still connected)

1. If the Monitor was turned off with the **⓪ ON/OFF** button on the Monitor
 - Press the **⓪ ON/OFF** button on the Monitor to turn the Monitor on.
2. If the Monitor was turned off with the remote control and then the **⓪ ON/OFF** button on the Monitor
 - Press the **⓪ ON/OFF** button on the Monitor and then press the **INPUT SELECT** button on the Monitor or press the **POWER, INPUT SELECT** button on the remote control to turn the Monitor on.

Menu Language Selection

- The menus can be shown on the screen in the selected language. First select your language.

1. Press the **MENU** button and then use **▲ / ▼** button to select the **SPECIAL** menu.
2. Press the **▶** button and then use **▲ / ▼** button to select **Language**.
3. Press the **▶** button and then use **▲ / ▼** button to select your desired language.
From this point on, the on-screen menus will be shown in the language of your choice.
4. Press the **OK** button to save.

Video Menu Options

- Picture menu adjustment are unique to each input source. Readjust Video menu settings for each following input source as preferred.
 - RGB (PC) / DVI (PC),
 - RGB (DTV) / DVI (DTV) / Component (480p, 720p, 1080i)
 - Video / S-Video / Component (480i)

APC (Auto Picture Control)

- APC adjusts the Monitor for the best picture appearance.
- When adjusting Video menu options (contrast, brightness, color, sharpness, and tint) manually, APC automatically changes the setting to **User**.

1. Press the **APC** button repeatedly to select the picture appearance setup option as shown below.



- You can also select **Clear**, **Optimum**, **Soft**, or **User** in the **VIDEO** menu.
- **Clear**, **Optimum**, and **Soft** settings are preset for optimum picture quality at the factory and cannot be changed.

Manual Picture Control (**User** option)

- You can adjust picture contrast, brightness, color, sharpness, and tint to the levels you prefer.
- PIP settings are not adjustable.

1. Press the **MENU** button and then use **▲ / ▼** button to select the VIDEO menu.
2. Press the **▶** button and then use **▲ / ▼** button to select the desired picture option (**Contrast**, **Brightness**, **Color**, **Sharpness**, or **Tint**).
3. Press the **▶** button and then use **◀ / ▶** button to make appropriate adjustments.
4. Press the **OK** button to save.

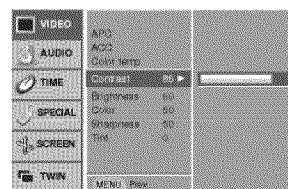

Auto Color Temperature Control

- To initialize values (reset to default settings), select the **Normal** option.
- When adjusting color temperature options (red, green, and blue) manually, ACC automatically changes the setting to **User**.

1. Press the **MENU** button and then use **▲ / ▼** button to select the VIDEO menu.
2. Press the **▶** button and then use **▲ / ▼** button to select **ACC**.
3. Press the **▶** button and then use **▲ / ▼** button to select either **Normal** (Default), **Cool** (Preset), **Warm** (Preset), or **User** (Manual Adjustment).
4. Press the **OK** button to save.

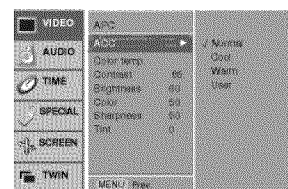

Manual Color Temperature Control (**User** option)

- You can adjust red, green, and blue to any color temperature you prefer.

1. Press the **MENU** button and then use **▲ / ▼** button to select the VIDEO menu.
2. Press the **▶** button and then use **▲ / ▼** button to select the **Color temp.** option.
3. Press the **▶** button and then use **▲ / ▼** button to select **Red**, **Green**, or **Blue**.
4. Use the **◀ / ▶** button to make appropriate adjustments.
 - The adjustment range for **Red**, **Green**, and **Blue** is -20 ~ +20.
5. Press the **OK** button to save.

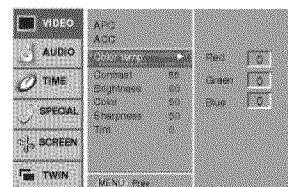

Audio Menu Options

DASP (Digital Auto Sound Processing)

- DASP lets you enjoy the best sound without any special adjustment because the Monitor selects the appropriate sound options based on the program content.
- When adjusting sound options (treble, and bass) manually, DASP automatically changes to **User**.

1. Press the **DASP** button repeatedly to select the appropriate sound setup as shown below.

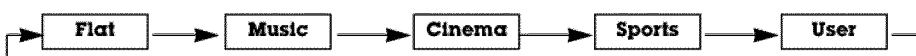

- You can also select **Flat**, **Music**, **Cinema**, **Sports**, or **User** in the **AUDIO** menu.
- **Flat**, **Music**, **Cinema**, and **Sports** are preset for good sound quality at the factory and cannot be changed.

Manual Sound Control (**User** option)

1. Press the **MENU** button and then use **▲** / **▼** button to select the **AUDIO** menu.
2. Press the **▶** button and then use **▲** / **▼** button to select the desired sound option (**Balance**, **Treble**, or **Bass**).
3. Press the **▶** button and then use **◀** / **▶** button to make appropriate adjustments.
4. Press the **OK** button to save.

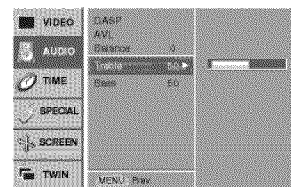

AVL (Auto Volume Leveler)

- This feature maintains an equal volume level; even if you change channels.

1. Press the **MENU** button and then use **▲** / **▼** button to select the **AUDIO** menu.
2. Press the **▶** button and then use **▲** / **▼** button to select **AVL**.
3. Press the **▶** button and then use **▲** / **▼** button to select **On** or **Off**.
4. Press the **OK** button to save.



Time Menu Options

Clock Setup

- If current time setting is wrong, reset the clock.
1. Press the **MENU** button and then use ▲ / ▼ button to select the TIME menu.
 2. Press the ► button and then use ▲ / ▼ button to select **Clock**.
 3. Press the ► button and then use ▲ / ▼ button to set the hour.
 4. Press the ► button and then use ▲ / ▼ button to set the minutes.
 5. Press the **OK** button to save.

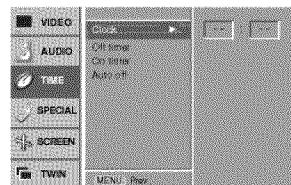

On/Off Timer Setup

- Timer function operates only if current time has been set.
 - Off-Timer function overrides On-Timer function if they are both set to the same time.
1. Press the **MENU** button and then use ▲ / ▼ button to select the TIME menu.
 2. Press the ► button and then use ▲ / ▼ button to select **Off timer** or **On timer**.
 3. Press the ► button and then use ▲ / ▼ button to select **On**.
 - To cancel **On/Off timer** function, select **Off**.
 4. Press the ► button and then use ▲ / ▼ button to set the hour.
 5. Press the ► button and then use ▲ / ▼ button to set the minutes.
 6. **For On timer function only**, press the ► button and then use ▲ / ▼ button to set the volume level at turn on.
 7. Press the **OK** button to save.

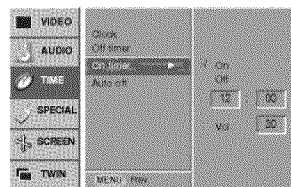

Auto Off

- If there is no input signal, the Monitor turns off automatically after 10 minutes.
1. Press the **MENU** button and then use ▲ / ▼ button to select the TIME menu.
 2. Press the ► button and then use ▲ / ▼ button to select **Auto off**.
 3. Press the ► button and then use ▲ / ▼ button to select **On** or **Off**.
 4. Press the **OK** button to save.

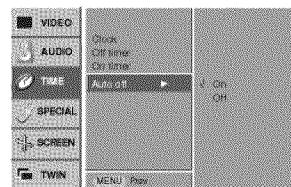

Sleep Timer

- The sleep timer turns the Monitor off at a preset time. Note that this setting is cleared when the monitor is turned off.
1. Press the **SLEEP** button repeatedly to select the number of minutes. First the **Min** option appears on the screen, followed by the following sleep timer options: 10, 20, 30, 60, 90, 120, 180, and 240 minutes.
 2. When the number of minutes you want is displayed on the screen, press the **OK** button. The timer begins to count down from the number of minutes selected.
 3. To check the remaining minutes before the monitor turns off, press the **SLEEP** or **OK** button once.
 4. To cancel the Sleep Timer, press the **SLEEP** button repeatedly until **Min** appears.

Special Menu Options

Key Lock

- The monitor can be set up so that it can only be used with the remote control.
- This feature can be used to prevent unauthorized viewing by disabling the front panel controls.
- This Monitor is programmed to remember which option it was last set to even if you turn the monitor off.

1. Press the **MENU** button and then use ▲ / ▼ button to select the **SPECIAL** menu.
2. Press the ► button and then use ▲ / ▼ button to select **Key lock**.
3. Press the ► button and then use ▲ / ▼ button to select **On** or **Off**.
 - When you select **On**, the display '▲ Key lock' appears on the screen if any button on the front panel is pressed.
4. Press the **OK** button to save.

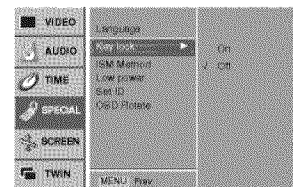

- When setting **Key lock 'On'**, if the monitor is turned off with the remote control, press the **POWER, INPUT SELECT** button on the monitor or **POWER** or **INPUT SELECT** on the remote control to turn the monitor on.

ISM (Image Sticking Minimization) Method

- A frozen still picture from a PC/video game displayed on the screen for prolonged periods of time will result in a ghost image remaining; even if you change the image. Avoid allowing a fixed image to remain on the Monitor's screen for a long period of time.

1. Press the **MENU** button and then use ▲ / ▼ button to select the **SPECIAL** menu.
2. Press the ► button and then use ▲ / ▼ button to select **ISM Method**.
3. Press the ► button and then use ▲ / ▼ button to select either **Normal**, **White wash**, **Orbiter**, or **Inversion**.

• Normal

If image sticking is never a problem, ISM is not necessary - set to Normal.

• White wash

White Wash removes permanent images from the screen. Note: An excessive burned in permanent image may be impossible to clear entirely with White Wash. To return to normal viewing, press any button.

• Orbiter

Orbiter may help prevent ghost images. However, it is best not to allow any fixed image to remain on the screen. To avoid a burning in a permanent image on the screen, the image will move every minute: Right → Right → Downside → Downside → Left → Left → Upside → Upside.

• Inversion

Inversion will automatically invert the plasma display panel color every 30 minutes.

4. Press the **OK** button to save.

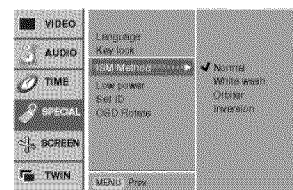

Low Power

- Low power reduces the plasma display's power consumption.

1. Press the **MENU** button and then use ▲ / ▼ button to select the **SPECIAL** menu.
2. Press the ► button and then use ▲ / ▼ button to select **Low power**.
3. Press the ► button and then use ▲ / ▼ button to select **On** or **Off**.

- When you select **On**, the screen darkens.

4. Press the **OK** button to save.

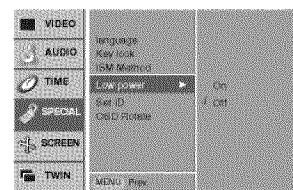

Menu Rotation for Vertical Viewing

1. Press the **MENU** button and then use the ▲ / ▼ button to select the **SPECIAL** menu.
2. Press the ► button and then use the ▲ / ▼ button to select **OSD Rotate**.
3. Press the ► button and then use the ▲ / ▼ button to select **Normal** or **Rotate**.

- Select **Normal**, if the monitor was installed horizontally.
- Select **Rotate**, if the monitor was installed vertically.

4. Press the **OK** button to save.

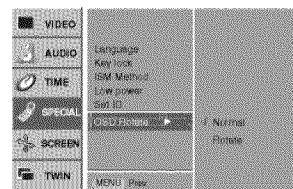

Screen Menu Options

Auto Adjustment

- RGB (PC) mode only; This function doesn't work for RGB-DTV mode.
- Automatically adjusts picture position and minimizes image shaking.
- After adjustment, if the image is still not correct, your Monitor is functioning properly but needs further adjustment.
- **Auto config.** and **Manual config.** are not available for DVI mode.

1. Press the **MENU** button and then use **▲** / **▼** button to select the **SCREEN** menu.
2. Press the **▶** button and then use **▲** / **▼** button to select **Auto config.**
3. Press the **▶** button to run Auto configure.
 - When **Auto config.** has finished, **OK** will appear on the screen.
 - If the position of the image is still not correct, try Auto adjustment again.
4. In RGB (PC) mode, if the image needs to be adjusted more after using **Auto config.**, you can make further adjustments with the **Manual config.** option.



Setting Picture Format

- Caution: If a 4:3 fixed image is shown with gray bars at the sides of the screen for a long time, the gray images may remain visible.
 - All aspect ratio for RGB 480p, DVI 480p, Component 480i/480p, Video, and S-Video sources are shown below.
 - Use 4:3, or 16:9 for other input sources.
1. Press the **ARC** button repeatedly to select the desired picture format. You can also adjust **ARC** in the **SCREEN** menu.
 - **4:3**
 - Choose **4:3** when you want to view a picture with an original 4:3 aspect ratio, with gray bars appearing at both the left and right sides to fill the screen.
 - **16:9**
 - Choose **16:9** when you want to adjust the picture horizontally, in a linear proportion to fill the entire screen.
 - **Horizon**
 - Choose **Horizon** when you want to adjust the picture in a non-linear proportion, that is, more enlarged at both sides, to create a spectacular view.
 - **Zoom**
 - Choose **Zoom** when you want to view the picture without any alteration. However, the top and bottom portions of the picture will be cropped.

Picture Size Zoom

- If enlarging or reducing the picture, the image may become distorted.
1. Use **ZOOM+**/**ZOOM-** button to enlarge or reduce the picture size.
 - Zoom adjustment range is 100~300.
 2. Adjust the main picture position using the **▲** / **▼** / **◀** / **▶** buttons while in enlarged picture mode.

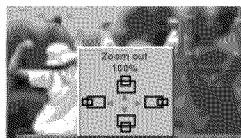

Split Zoom

- Enlarges the picture in correct proportions.
- Split Zoom can be used for all input sources.
- In 2-Split Zoom mode, you can only move the image up or down.
- If a screen is enlarged, a screen can move without selecting section of screen Split Zoom.
- It's not available to use this function if **OSD Rotate** is set to the **Rotate** option.

1. Press the **SPLIT ZOOM** button repeatedly to select either 2, 4, or 9 Split Zoom.

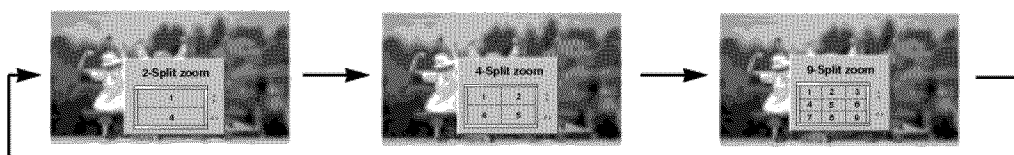

2. Press the number button corresponding to the section you wish to enlarge. You can move within the enlarged image with the **▲ / ▼ / ◀ / ▶** button. To return to normal viewing, press the **SPLIT ZOOM** button again.

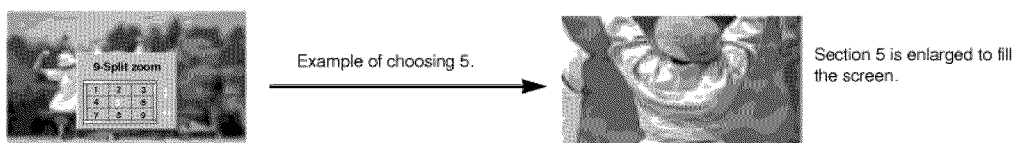

Screen Position

- This function works in the following mode:
RGB-PC, RGB-DTV (480p,720p,1080i), COMPONENT (480p,720p,1080i).

1. Press the **MENU** button and then use **▲ / ▼** button to select the **SCREEN** menu.
2. Press the **▶** button and then use **▲ / ▼** button to select **Position**.
3. Press the **▶** button and then use **▲ / ▼ / ◀ / ▶** button to adjust the position.
4. Press the **OK** button to save.

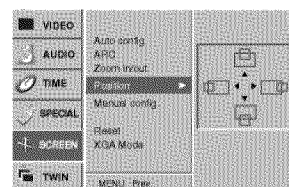

Manual Configure (RGB-PC mode only)

- If the image still isn't clear after auto adjustment and especially if characters are still jittery, adjust the picture **Phase** manually.
- To correct the screen size, adjust **Clock**.

1. Press the **MENU** button and then use **▲ / ▼** button to select the **SCREEN** menu.
2. Press the **▶** button and then use **▲ / ▼** button to select **Manual config**.
3. Press the **▶** button and then use **▲ / ▼** button to select **Phase** or **Clock**.
4. Use the **◀ / ▶** button to make appropriate adjustments.

- The **Phase** adjustment range is 0 ~ 31.
- The **Clock** adjustment range is -50 ~ +50.

5. Press the **OK** button to save.

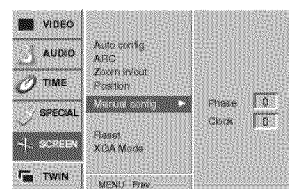

Screen Menu Options continued

Screen Adjustments (Video, S-Video, and Component 480i mode only)

- Use this function to correct jittering or picture instability during video tape playback.
 1. Press the **MENU** button and then use **▲ / ▼** button to select the **SCREEN** menu.
 2. Press the **▶** button and then use **▲ / ▼** button to select **Screen adj.**
 3. Press the **▶** button and then use **▲ / ▼** button to select **TV** or **VCR**.
 - Select the **VCR** option if watching a VCR.
 - Select the **TV** option for other equipment.(Except VCR)
 4. Press the **OK** button to save.

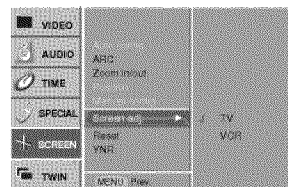

Initializing (Reset to original factory value)

- You can reset values in all modes.
- To initialize the adjusted value, follow instructions below.
 1. Press the **MENU** button and then use **▲ / ▼** button to select the **SCREEN** menu.
 2. Press the **▶** button and then use **▲ / ▼** button to select **Reset**.
 3. Press the **▶** button.
 - You can initialize Zoom In/Out, Manual config., Position, Split zoom, PIP size, PIP position, and sub picture size for twin picture features.

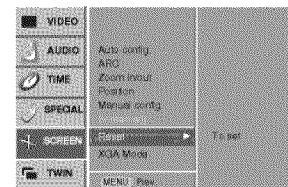

Selecting Wide VGA/XGA mode (RGB-PC, DVI-PC mode only)

- To see a normal picture, match the resolution of RGB XGA mode (1024x768, 1360x768, 1366x768) with the selection for XGA mode and the resolution of RGB VGA mode (640x480, 848x480, 852x480) with the selection for VGA mode in the SCREEN menu.
- If the input source is RGB VGA mode, the screen menu option is changed from **XGA mode** to **VGA mode** automatically.

1. Press the **MENU** button and then use **▲ / ▼** button to select the **SCREEN** menu.
2. Press the **▶** button and then use **▲ / ▼** button to select **VGA mode/XGA mode**.
3. Press the **▶** button and then use **▲ / ▼** button to select the desired VGA/XGA resolution.
4. Press the **OK** button to save.

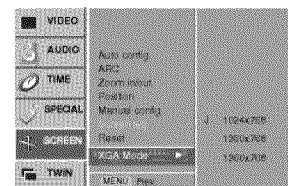

Luminance Noise Reduction (Video, S-Video and Component 480i modes only)

- Use YNR to reduce the picture noise which may appear on the screen.
 1. Press the **MENU** button and then use **▲ / ▼** button to select the **SCREEN** menu.
 2. Press the **▶** button and then use **▲ / ▼** button to select **YNR**.
 3. Press the **▶** button and then use **▲ / ▼** button to select **On** or **Off**.
 4. Press the **OK** button to save.

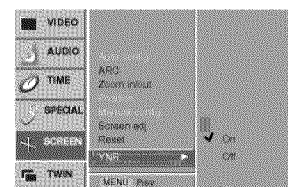

PIP (Picture-In-Picture) Feature

- PIP lets you view 2 different inputs (sources) on your monitor screen at the same time. One source will be large, and the other source will show a smaller inset image.

Watching PIP

Press the **PIP** button repeatedly to turn PIP on or off.



PIP Size

Press the **WIN.SIZE** button and then use **◀ / ▶** button to change the sub picture size.



PIP Aspect Ratio

Press the **PIP ARC** button. The sub picture appears as shown.

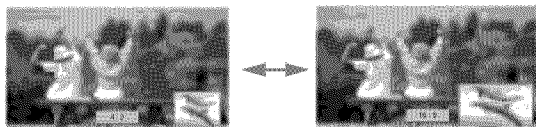

Swapping PIP

Press the **SWAP** button to switch the main and sub pictures.

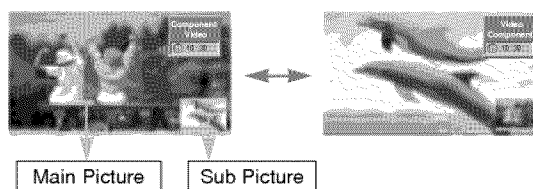

Moving PIP

Press the **WIN.POSITION** button.

Press the **▲ / ▼ / ◀ / ▶** button repeatedly until desired position is achieved. The sub picture moves up/down/left/right.



Selecting an Input Signal Source for the PIP

Use the **SUB INPUT** button to select the input source for the sub picture.

Main Picture Source	Available Sub Picture Sources
Video	S-Video, Component 480i/480p/720p/1080i, RGB, and DVI
S-Video	Video, Component 480i/480p/720p/1080i, RGB, and DVI
Component 480i	Video, S-Video, RGB, and DVI
Component 480p/720p/1080i	Video and S-Video
RGB and DVI	Component 480i, Video, and S-Video

Twin Picture Setup Option

- As the name suggests, this mode splits the screen into 2, allowing 2 picture sources to be shown on the monitor screen at the same time. Each source is given half the screen.

Watching Twin Picture

Press the **TWIN PICTURE** button repeatedly to select one of the Twin Picture options.

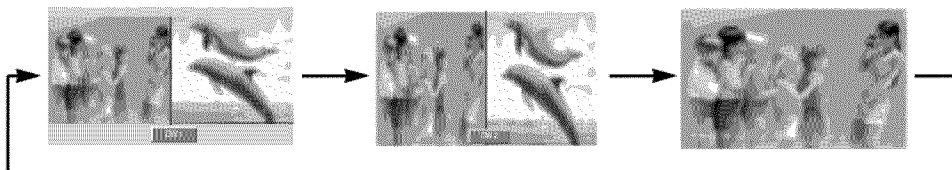

Sub Picture Size Adjustment

Press the **WIN.SIZE** button.

- Use the ◀ / ▶ button to change the sub picture size.
- Using the WIN.SIZE function in Twin Picture mode, main and sub picture sizes are changed simultaneously.
- Using the WIN.SIZE function in PIP mode, sub picture size is changed.
- WIN.POSITION is not functional in Twin Picture mode.



Swapping the Twin Picture

Use the **SWAP** button to switch the main and sub pictures in twin picture mode.

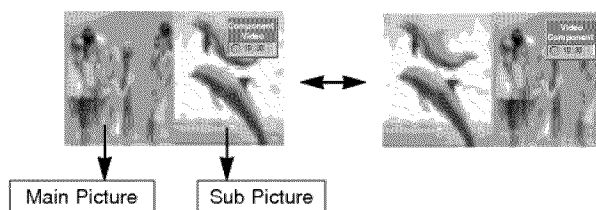

Selecting a Source for the Twin Picture

Use the **SUB INPUT** button to select the input source for the sub picture.

Main Picture Source	Available Sub Picture Sources
Video	S-Video, Component 480i/480p/720p/1080i, RGB, and DVI
S-Video	Video, Component 480i/480p/720p/1080i, RGB, and DVI
Component 480i	Video, S-Video, RGB, and DVI
Component 480p/720p/1080i	Video and S-Video
RGB and DVI	Component 480i, Video, and S-Video

External Control Device Setup

- Connect the RS-232C input jack to an external control device (such as a computer or an A/V control system) and control the Monitor's functions externally.
- Connect the serial port of the control device to the RS-232C jack on the Monitor back panel.
- RS-232C connection cables are not supplied with the Monitor.

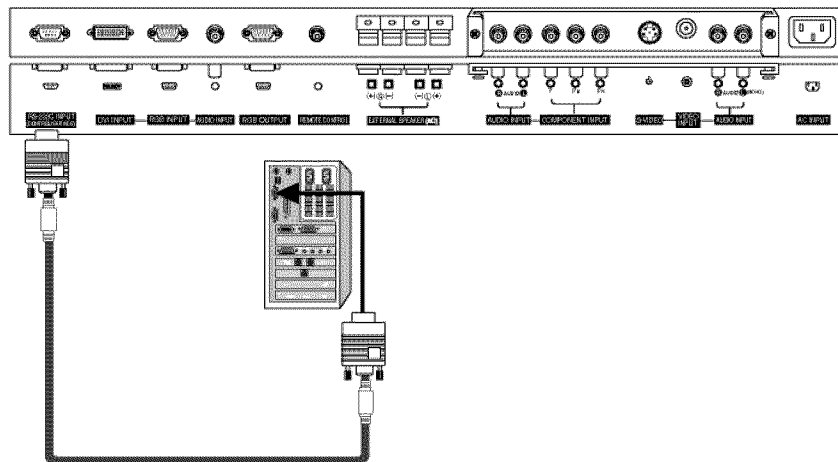

Type of Connector: D-Sub 9-pin Male

No.	Pin Name
1	No Connection
2	RXD (Receive data)
3	TXD (Transmit data)
4	DTR (DTE side ready)
5	GND
6	DSR (DCE side ready)
7	RTS (Ready to send)
8	CTS (Clear to send)
9	No Connection

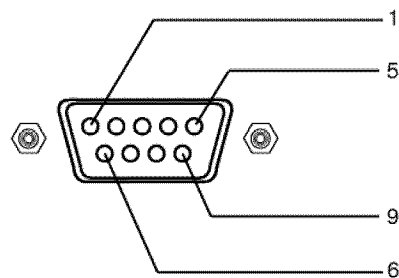

RS-232C Configurations

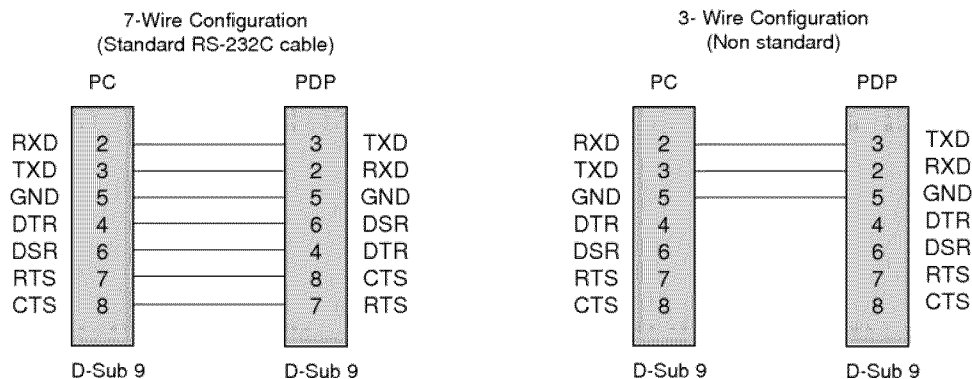

Set ID

- Use this function to specify a monitor ID number.
 - Refer to 'Real Data Mapping 1'. See page 27.
1. Press the **MENU** button and then use the **▲ / ▼** button to select the **SPECIAL** menu.
 2. Press the **▶** button and then use **▲ / ▼** button to select **Set ID**.
 3. Press the **▶** button and then use **◀ / ▶** button to adjust **Set ID** to choose the desired monitor ID number.
 - The adjustment range of **Set ID** is 1 ~ 99.



Communication Parameters

- Baud rate : 115200 bps (UART)
- Data length : 8 bits
- Parity : None
- Stop bit : 1 bit
- Communication code : ASCII code

Command Reference List

	COMMAND 1	COMMAND 2	DATA (Hexadecimal)
01. Power	k	a	0 ~ 1
02. Input Select	k	b	0 ~ 4
03. Aspect Ratio	k	c	0 ~ 3
04. Screen Mute	k	d	0 ~ 1
05. Volume Mute	k	e	0 ~ 1
06. Volume Control	k	f	0 ~ 64
07. Contrast	k	g	0 ~ 64
08. Brightness	k	h	0 ~ 64
09. Color	k	i	0 ~ 64
10. Tint	k	j	0 ~ 64
11. Sharpness	k	k	0 ~ 64
12. OSD Select	k	l	0 ~ 1
13. Remote Control Lock Mode	k	m	0 ~ 1
14. PIP/Twin	k	n	0 ~ 3
15. PIP Aspect Ratio	k	o	0 ~ 1
16. Split Zoom	k	p	0 ~ 99
17. PIP Position	k	q	0 ~ 3
18. Treble	k	r	0 ~ 64
19. Bass	k	s	0 ~ 64
20. Balance	k	t	0 ~ 64
21. Color Temperature	k	u	0 ~ 3
22. Red Adjustment	k	v	0 ~ C8
23. Green Adjustment	k	w	0 ~ C8
24. Blue Adjustment	k	\$	0 ~ C8
25. PIP Input Source	k	y	0 ~ 4
26. Abnormal State	k	z	0 ~ a
27. ISM Method	j	p	0 ~ 3
28. Low Power	j	q	0 ~ 1
29. Orbiter Time Setting	j	r	1 ~ FE
30. Orbiter Pixel Setting	j	s	0 ~ 9
31. Picture Size Setting for Twin Picture mode	j	t	0 ~ 64
32. Auto Configure	j	u	1

- Menu doesn't display on screen when setting the 4, 12, 13, and 26 ~ 32.

Transmission / Receiving Protocol

Transmission

[Command1][Command2][][Set ID][][Data][Cr]

- * [Command 1]: k, j
- * [Command 2]: To control PDP set.
- * [Set ID]: You can adjust the set ID to choose desired monitor ID number in Special menu. Adjustment range is 1 ~ 99. When selecting Set ID '0', every connected PDP set is controlled. Set ID is indicated as decimal (1~99) on menu and as Hexa decimal (0x0~0x63) on transmission/receiving protocol.
- * [DATA]: To transmit command data.
Transmit 'FF' data to read status of command.
- * [Cr]: Carriage Return
ASCII code '0x0D'
- * []: ASCII code 'space (0x20)'

OK Acknowledgement

[Command2][][Set ID][][OK][Data][x]

- * The Monitor transmits ACK (acknowledgement) based on this format when receiving normal data. At this time, if the data is data read mode, it indicates present status data. If the data is data write mode, it returns the data of the PC computer.

Error Acknowledgement

[Command2][][Set ID][][NG][x]

- * The Monitor transmits ACK (acknowledgement) based on this format when receiving abnormal data from non-viable functions or communication errors.

- Data
- 1: Illegal Code
 - 2: Not supported function
 - 3: Wait more time

08. Brightness (Command2:h)

- ▶ To adjust screen brightness.
You can also adjust brightness in the Video menu.

Transmission

[k][h][][Set ID][][Data][Cr]

Data Min : 0 ~ Max : 64

- Refer to 'Real Data Mapping 1'. See page 27.

Acknowledgement

[h][][Set ID][][OK][Data][x]

09. Color (Command2:i)

- ▶ To adjust the screen color.
You can also adjust color in the Video menu.

Transmission

[k][i][][Set ID][][Data][Cr]

Data Min : 0 ~ Max : 64

- Refer to 'Real Data Mapping 1'. See page 27.

Acknowledgement

[i][][Set ID][][OK][Data][x]

10. Tint (Command2:j)

- ▶ To adjust the screen tint.
You can also adjust tint in the Video menu.

Transmission

[k][j][][Set ID][][Data][Cr]

Data Red : 0 ~ Green : 64

- Refer to 'Real Data Mapping 1'. See page 27.

Acknowledgement

[j][][Set ID][][OK][Data][x]

11. Sharpness (Command2:k)

- ▶ To adjust the screen sharpness.
You can also adjust sharpness in the Video menu.

Transmission

[k][k][][Set ID][][Data][Cr]

Data Min: 0 ~ Max: 64

- Refer to 'Real Data Mapping 1'. See page 27.

Acknowledgement

[k][][Set ID][][OK][Data][x]

12. OSD Select (Command2:l)

- ▶ To select OSD (On Screen Display) on/off.

Transmission

[k][l][][Set ID][][Data][Cr]

Data 0: OSD off 1: OSD on

Acknowledgement

[l][][Set ID][][OK][Data][x]

13. Remote Control Lock Mode (Command2:m)

- ▶ To lock the remote control and front panel controls on the monitor

Transmission

[k][m][][Set ID][][Data][Cr]

Data 0: Lock off 1: Lock on

Acknowledgement

[m][][Set ID][][OK][Data][x]

- If you're not using the remote control and front panel controls on the monitor, use this mode. When main power is turned on/off, remote control lock is released.

14. PIP / Twin (Command2:n)

- ▶ To control the PIP (Picture-in-Picture) or Twin Picture.
You can also control the PIP/TWIN using the PIP or Twin PICTURE button on the remote control or in the Special menu.

Transmission

[k][n][][Set ID][][Data][Cr]

Data 0: PIP/DW off 2: DW1
1: PIP 3: DW2

Acknowledgement

[n][][Set ID][][OK][Data][x]

15. PIP Aspect Ratio (Command2:o)

- ▶ To select the PIP picture format.
You can also select the PIP picture format using PIP ARC on the remote control.

Transmission

[k][o][][Set ID][][Data][Cr]

Data 0: 4:3 1: 16:9

Acknowledgement

[o][][Set ID][][OK][Data][x]

16. Split Zoom (Command2:p)

- ▶ To operate split zoom function and select the split zoom section number.

Transmission

[k][p][][Set ID][][Data][Cr]

Data Min: 0 ~ Max: 99

- Refer to 'Real Data Mapping 2' below.

Acknowledgement

[p][][Set ID][][OK][Data][x]

* **Real Data Mapping 2**

- 0 : Reset split zoom
- 21: Selection 1 of 2 split zoom
- 24: Selection 4 of 2 split zoom
- 41: Selection 1 of 4 split zoom
- 42: Selection 2 of 4 split zoom
- 44: Selection 4 of 4 split zoom
- 45: Selection 5 of 4 split zoom
- 91: Selection 1 of 9 split zoom
- ⋮
- 99: Selection 9 of 9 split zoom

17. PIP Position (Command2:q)

- ▶ To select sub picture position for PIP.
You can also adjust the sub picture position using Win.position on the remote control or in the Special menu.

Transmission

[k][q][][Set ID][][Data][Cr]

Data 0: Right down on screen
1: Left down on screen
2: Left up on screen
3: Right up on screen

Acknowledgement

[q][][Set ID][][OK][Data][x]

18. Treble (Command2:r)

- ▶ To adjust treble.
You can also adjust treble in the Audio menu.

Transmission

[k][r][][Set ID][][Data][Cr]

Data Min: 0 ~ Max: 64

- Refer to 'Real Data Mapping 1'. See page 27.

Acknowledgement

[r][][Set ID][][OK][Data][x]

19. Bass (Command2:s)

- ▶ To adjust bass.
You can also adjust bass in the Audio menu.

Transmission

[k][s][][Set ID][][Data][Cr]

Data Min: 0 ~ Max: 64

- Refer to 'Real Data Mapping 1'. See page 27.

Acknowledgement

[s][][Set ID][][OK][Data][x]

20. Balance (Command2:t)

- ▶ To adjust balance.
You can also adjust balance in the Audio menu.

Transmission

[k][t][][Set ID][][Data][Cr]

Data Min: 0 ~ Max: 64

- Refer to 'Real Data Mapping 1'. See page 27.

Acknowledgement

[t][][Set ID][][OK][Data][x]

21. Color Temperature (Command2:u)

- ▶ To adjust color temperature.
You can also adjust ACC in the Video menu.

Transmission

[k][u][][Set ID][][Data][Cr]

Data 0: Normal 1: Cool 2: Warm 3: User

Acknowledgement

[u][][Set ID][][OK][Data][x]

22. Red Adjustment (Command2:v)

- ▶ To adjust red in color temperature.

Transmission

[k][v][][Set ID][][Data][Cr]

Data Min: 0 ~ Max: C8

- Refer to 'Real Data Mapping 3' as shown below.

Acknowledgement

[v][][Set ID][][OK][Data][x]

23. Green Adjustment (Command2:w)

- ▶ To adjust green in color temperature.

Transmission

[k][w][][Set ID][][Data][Cr]

Data Min: 0 ~ Max: C8

- Refer to 'Real Data Mapping 3' as shown below.

Acknowledgement

[w][][Set ID][][OK][Data][x]

24. Blue Adjustment (Command2:\$)

- ▶ To adjust blue in color temperature.

Transmission

[k][\$][][Set ID][][Data][Cr]

Data Min: 0 ~ Max: C8

- Refer to 'Real data mapping 3' as shown below.

Acknowledgement

[\$][][Set ID][][OK][Data][x]

*** Real Data Mapping 3**

0 : -20
5 : -19
A : -18
⋮
5F: -1
64: 0
69: +1
⋮
C3: +19
C8: +20

25. PIP Input Select (Command2:y)

- ▶ To select input source for sub picture in PIP mode.

Transmission

[k][y][][Set ID][][Data][Cr]

Data 0: RGB 1: Component
 2: Video 3: S-video 4: DVI

Acknowledgement

[y][][Set ID][][OK][Data][x]

26. Abnormal State (Command2:z)

- ▶ To recognize an abnormal state.

Transmission

[k][z][][Set ID][][FF][Cr]

Data FF:Read

Acknowledgement

[z][][Set ID][][OK][Data][x]

Data 0: Normal (Power on and signal exist)
 1: No signal (Power on).
 2: Turn the monitor off with remote control.
 3: Turn the monitor off with Sleep Time function.
 4: Turn the monitor off with RS-232C function.
 5: 5V down.
 6: AC down.
 7: Turn the monitor off with Fan Alarm function.
 8: Turn the monitor off with Off Time function.
 9: Turn the monitor off with Auto Off function.
 a: Turn the monitor off with AV board detect.

27. ISM Method (Command2:p)

- ▶ To avoid having a fixed image remain on screen.

Transmission

[j][p][][Set ID][][Data][Cr]

Data 0: Normal 2: Orbiter
 1: White wash 3: Inversion

Acknowledgement

[p][][Set ID][][OK][Data][x]

28. Low Power (Command2:q)

- ▶ To control the low power function on/off.

Transmission

[j][q][][Set ID][][Data][Cr]

Data 0: Low power off
 1: Low power on

Acknowledgement

[q][][Set ID][][OK][Data][x]

29. Orbiter Time Setting (Command2:r)

- ▶ To adjust orbiter operation time term.

Transmission

[j][r][][Set ID][][Data][Cr]

Data Min: 1 ~ Max: FE

Acknowledgement

[r][][Set ID][][OK][Data][x]

30. Orbiter Pixel Setting (Command2:s)

- ▶ To adjust pixel number in orbiter function.

Transmission

[j][s][][Set ID][][Data][Cr]

Data Min: 0 ~ Max: 9

Acknowledgement

[s][][Set ID][][OK][Data][x]

31. Picture Size Setting for Twin Picture mode (Command2:t)

- ▶ To adjust main picture size in twin picture mode.

Transmission

[j][t][][Set ID][][Data][Cr]

Data Min: 0 ~ Max: 64

- Refer to 'Real Data Mapping1'. See page 27.

Acknowledgement

[t][][Set ID][][OK][Data][x]

32. Auto Configure (Command2:u)

- ▶ To adjust picture position and minimize image shaking automatically. Auto Configure only works in RGB-PC mode.

Transmission

[j][u][][Set ID][][Data][Cr]

Data 1: To set

Acknowledgement

[u][][Set ID][][OK][Data][x]

IR Code Information

How to Connect

- ▶ Connect your wired remote control to the Remote Control port on the Monitor.

Remote Control IR Code

▶ Output waveform

Single pulse, modulated with 37.917KHz signal at 455KHz

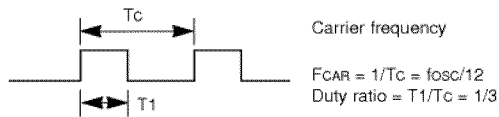

▶ Configuration of frame

- 1st frame

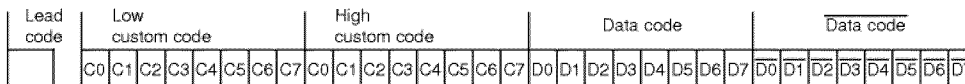

- Repeat frame

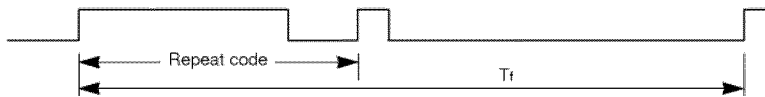

▶ Lead code



▶ Repeat code

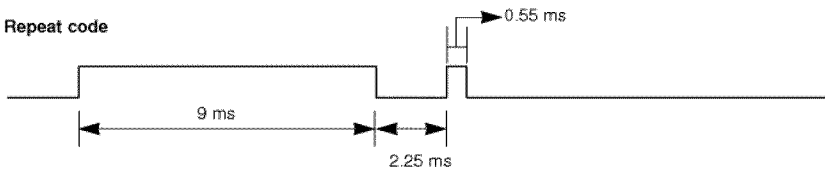

▶ Bit description



▶ Frame interval : Tf

The waveform is transmitted as long as a key is depressed.

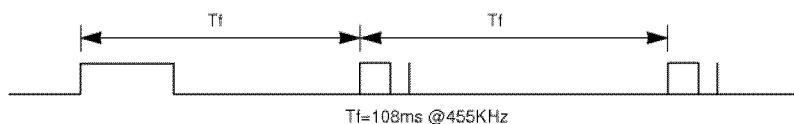



Code (Hexa)	Function	Note
00H	UP (▲)	R/C Button
01H	DOWN (▼)	R/C Button
02H	VOL+ (▶)	R/C Button
03H	VOL- (◀)	R/C Button
08H	POWER On/Off	R/C Button (Power On/Off)
C4H	POWER ON	Discrete IR Code (Only Power On)
C5H	POWER OFF	Discrete IR Code (Only Power Off)
09H	MUTE	R/C Button
10H	Number Key 0	R/C Button
11H	Number Key 1	R/C Button
12H	Number Key 2	R/C Button
13H	Number Key 3	R/C Button
14H	Number Key 4	R/C Button
15H	Number Key 5	R/C Button
16H	Number Key 6	R/C Button
17H	Number Key 7	R/C Button
18H	Number Key 8	R/C Button
19H	Number Key 9	R/C Button
0BH	All INPUT SELECT	R/C Button (RGB/DVI/V-deo/S-video/Component)
D5H	RGB	Discrete IR Code (Input RGB Selection)
C6H	DVI	Discrete IR Code (Input DVI Selection)
5AH	VIDEO	Discrete IR Code (Input Video Selection)
D8H	S-VIDEO	Discrete IR Code (Input S-video Selection)
BFH	COMPONENT	Discrete IR Code (Input Component Selection)
0EH	SLEEP	R/C Button
44H	OK (■)	R/C Button
43H	MENU	R/C Button
52H	DASP	R/C Button
4DH	APC	R/C Button
60H	PIP	R/C Button
61H	PIP INPUT	R/C Button
63H	SWAP	R/C Button (PIP/TWIN Exchange)
64H	PIP ARC	R/C Button (4:3/16:9)
6BH	TWIN PICTURE	R/C Button
40H	ZOOM +	R/C Button
41H	ZOOM -	R/C Button
69H	Window Size	R/C Button
6AH	Window Position	R/C Button
7BH	Split Zoom	R/C Button
79H	ARC	R/C Button(4:3/16:9/Zoom Mode Selection)
76H	ARC (4:3)	Discrete IR Code (Only 4:3 mode)
77H	ARC (16:9)	Discrete IR Code (Only 16:9 mode)
AFH	ARC (ZOOM)	Discrete IR Code (Only ZOOM mode)
99H	Auto configure	Discrete IR Code (Only RGB-PC mode)

Troubleshooting Checklist

No picture & No sound

- Check whether the Monitor is turned on.
- Is power cord inserted into wall power outlet?
- Test the wall power outlet, plug other product's power cord into the power outlet where the Monitor's power cord was plugged in.

Picture OK & No sound

- Press the **VOLUME** (▶) button.
- Sound muted? Press **MUTE** button.

The remote control doesn't work

- Check to see if there is any object between the Plasma Display and the remote control causing obstruction.
- Are batteries installed with correct polarity (+ to +, - to -)? (Refer to p.8)
- Install new batteries. (Refer to p.8)

Picture appears slowly after switching on

- This is normal, the image is muted during the plasma display startup process. Please contact your service center, if the picture has not appeared after five minutes.

No or Poor color or Poor picture

- Select **Color** in the **VIDEO** menu and press the **VOLUME** (▶) button. (Refer to p.16)
- Keep a sufficient distance between the Monitor and the VCR.
- Activate any function to restore the brightness of the picture. (If still picture is on the screen for more than 5 minutes, the screen gets dark.)

Horizontal/vertical bars or picture shaking

- Check for local interference such as an electrical appliance or power tool.

No output from one of the speakers

- Adjust **Balance** in the **AUDIO** menu. (Refer to p.17)

Unusual sound from inside the monitor

- A change in ambient humidity or temperature may result in an unusual noise when the plasma display is turned on or off and does not indicate a fault with the monitor.

Maintenance

- Early malfunctions can be prevented. Careful and regular cleaning can extend the amount of time you will have your new Monitor. Be sure to turn the power off and unplug the power cord before you begin any cleaning.

Cleaning the Screen

1. Here's a great way to keep the dust off your screen for a while. Wet a soft cloth in a mixture of lukewarm water and a little fabric softener or dish washing detergent. Wring the cloth until it's almost dry, and then use it to wipe the screen.
2. Make sure the excess water is off the screen, and then let it air-dry before you turn on your Monitor.

Cleaning the Cabinet

To remove dirt or dust, wipe the cabinet with a soft, dry, lint-free cloth. Please be sure not to use a wet cloth.

Extended Absence



If you expect to leave your Monitor dormant for a long time (such as a vacation), it's a good idea to unplug the power cord to protect against possible damage from lightning or power surges.

Product Specifications

MODELS	P60W38, P60W38H
Width (inches / mm)	57.3 / 1455
Height (inches / mm)	84.3 / 883
Depth (inches / mm)	3.9 / 99
Weight (pounds / kg)	144 / 65.3
Power requirement	AC120V, 60Hz
Resolution	1366 x 768 (Dot)
Color	16,770,000 (256 steps of each R, G and B)
Operating Temperature Range	32 ~ 104°F (0 ~ 40°C)
Operating Humidity Range	Less than 80%
Maximum Elevation	6561 feet (2000m)

- The specifications shown above may be changed without notice for quality improvement.

**ZENITH ELECTRONICS CORPORATION
PLASMA DISPLAY PANEL P60W38/H LIMITED WARRANTY – USA**

Zenith will repair or replace your product, at Zenith's option, if it proves to be defective in material or workmanship under normal use, during the warranty period ("Warranty Period") listed below, effective from the date of original consumer/end user purchase. This warranty is good only to the original consumer/end user of the product and is effective only when used in the United States.

<p><u>WARRANTY PERIOD:</u></p> <p>LABOR: ONE YEAR from the Date of Purchase.</p> <p>PARTS: ONE YEAR from the Date of Purchase.</p> <p>Effective Date of Warranty: Your warranty period Begins on the date of sale to the original consumer/end user. KEEP THE DEALER'S DATED BILL OF SALE OR PROOF OF DELIVERY as evidence of the purchase date. You will be required to submit a legible copy of your bill of sale or proof of delivery when requesting warranty service.</p> <p>Repair Parts and Replacement Units are warranted for the remaining period of the original warranty.</p>	<p><u>HOW SERVICE IS HANDLED:</u></p> <p>In Home Service. Please Call the Zenith Interactive Center at 1-877-9ZENITH (1-877-993-6484) to schedule a service appointment.</p> <p>Your unit will be repaired or replaced with a new, substitute model or factory reconditioned unit, at Zenith's option. If repaired, parts used in the repair may be new or remanufactured.</p> <p>Visit our website at http://www.zenithservice.com</p>
--	--

THIS WARRANTY IS IN LIEU OF ANY OTHER WARRANTIES, EXPRESS OR IMPLIED, INCLUDING WITHOUT LIMITATION, ANY WARRANTY OF MERCHANTABILITY OR FITNESS FOR A PARTICULAR PURPOSE. TO THE EXTENT ANY IMPLIED WARRANTY IS REQUIRED BY LAW, IT IS LIMITED IN DURATION TO THE EXPRESS WARRANTY PERIOD ABOVE. ZENITH WILL NOT BE LIABLE FOR ANY INCIDENTAL, CONSEQUENTIAL, INDIRECT, SPECIAL, OR PUNITIVE DAMAGES OF ANY NATURE, INCLUDING, WITHOUT LIMITATION, LOST PROFITS, LOST OR CORRUPTED PROGRAMMING OR DATA, OR ANY OTHER DAMAGE WHETHER BASED IN CONTRACT, TORT, OR OTHERWISE. Some states do not allow the exclusion or limitation of incidental or consequential damages or limitations on how long an implied warranty lasts, so the above exclusion or limitation may not apply to you. This warranty gives you specific legal rights and you may also have other rights that vary from state to state.

THIS LIMITED WARRANTY DOES NOT APPLY TO:

<ul style="list-style-type: none"> ● damage caused in shipping or transit ● service required as a result of improper installation, including incorrect or insufficient AC supply (please consult the owner's manual for power supply requirements) ● installation or repair of antenna systems, cable converters, cable company supplied equipment, or other components in a video system ● set-up or adjustment on consumer controls, or damage caused by improper adjustments ● damage caused by other system components ● any panel that has been modified or incorporated into any other product ● replacement of batteries on the remote control. ● damage (including cosmetic damage), failure, loss 	<p>or personal injury due to misuse, abuse, negligence, improper maintenance or storage, or to acts of nature or other causes beyond Zenith's control. (Causes beyond Zenith's control include but are not limited to lightning strike, power surges, power outages and water damage.)</p> <ul style="list-style-type: none"> ● Image burn-in ● repair or replacement of warranted parts by other than Zenith Authorized Service Centers. ● units purchased or serviced outside of the U.S.A. ● product where the original factory serial numbers have been removed, defaced or changed in any way. ● product sold and labeled as "as is, where is" or similar disclaimer.
--	---

The costs of repair or replacement under these excluded circumstances shall be borne by the consumer.

CONCERNING PIXEL FUNCTIONALITY: Your Plasma Display Panel contains about one million individual pixels. Plasma displays typically contain a small number of pixels that do not function normally. Your display has been inspected and is in compliance with manufacturer's specifications, indicating that any pixel defects do not affect the operation or use of your display.

CUSTOMER INTER-ACTIVE CENTER NUMBERS:

<p>To obtain customer assistance, product information, or Dealer or Service locations</p>	<p>Call 1-877-9Zenith (1-877-993-6484) (24 hours a day, 365 days per year) and select appropriate options from the menu. Or visit our website at http://www.zenithservice.com</p>
--	--

BEFORE CALLING FOR SERVICE:

- Please check your operating guide – you may avoid a service call.
- Please have your product model number, serial number and the date of purchase or the date of original installation available.
- If a replacement unit is required, under some circumstances you may be asked to provide a reserve deposit to Zenith against a credit card number as surety for advanced shipment. Your credit card will not be charged if you return the defective unit within 10 working days.
- If a replacement unit is received, please use the carton and packaging from that unit in returning the defective unit to Zenith.
- Parts and service in accordance with the Zenith warranty are Zenith's responsibility and will be provided without charge. Other service requirements will be at the owner's expense. If you have problems in obtaining satisfactory warranty service, write or call the Zenith Customer Interactive Center. Service may be provided by independently owned and operated service organizations.
- To assure proper credit and avoid unnecessary charges, you must obtain a Return Authorization before returning any product for Zenith Warranty Service. Contact the number below or your authorized Zenith repair facility for details.

IMPORTANT: Please fill out and mail your Product Registration Card or go to www.zenithservice.com to register your product online. This information allows Zenith to reach you promptly should we discover a safety or reliability problem that could affect you.

TO CONTACT ZENITH BY MAIL:

Zenith Customer Interactive Center
P.O. Box 240007
201 James Record Road
Huntsville, AL 35824
ATTN: CIC Plasma Display, Building 3