

Sears

owners manual

MODEL NO.
161.210400

Caution:
Read Rules For
Safe Operation
and Complete
Operating Test
Procedures
Carefully

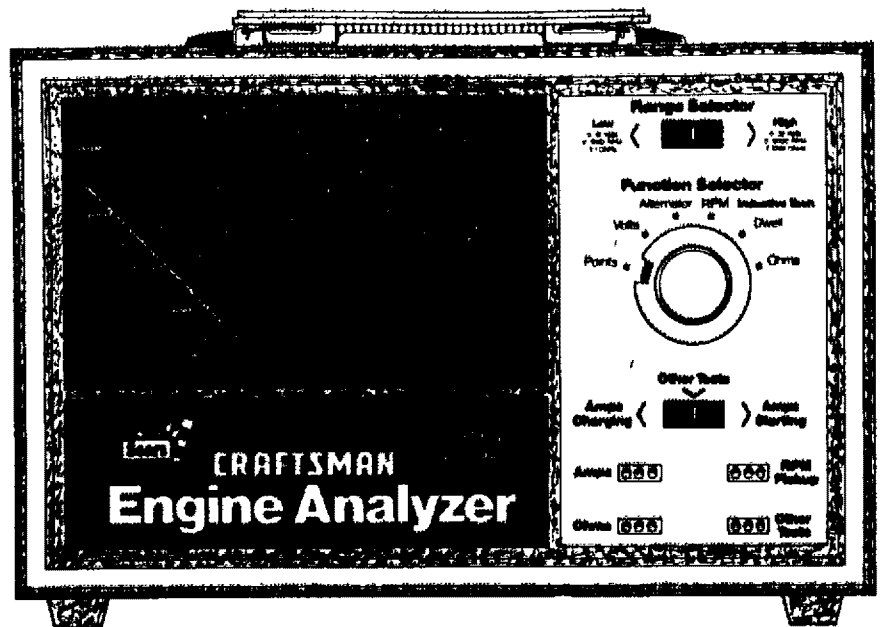

CRAFTSMAN

ENGINE ANALYZER

FOR 12 & 24 VOLT SYSTEMS

- OPERATING INSTRUCTIONS
- SAFETY RULES
- TUNE-UP PROCEDURES
- REPAIR PARTS

SEARS, ROEBUCK AND CO. U.S.A.
CHICAGO, ILLINOIS 60684

TABLE OF CONTENTS

	PAGE
INTRODUCTION, SERVICE PUBLICATION INFORMATION, WARRANTY	1
RULES FOR SAFE AUTOMOTIVE TESTING	2
INSTRUMENT FRONT PANEL CONTROL LAYOUT	3
FUNCTION SELECTOR SWITCH DESCRIPTION	4
ACCESSORIES	5
ENGINE HOOK-UP PROCEDURE--BREAKER POINT SYSTEMS	6
ENGINE HOOK-UP PROCEDURE--ELECTRONIC IGNITION SYSTEMS	7
TEST NUMBER 1--STARTING AND CRANKING VOLTAGE	8
TEST NUMBER 2--STARTER CURRENT DRAW	8
TEST NUMBER 3--STARTER CIRCUIT VOLTAGE LOSS	9
TEST NUMBER 4--CHARGING SYSTEM VOLTAGE AND CURRENT	10
TEST NUMBER 5--ALTERNATOR CONDITION	14
TEST NUMBER 6--ALTERNATOR FULL FIELD	14
TEST NUMBER 7--VOLTAGE REGULATOR	15
TEST NUMBER 8--BATTERY	15
TEST NUMBER 9--OHMMETER USE/ALTERNATOR DIODE TESTS	16
TEST NUMBER 10--ALTERNATOR ROTOR AND STATOR	18
TEST NUMBER 11--PRIMARY COIL VOLTAGE	18
TEST NUMBER 12--BREAKER POINT RESISTANCE	20
TEST NUMBER 13--DWELL ADJUSTMENT--BREAKER POINT SYSTEMS	21
TEST NUMBER 14--DWELL VARIATION	24
TEST NUMBER 15--DWELL ANGLE ELECTRONIC IGNITION SYSTEMS	25
TEST NUMBER 16--INITIAL IGNITION TIMING	29
TEST NUMBER 17--TIMING ADVANCE SYSTEMS	29
TEST NUMBER 18--CARBURETOR ADJUSTMENT MIXTURE (AIR-FUEL RATIO)	32
TEST NUMBER 19--CARBURETOR ADJUSTMENT--CURE IDLE SPEED	33
TEST NUMBER 20--THROTTLE KICKING SOLENOIDS	33
TEST NUMBERS 21 & 22--FAST IDLE AND AUTOMATIC CHOKE ADJUSTMENT	34
TEST NUMBER 23--IGNITION COIL	35
TEST NUMBER 24--IGNITION CABLES	37
TEST NUMBER 25--BALLAST RESISTOR	38
TEST NUMBER 26--IGNITION SWITCH	39
INTRODUCTION TO ELECTRONIC IGNITION SYSTEMS	40
GENERAL MOTORS HEI DISABLING PROCEDURES	41
TEST NUMBER 27--AMERICAN MOTORS ELECTRONIC IGNITION SYSTEM	42
TEST NUMBER 28--CHRYSLER ELECTRONIC IGNITION SYSTEM	44
TEST NUMBER 29--FORD ELECTRONIC IGNITION SYSTEM	46
TEST NUMBER 30--GENERAL MOTORS HEI--INTEGRAL COIL	48
TEST NUMBER 31--GENERAL MOTORS HEI--EXTERNAL COIL	50
TEST NUMBER 32--GENERAL MOTORS C-3/C-4 SYSTEM	52
TEST NUMBER 33--GROUND STRAP TEST--ENGINE TO BODY	53
TEST NUMBER 34A--FUSE TESTS	55
TEST NUMBER 34B--HORN	56
TEST NUMBER 34C--LOW VOLTAGE DROP TESTS	57
TEST NUMBER 34D--EMISSION CONTROL SYSTEM SOLENOIDS	58
TEST NUMBER 34E--LAMPS	58
TEST NUMBER 34F--MOTOR WINDINGS	58
TEST NUMBER 34H--REAR WINDOW DEFROSTER GRID	59
TEST NUMBER 34H--ELECTRICAL WIRING HARNESS	59
REPLACEMENT PARTS DIAGRAM	60
REPLACEMENT PARTS LIST	61

IMPORTANT

The information in this manual will serve as a general guide for engine tune-up and charging system tests and adjustments.

CONSULT THE VEHICLE SERVICE MANUAL FOR SPECIFIC TUNE-UP INFORMATION AND TEST PROCEDURES. ALWAYS FOLLOW THE MANUFACTURER'S SPECIFICATIONS AND TEST PROCEDURES FOR ADJUSTING DWELL ANGLE, IDLE SPEED AND CHARGING SYSTEM OUTPUT, ESPECIALLY VEHICLES WITH MODERN ELECTRONIC IGNITION AND EMISSION CONTROLS. DO NOT ATTEMPT TO SERVICE VEHICLE WITHOUT MANUFACTURER'S INSTRUCTIONS.

The following is a list of publishers who have service manuals available for your specific vehicle at a nominal cost. Write to them for availability and prices, specifying the make, style, and model year of your vehicle.

A. E. A. Tune-Up Charts
Automotive Electric Assn.
1301 W. 22nd St., Suite 202
Executive Plaza Building
Oak Brook, Illinois 60521

Chilton's Auto Repair Manual
Chilton Company
56th and Chestnut Streets
Philadelphia, Pennsylvania 19139

GM Diagnosis and Repair Manual
GM DR Manual Headquarters
P. O. Box 1185
Southfield, Michigan 48075

Motor's Auto Repair Manual
250 W. 55th Street
New York, N. Y. 10019

National Service Data Book
National Automotive Service, Inc.
Div. Glenn Mitchell Manuals, Inc.
Box 10465
San Diego, California 92110

Chrysler Corporation
Service Publications Dept.
26001 Lawrence Ave.
Center Line, Michigan 48015

Helm Incorporated
P. O. Box 07150
Detroit, Michigan 48207

FULL 1 YEAR WARRANTY

IF, WITHIN 1 YEAR FROM THE DATE OF PURCHASE, THIS AUTOMOTIVE TEST INSTRUMENT FAILS DUE TO A DEFECT IN MATERIAL OR WORKMANSHIP, RETURN IT TO THE NEAREST SEARS STORE THROUGHOUT THE UNITED STATES, AND SEARS WILL REPAIR OR REPLACE IT, FREE OF CHARGE.

THIS WARRANTY GIVES YOU SPECIFIC LEGAL RIGHTS, AND YOU MAY ALSO HAVE OTHER RIGHTS WHICH VARY FROM STATE TO STATE.

SEARS, ROEBUCK AND CO.
DEPARTMENT 698/731A
SEARS TOWER
CHICAGO, IL 60684

RULES FOR SAFE AUTOMOTIVE TESTING READ CAREFULLY

1. Read this Owner's Manual and these Rules for Safe Automotive Testing carefully. Failure to follow instructions and safety rules could result in serious bodily injury and/or damage to the instrument.
2. Before starting the engine, set the parking brake and place gear selector in NEUTRAL on standard transmissions or PARK on automatic transmission.
3. The carbon monoxide in exhaust gas is highly toxic. To avoid asphyxiation, always operate vehicle in a well-ventilated area. If vehicle is in an enclosed area, exhaust should be routed directly to the outside via leakproof exhaust hose.
4. When operating any test instrument from an auxiliary battery, connect a jumper wire between the negative terminal of the auxiliary battery and chassis ground on the vehicle under test for negative ground systems. For positive ground systems, connect the jumper wire to the positive terminal of the auxiliary battery and chassis ground on the vehicle. When working in a garage or other enclosed area, auxiliary battery should be located at least 18 inches above the floor to minimize the possibility of sparks igniting gasoline vapors and causing an explosion.
5. An automobile battery is capable of producing very high currents. Therefore, exercise reasonable care when working near the battery to avoid electrical connections through tools, wristwatch, etc.
6. Avoid contact with battery electrolyte. It can eat holes in clothing, burn skin and cause permanent damage to eyes. Always wear splash proof safety goggles when working around the battery. If battery electrolyte is splashed in the eyes or on skin, immediately flush the affected area for 15 minutes with large quantities of clean water. In case of eye contact, seek medical aid.
7. The gases generated by a charging battery are highly explosive. Do not smoke or permit flame or spark to occur near a battery at any time, particularly when it is charging. Any room or compartment containing charging batteries should be well ventilated to prevent accumulation of explosive gases. To avoid sparks, do not disturb the battery charger connections while battery is charging, and always turn charger off before disconnecting the battery clips. When removing or reconnecting battery cables, make sure ignition switch and all accessories are turned off.
8. Never add acid to a battery once the battery has been placed in service. Doing so may result in dangerous spattering of electrolyte.
9. Keep hands, hair, necktie, loose clothing and test leads well away from fan blade, fan belt, power steering belt, air conditioner belt and other moving engine parts, as serious injury could result from entanglement.
10. Do not touch hot exhaust manifold, radiator or high-voltage spark plug and coil terminals. Spark voltages are not normally lethal but an involuntary jerk of the hands or arms caused by electrical shock may result in injury.
11. Never look directly into carburetor throat while engine is cranking or running. A sudden backfire can cause serious burns.
12. To avoid the possibility of a flash fire, do not smoke or permit flame or spark to occur near carburetor, fuel line, fuel filter, fuel pump or other potential sources of spilled gasoline or gasoline vapors.
13. Never remove radiator cap while the engine is hot. Hot coolant escaping under pressure can cause serious burns.
14. The jack supplied with the vehicle should be used only for changing wheels. Never crawl under car or run engine while vehicle is on jack.
15. When making electrical test connections to the vehicle, do not use the carburetor or other fuel system components as a ground connection, as a spark could ignite the gasoline vapors and cause a fire or an explosion.

DESCRIPTION

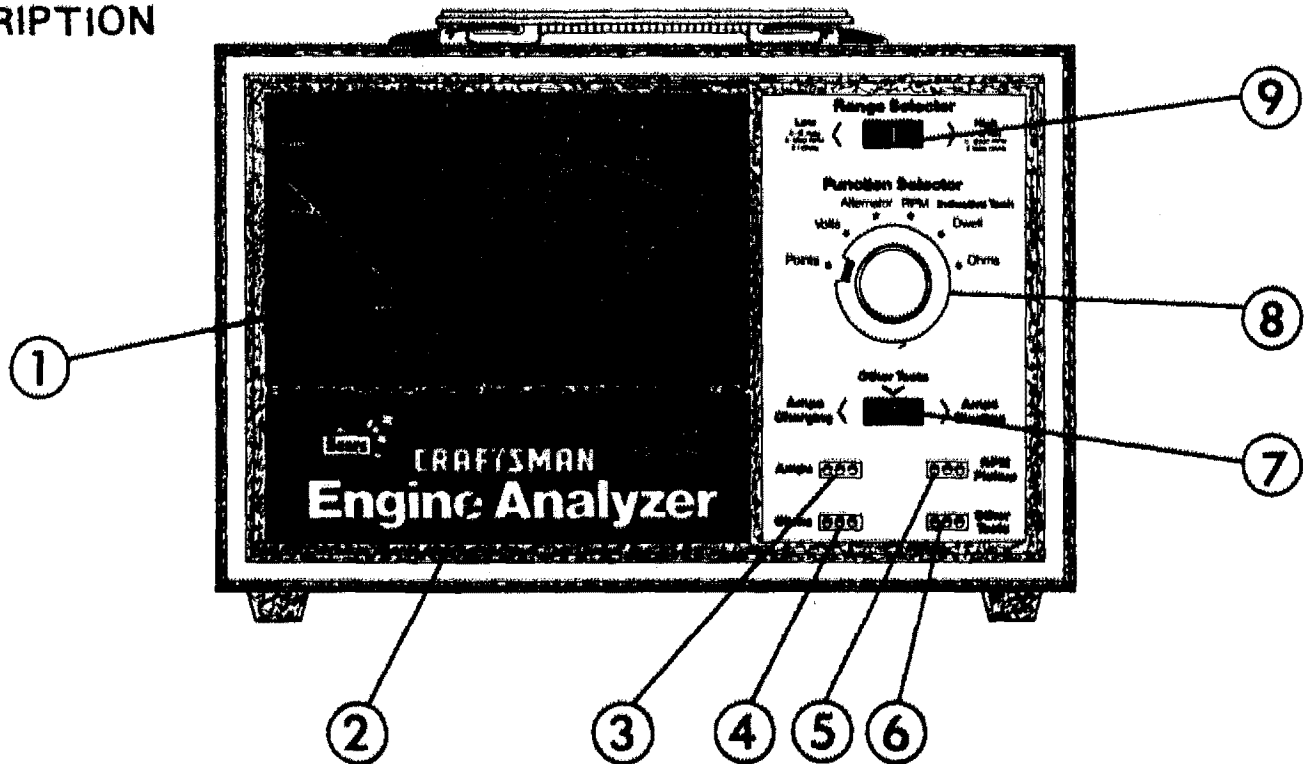

FRONT PANEL AND CONTROLS

FIGURE 1

1. **METER.** Provides following scales-
 Low Ohms X 1, 0 to 1,000 Ohms (10 Ohms center scale), Hi Ohms X 1,000, (10,000 Ohms center scale), RPM Hi 0-6000, Lo 0-1200 RPM, Volts 0-16 Lo, 0-32 Hi. Dwell 8 cyl. 0-45°, 4 cyl. 0-90°, 6 cyl. 0-60°, Amps, Points 0-3.2 Volts, Alternator-good/defective zones.
2. **ZERO ADJUSTER.** Meter pointer adjustment. If pointer is not on zero, slowly rotate this plastic slotted screw right or left to set pointer on zero line. Check before testing.
3. **RED AMPS SOCKET.** Insert RED plug on Amps lead.
4. **WHITE OHMS SOCKET.** Insert WHITE plug on Ohms lead.
5. **BLUE RPM PICK UP SOCKET.** Insert Blue plug on inductive pickup lead.
6. **BLACK - OTHER TESTS SOCKET.** Insert BLACK plug on test lead.
7. **OTHER TESTS SELECTOR SWITCH.** Always place switch in CENTER position for all tests, indicated by function switch (No.8) above. Use left hand position for charging Amps and right hand position for starting Amps. ALWAYS return switch to center position when Amps test is completed.
8. **FUNCTION SELECTOR SWITCH.** Used to select meter range for each test. A description of each test function is described on page 4.
9. **RANGE SELECTOR SWITCH.** Select for HIGH or LOW scale range for VOLTS, RPM, or OHMS depending on the test being performed.

Function Selector

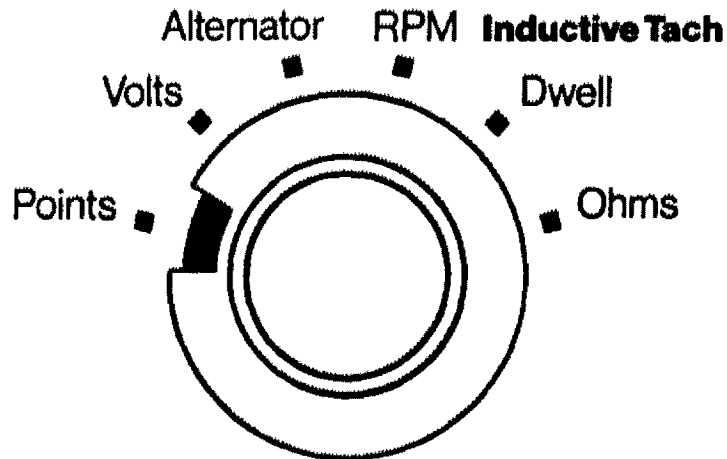

FUNCTION SELECTOR SWITCH POSITIONS

FIGURE 2

1. **POINTS.** 3.2 Volt Lo scale—provides point condition on scale. Also used for locating voltage drops in electrical starting and charging system.
2. **VOLTS.** Used to indicate battery charging and starting conditions. Use 16 volt Lo scale for 12 volt systems, and 32 volt (Hi) scale for 24 volt systems.
3. **ALTERNATOR.** Indicates alternator condition on GOOD or DEFECTIVE scale with engine running. It will detect open or shorted diodes or windings.
4. **RPM.** Provides 1200 or 6000 RPM engine speed reading. See item #9 Page 3. Use Lo-1200 RPM range for all Lo speed carburetor idle tests and Hi- 6000 RPM range for high speed tests.
5. **DWELL.** Used to check point dwell on breaker point ignition systems. Read 45° scale for 8 cyl., 60° scale for 6 cyl, and 90° scale for 4 cyl. engines.
6. **OHMS.** Hi & Lo - used to measure electrical resistance in Ohms, on ignition cables, ballast resistors, or ignition coil windings. Select Hi or Lo position. See Item #9 Page 3.

IMPORTANT: The above function tests will NOT WORK on meter unless other tests selector switch, ITEM No. 7 Page No. 3) is in CENTER POSITION for OTHER TESTS.

NOTE: The Ohms test operates from an internal 9 volt battery and incorporates automatic internal zero calibration. No external zero adjustment is required.

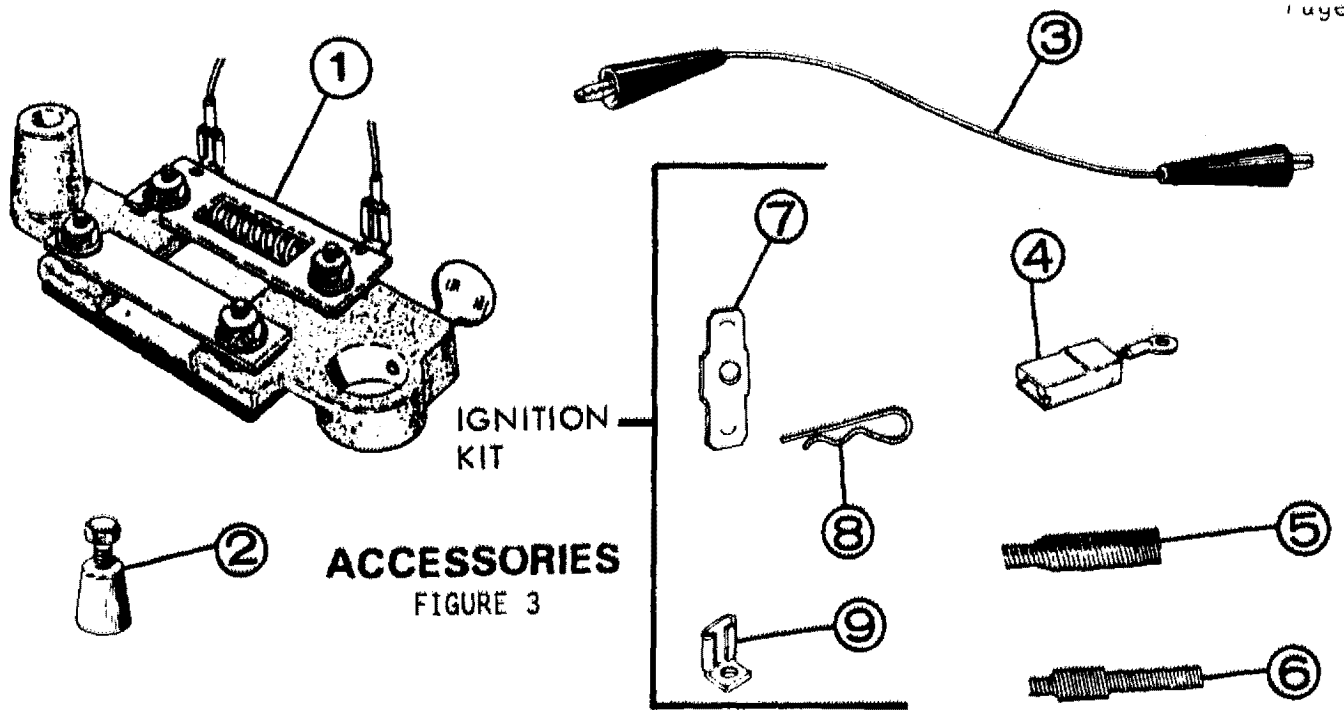

1. BATTERY POST ADAPTER. Used in electrical systems tests with 100 Amp and 400 Amp shunts.
2. SIDE MOUNT ADAPTER. Used with Battery Post Adapter on batteries with side terminals.
3. JUMPER LEAD. Used in electrical systems tests.
4. ALTERNATER FIELD PLUG CONNECTOR. Used in "A" & "B" circuit alternator output tests.
5. DOMESTIC SPARK PLUG ADAPTER. Used to make ignition cable tests.
6. FOREIGN SPARK PLUG ADAPTER. Used to make ignition cable tests.
7. G.M. DIAGNOSTIC CONNECTOR ADAPTER. Used to make tests on G.M. cars equipped with the diagnostic connector.
8. PRIMARY COIL ADAPTER. Used to provide easy hook-up on ignition systems with insulated coil primary connections.
9. H.E.I. ADPTER. Used to provide Dwell connection on G.M. H.E.I. systems.

TEST LEADS

FIGURE 4

The plugs and sockets are polarized to insure correct attachment. The socket has a groove on each top corner. The plug has a mating ridge on the inside of the top corners.

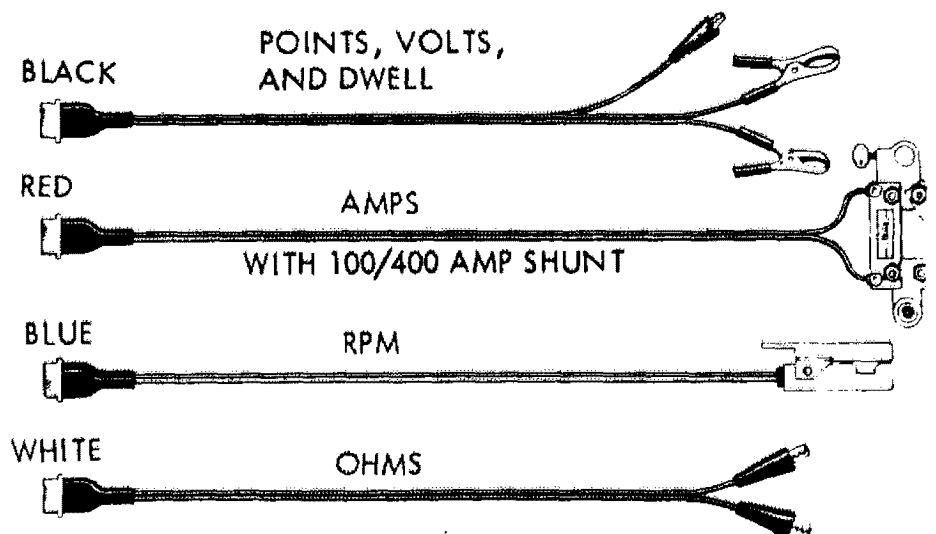
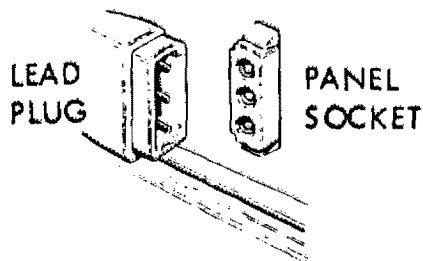

CONNECTIONS FOR ENGINE TESTS BREAKER POINT CONVENTIONAL IGNITION SYSTEMS

1. METER ZERO ADJUSTER. Before connecting any test leads, always check meter pointer zero position. If not on zero, slowly rotate adjuster with proper size flat screwdriver and set pointer on zero line.
2. LEADS. Insert all three test leads into matching color sockets on panel. Connect leads as illustrated below.
3. Install battery post adapter on the negative ground battery terminal as shown.
4. Connect RED clip to battery positive (+) terminal.
5. Connect BLACK clip to battery negative (-) GRD terminal.
6. Connect the GREEN clip to the distributor terminal on coil primary.
7. Attach RPM induction pickup to a spark plug cable as close to distributor cap as possible. Jaws must be fully closed.
8. DO NOT connect OHMS clip.
9. Engine must be at operating temperature before testing. Proceed with tests as outlined in this manual.
10. Starter Amp shunt must remain closed at all times except for charging system test as indicated. Damage to Battery Adaptor can occur if the above instruction is not followed.

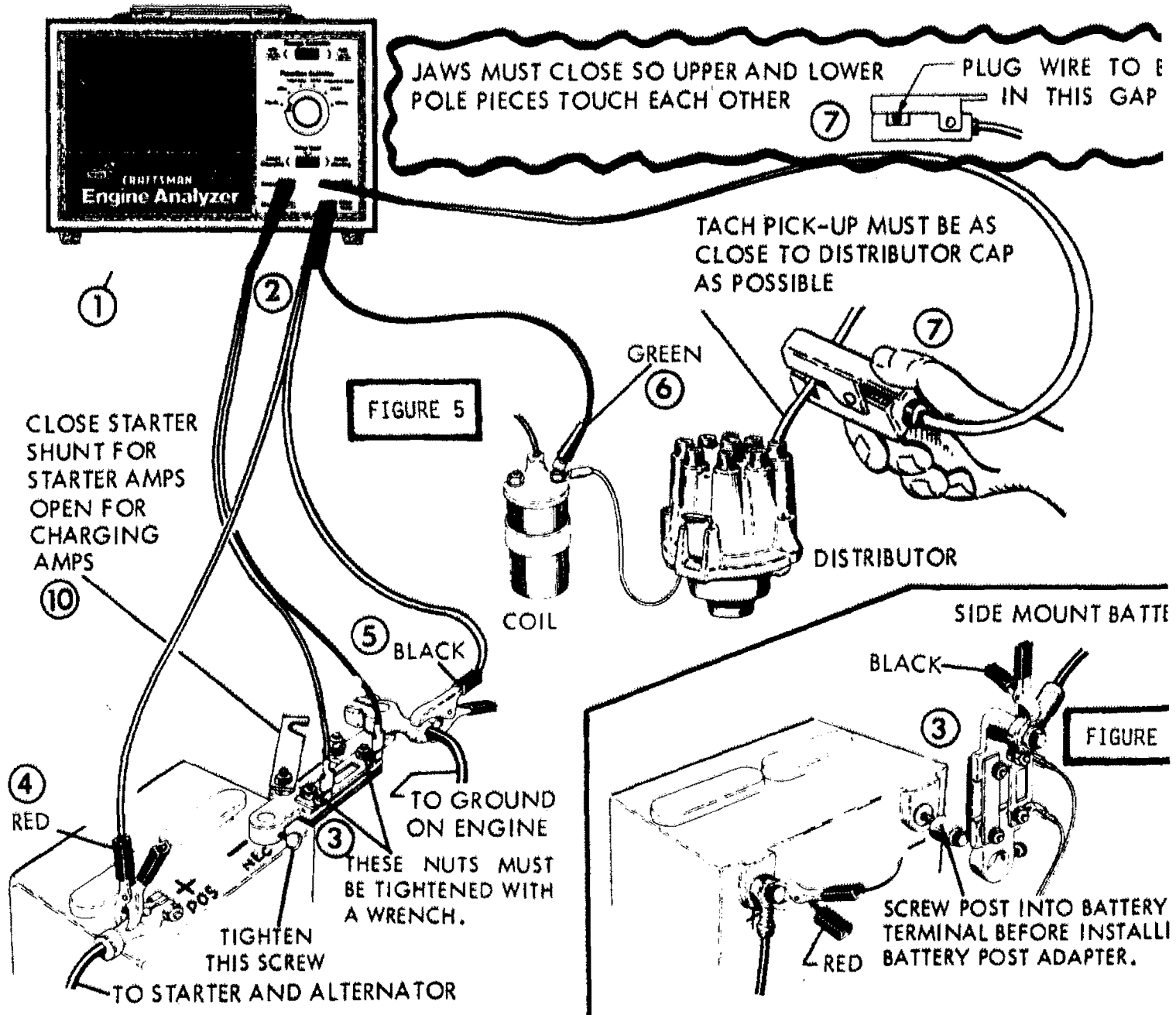

CONNECTIONS FOR ENGINE TESTS ELECTRONIC IGNITION SYSTEMS

Connect test leads as instructed on previous page for BREAKER POINT systems and as illustrated below with the following exception; See Test Number 15 for proper connection of the GREEN clip.

Proceed with tests as outlined in this manual--Omitting those tests which apply only to BREAKER POINT SYSTEMS

Engine must be at operating temperature before testing.

* Always close starter shunt before starting engine.

SEE PAGE No. 6 FOR NUMBER IDENTIFICATION.

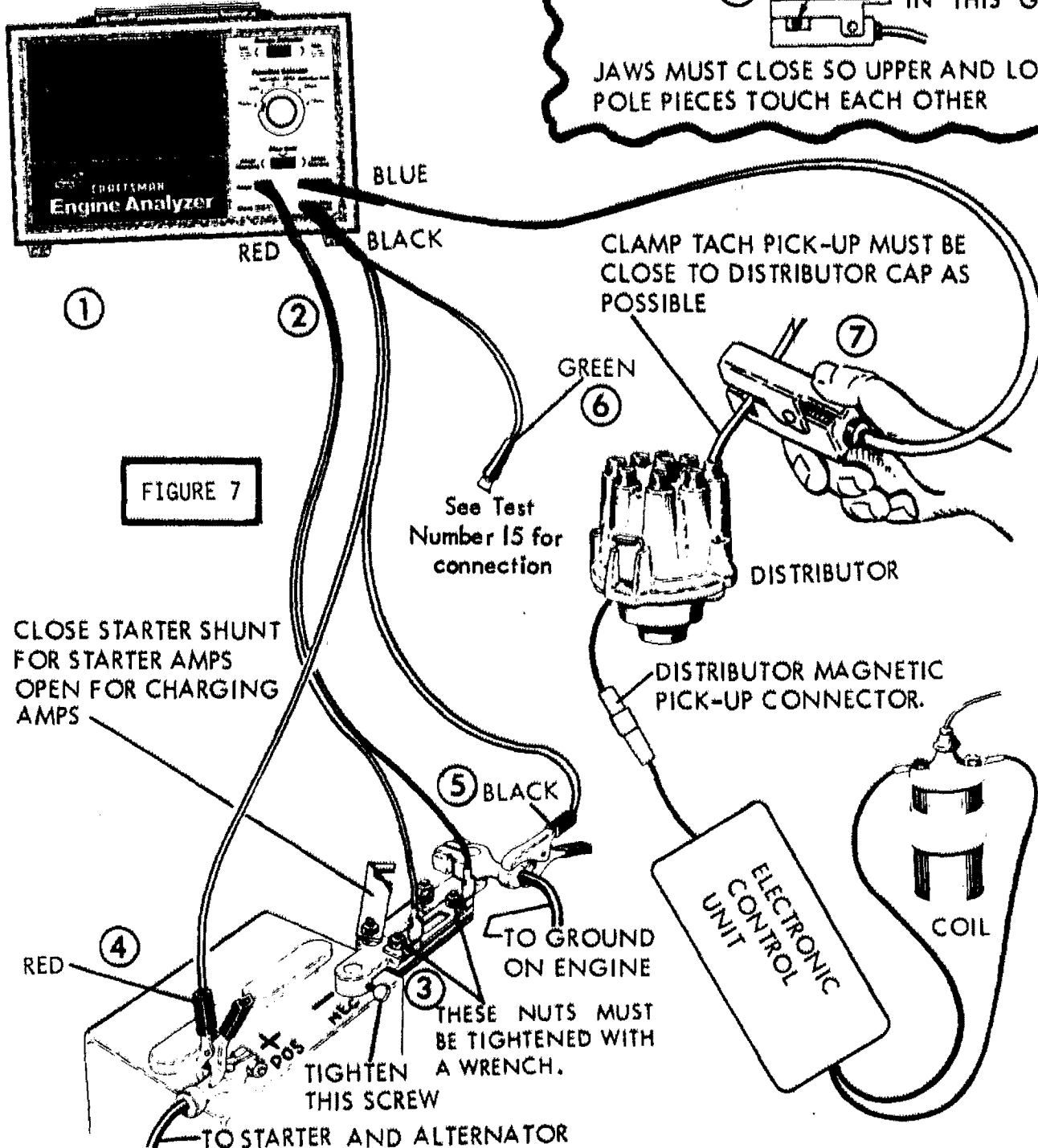
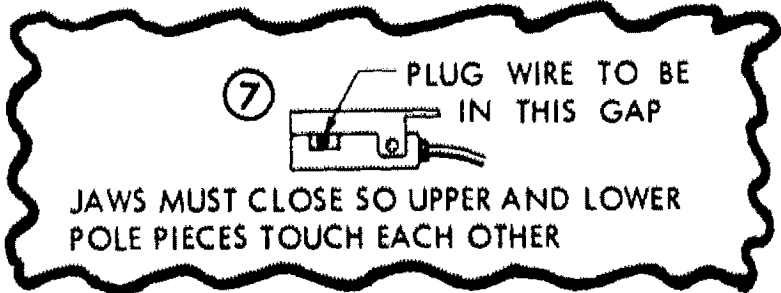
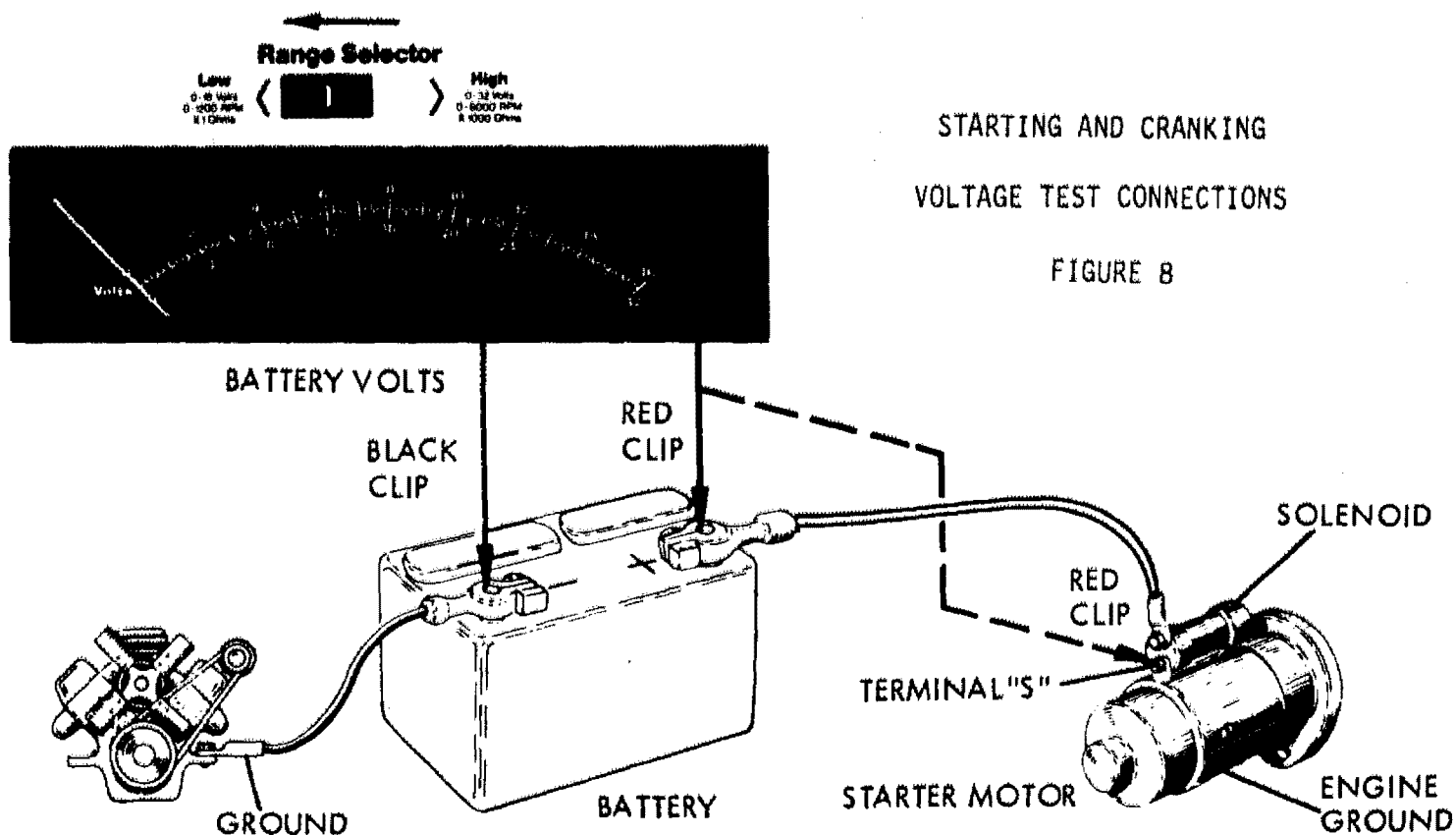

FIGURE 7

Test Number 1--Starting and Cranking Voltage

1. Place function switch in the VOLTS position. Engine must be disabled to prevent starting for this test. On ELECTRONIC IGNITION, disconnect battery cable at coil or unplug pickup coil connector at distributor or ground HT secondary lead on any external coil system.
2. Close starter amp shunt (See page 6, Figure 6) before operating starter.
3. Have an assistant turn the ignition switch to the START position and operate starter for 15 seconds. Observe battery voltage reading with engine cranking, (Figure 8).
4. A battery in good, fully charged condition should read a steady 9 volts or more.
5. If the battery voltage reads below 9 volts, recharge battery to full charge condition.
6. Excessive fluctuating voltage reading (over 1 volt) can be caused by a starter in poor condition due to worn bearings, dirty commutator, a defective battery or corroded starter cables. Clean, tight connections are a must throughout the starter system.



STARTING AND CRANKING
VOLTAGE TEST CONNECTIONS

FIGURE 8

Test Number 2--Starter Current Draw

1. Place center slide switch to the right hand starter amps position. Operate starter and note starter current on the 400 Amp scale, (Figure 10). Compare to specifications. IMPORTANT--Always return switch to center position for other tests when amps reading is completed (Also see Figure 15).
2. If battery-starter test is normal (a steady reading over 9 volts), proceed to Test Number 4--Charging System Voltage and Current.

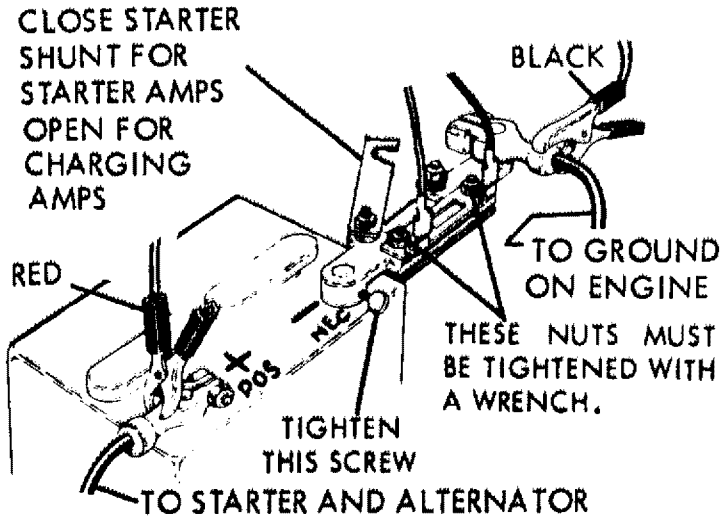

Connections For Starting & Charging Current Measurements

FIGURE 9

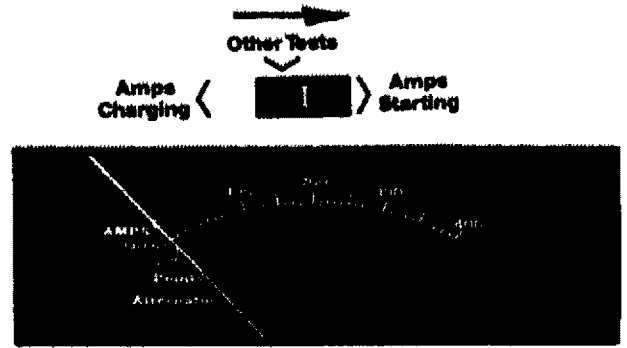

STARTER AMPS

Starter Current Switch Position

FIGURE 10

Test Number 3--Starter Circuit Voltage Loss

1. Disconnect all tester leads. Use only the BLACK PLUG battery-dwell lead for this test. Use the BLACK and GREEN test clip for voltage loss tests.
2. Place function switch in POINTS position and read 3 volt points scale. Each division is .1 volt.
3. Disable engine to prevent starting by grounding HV lead of the coil as shown below. On HEI or electronic systems disconnect battery lead at coil or unplug distributor pickup coil connector.
4. Refer to starter system illustrated below. Connect GREEN and BLACK clips across each section of circuit shown by numbers (1-2-3-4 etc.).
5. All readings must read .2 volts (2 div) or less for normal conditions. Reverse test leads if meter reads backwards.
6. High readings will be caused by corroded or loose connections at battery terminals, cables or a worn solenoid.

Connections For Voltage Loss Measurements

FIGURE 11

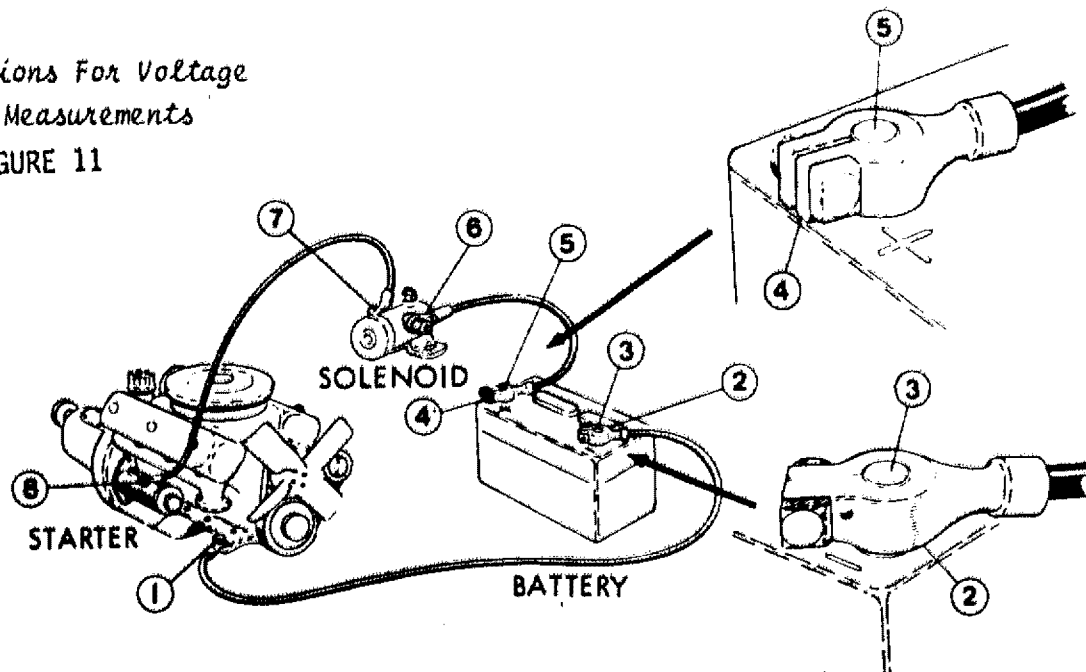

7. Remove and clean battery terminals and cable terminals in a warm water solution with baking soda to dissolve corrosion. Tighten nuts on starter solenoid terminals. Readings below 8 volts at the starter usually indicate a defective starter cable or burned solenoid contacts. Replace defective parts as required for good starter performance.
8. Replace worn or corroded cables as required to correct condition.
9. Do not crank for more than 15 seconds at a time. Allow starter motor to cool off for 30 seconds between tests.
10. When tests are completed, reconnect coil for normal starting.

Test Number 4--Charging System Voltage and Current

The function of the charging system is to keep the battery in an optimum state of charge, to provide the necessary current to start the engine, and operate the electrical systems when the engine is running. The battery is charged by an alternator that is driven by a belt connected to a pulley on the engine crankshaft. The alternator generates an alternating current (A. C.) that is converted by internal diodes into direct current (D. C.) to charge the battery. A regulator is needed in the charging system because the alternator output voltage increases as the engine speed increases. The regulator keeps the alternator output voltage at a safe upper limit so the battery will not be overcharged and the headlights and accessories will not be damaged by excessive voltage.

1. Place function switch in the VOLTS position. The Center Slide Switch must be in the OTHER TESTS position.
2. Slide the RANGE SELECTOR switch to the LOW range (0-16 volts) for 12 volt systems or to the HIGH range (0-32 volts) for 24 volt systems. Read test results on the appropriate VOLTS scale.
3. Be sure the shunts are in position on the Battery Amps Adapter as shown in Key No.1 Page 5 , before starting the vehicle.

CAUTION: TIGHTEN ALL NUTS ON THE BATTERY ADAPTOR FIRMLY WITH A WRENCH TO AVOID EXCESSIVE HEAT AND POSSIBLE SHUNT DAMAGE.

4. Before performing Step 5, start the engine and allow it to run for 10 to 15 minutes or until the engine compartment is warm, then shut it off. In order to obtain proper results from this test, the battery must be partially discharged. To accomplish this, switch on the headlights and put the blower on HIGH for a minimum of one minute, or remove the distributor wire to prevent the car from starting and crank the engine for about 30 seconds, then follow step 5.
5. Start the engine. Operate at a fast idle (approximately 1500 RPM). Open the starter amps shunt. Note the battery charging voltage. The meter should read over 12 volts and slowly rise to regulated voltage in a few minutes (15 1/2 volts maximum). (Figure 12)
6. Move the Center Slide Switch to the CHARGING AMPS position and note the alternator charging rate compared to vehicle specifications. (Figure 12) Shortly after starting, an alternator in good condition should charge from 50 to 80% of its rated capacity, and slowly decrease as the battery regains its charge. The charging voltage will slowly rise as the ampere rate decreases and maximum regulated voltage is obtained.
7. Move the Center Slide Switch to the OTHER TESTS position again for voltage reading and operate the engine at fast idle until the charging voltage stops increasing. Note the maximum voltage and compare to vehicle specifications.
8. If the charging voltage exceeds 15 1/2 volts or as specified, replace or adjust the voltage regulator. If the voltage reading is too high, the defect could be:

<u>DEFECT</u>	<u>ACTION</u>
A. High resistance in the ground circuit	Clean and tighten all ground connections
B. Regulator set too high	Adjust to the proper setting (If adjustment is possible) Most late model vehicles use a regulator which is of solid state design and cannot be adjusted. These must be replaced when they are defective.
C. Defective regulator	Replace Regulator

If the voltage reading is too low, the problem is either in the alternator, regulator, or the battery.

9. If charging voltage DOES NOT slowly INCREASE, this may indicate a defective alternator. Rotate the Function Switch to the alternator position, turn lights on and operate the engine at approximately 1200 RPM. Read the alternator scale. A reading in the gray defective zone indicates defective diodes or windings in which case the alternator diodes and windings are functioning properly. (Figure 12).

10. If a low or no charging rate is indicated, check alternator output under full field conditions by removing voltage regulator control action. (See pages 12 & 13 for connections.) To apply full field voltage for maximum output, refer to vehicle specifications to determine whether type "A" or "B" system is used for proper field bypass connections.

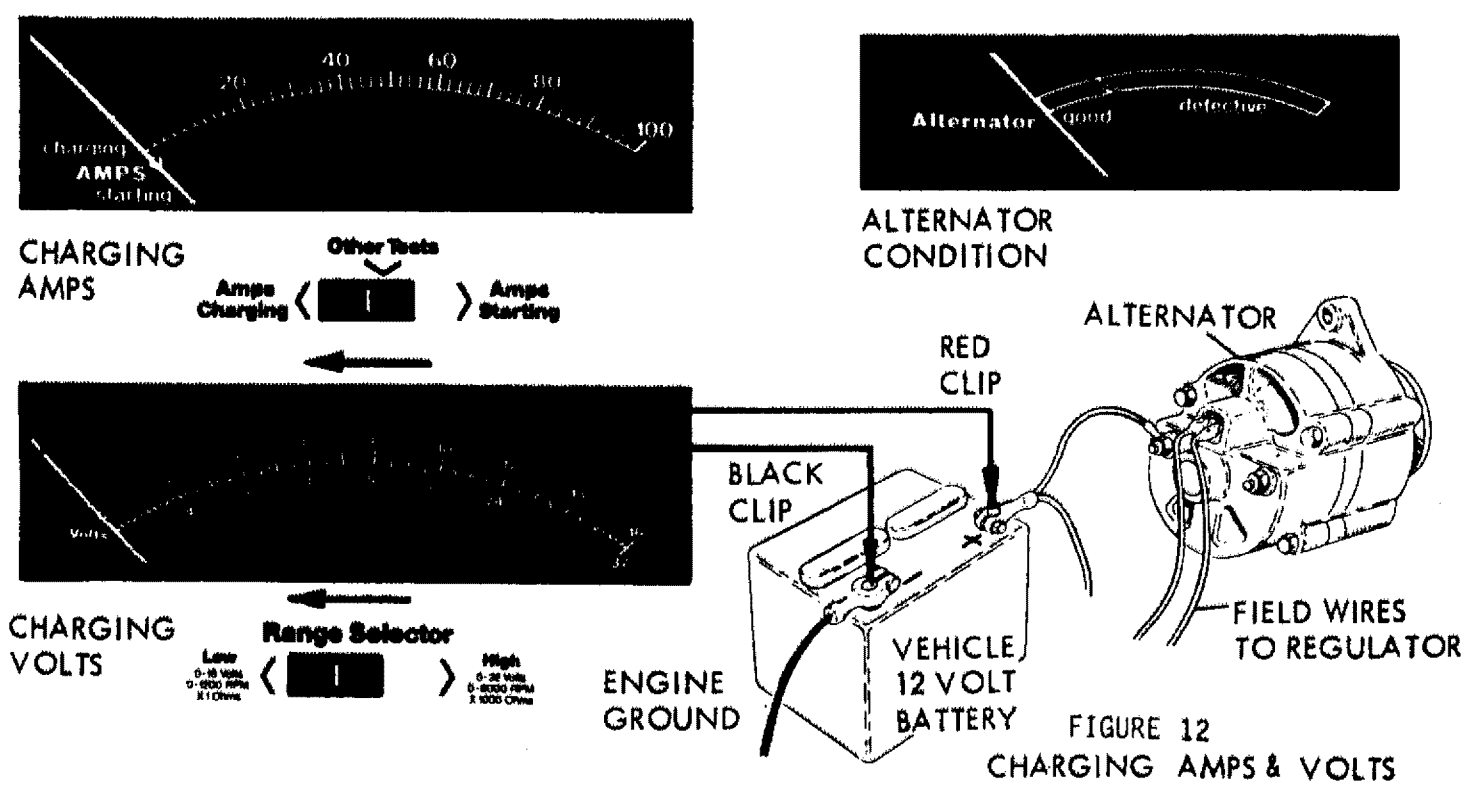

FIGURE 12
CHARGING AMPS & VOLTS

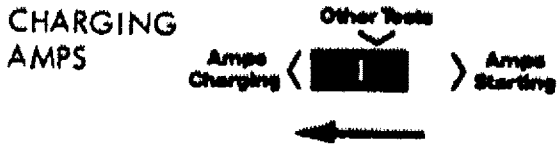
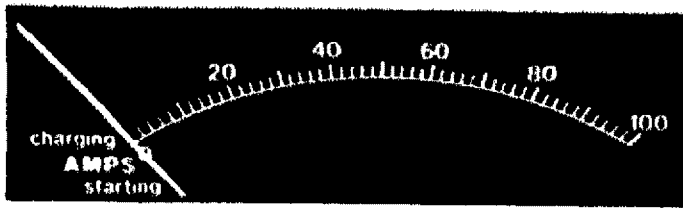
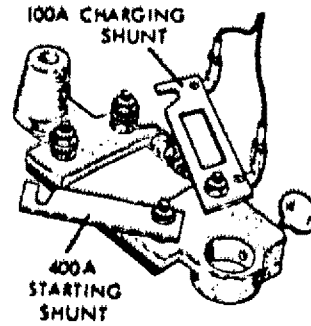

FIGURE 13



BATTERY POST ADAPTER CONNECTIONS FOR ALTERNATOR TEST

FIGURE 14

NOTE: If the AMPS indicates below zero (left) during CHARGING or STARTING, reverse the leads as shown.

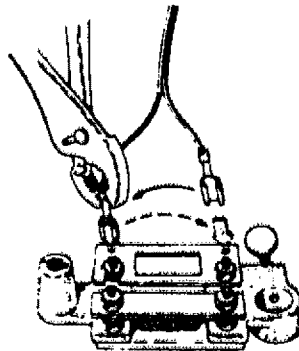

Caution: DO NOT pull on the wires. If necessary, grasp the terminal with pliers to remove it.

FIGURE 15

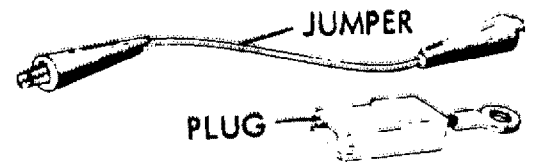
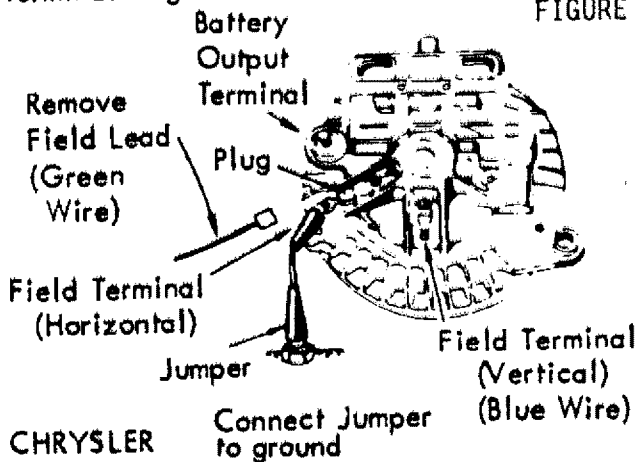

FIGURE 16

"A" CIRCUIT (Electronic Voltage Regulator)

Remove field lead (green wire) from the alternator field terminal. Connect jumper wire from the alternator field terminal to ground.

FIGURE 17 A



CHRYSLER

Insert screwdriver not more than 1 inch in end frame hole, ground tab to frame with screwdriver. No additional adapter is needed.

FIGURE 17 B

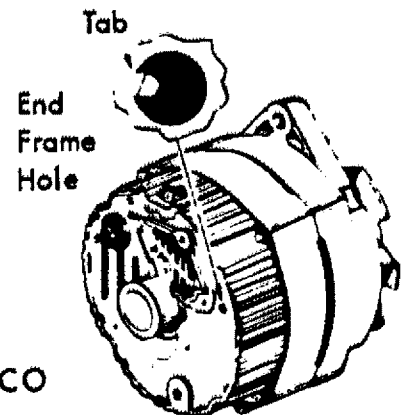

Remove cap from the field terminal. Connect jumper wire to field terminal and ground.

FIGURE 17 C

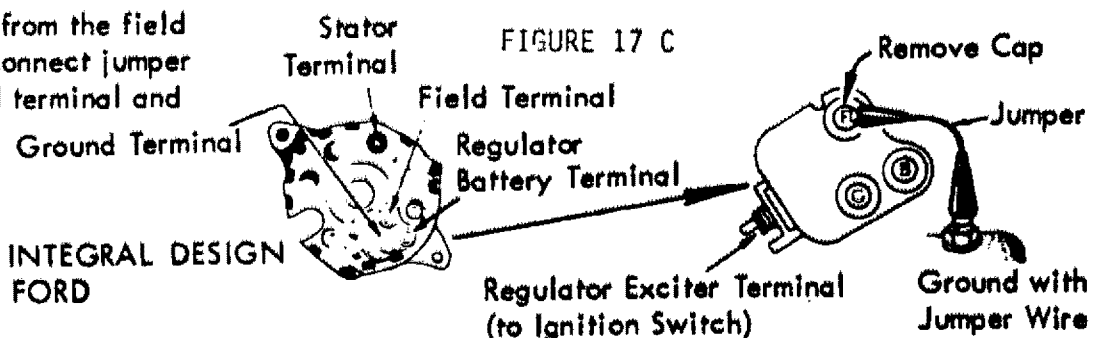

INTEGRAL DESIGN
FORD

"B" CIRCUIT (External Voltage Regulator)

FIGURE 18

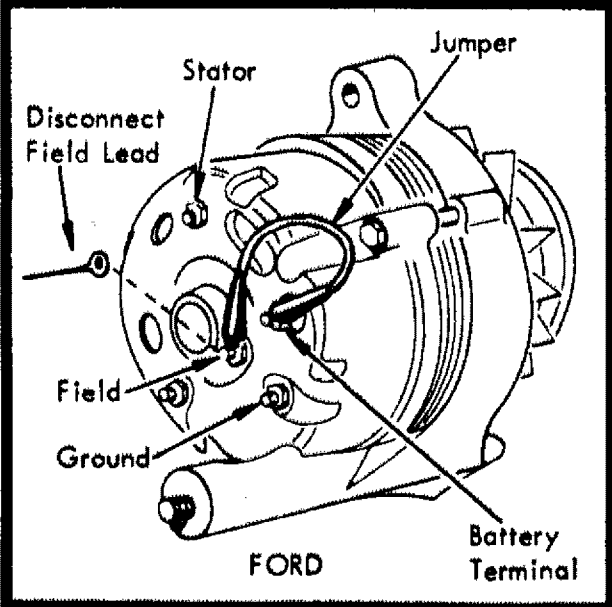
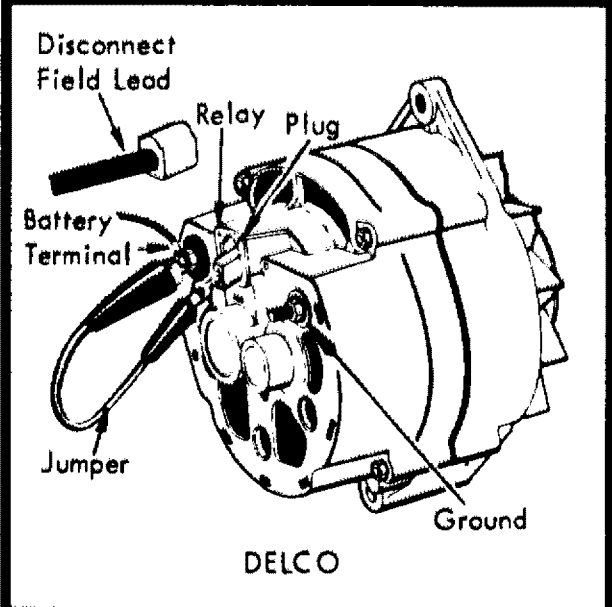
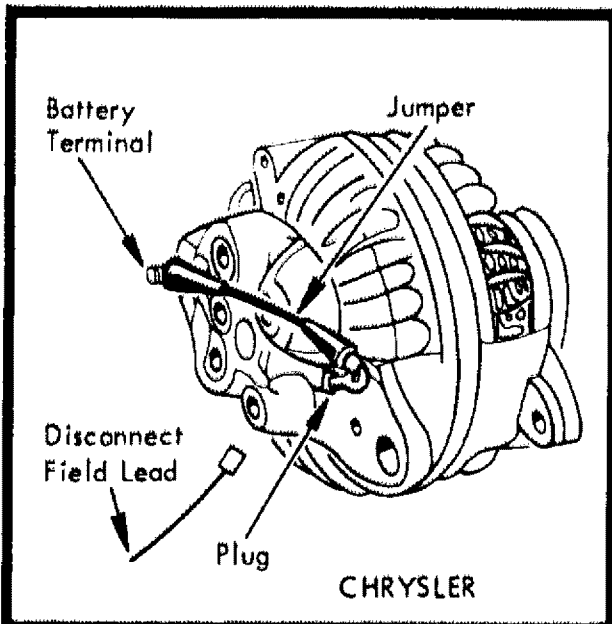

On some vehicles it may be inconvenient to connect the jumper wire at the alternator. In such a situation remove the regulator connector from the voltage regulator and connect a jumper wire as illustrated.

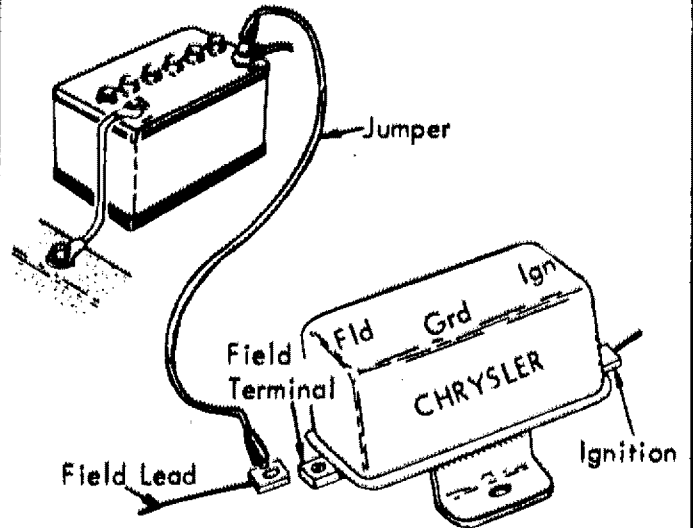

Remove field lead from field terminal. Connect jumper wire from positive terminal of battery to the field lead.

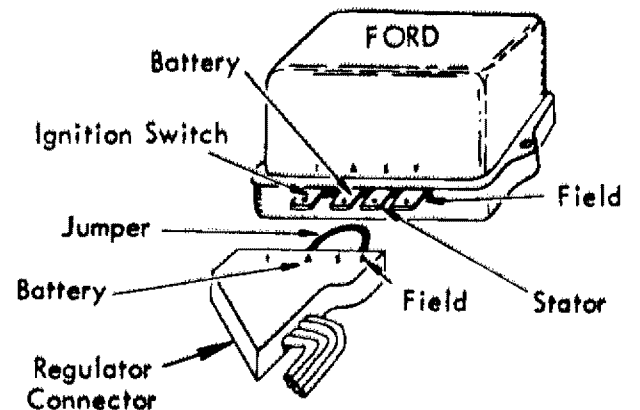
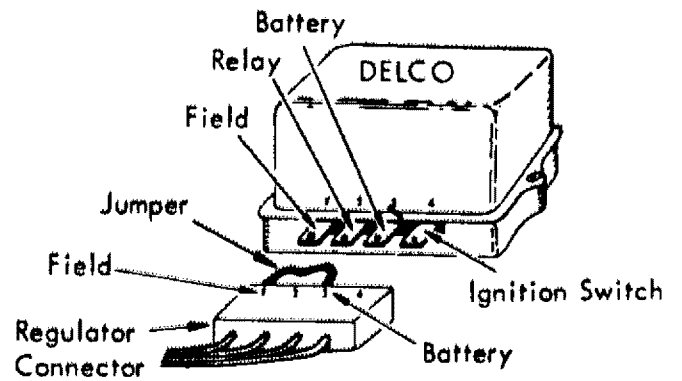

Test Number 5--Alternator Condition

1. Be sure the shunts are tightly secured to the Battery Amps Adaptor as shown in Key No. 1 Page 5 , and the Function Selector Switch is placed in the Alternator position.

CAUTION: TIGHTEN ALL NUTS ON THE BATTERY ADAPTOR WITH A WRENCH TO AVOID EXCESSIVE HEAT AND POSSIBLE SHUNT DAMAGE. IF YOU ATTEMPT TO START THE ENGINE WITH THE SHUNT DISCONNECTED, THE 1/4 OHM RESISTOR MOUNTED ON THE BATTERY ADAPTOR MAY BLOW OUT.

2. Start the engine, then carefully disconnect the slotted ends of the shunts as shown in the figure below. Turn the headlights on and operate the engine at approximately 1200 RPM and observe the alternator condition scale.
3. A reading in the RED GOOD ZONE on the meter indicates that the alternator windings and diodes are satisfactory.
4. A reading in the GRAY DEFECTIVE ZONE indicates that one or more diodes are open or shorted or that the stator winding is open or shorted to ground or has shorted turns. Refer to Tests 9 and 10 Alternator Diode, Stator and Rotor Tests for further testing.

Test Number 6--Alternator Full Field

IMPORTANT: Refer to vehicle specifications to determine whether type "A" or type "B" system is on the vehicle. Also check the rated output of alternator on the nameplate or specifications listing.

1. To perform this test, it is necessary to ground the field in the type A Circuit or remove the regulator from the charging system and energize the field in the Type B Circuit. This provides full field operation and the alternator will charge at its maximum rated capacity.
2. Place the FUNCTION SELECTOR Switch in the VOLTS position and slide the Center Slide Switch to the AMPS CHARGING position.
3. On the Type A Circuit, ground the field as shown on page 12 , proceed with Step 5 below.
4. On the Type B Circuit, disconnect the wiring harness plug from the regulator and energize the field as shown on page 13.
5. Before starting the vehicle, be sure the shunts are connected to the Battery Amps Adapter as shown in Key No. 1 on page 5 . Turn on the headlights and set blower speed to high. The meter should read to the left of zero or "backwards". If it reads up scale, reverse the shunt connections as shown in Figure 15.

Turn all lights and accessories "OFF". Start the engine and operate it at the speed recommended by the manufacturer for alternator output test. Unless otherwise specified, adjust engine speed as follows:

Chrysler	1250 RPM
GM-Delco-Remy	2500 RPM
Ford	2900 RPM

With the engine running, carefully open the starter shunt as shown in Key 10 on page 6 . Observe the current (amps) reading on the 0-100 Amps scale, reduce engine speed to curb idle and compare meter reading with the manufacturer's specifications.

ALTERNATOR FULL FIELD

NOTE: To determine the actual output current, add 5 amperes to the meter reading obtained during the output test. This is the approximate current used by the ignition system, dash instruments and alternator field coil combined which does not reach the battery to be measured during this test. If the meter reading is at or higher than specified, the alternator output is satisfactory. If the meter reading is less than specified, a loose or worn alternator drive belt, a faulty field or battery wire to the alternator, or a poorly grounded or defective alternator is indicated. If the meter reading is to the left of zero, a broken field wire or a defective alternator is indicated. (Meter reading is the battery discharge current used by the ignition system and dash instruments.)

6. When test is completed, shut off the engine, disconnect jumper lead, remove the shunt, and reconnect wiring harness plug, connector or field wire to the regulator for normal operation.

Test Number 7--Voltage Regulator

Repeat Test Number 4--Charging System Voltage and Current

If the voltage reading is within the range as specified by the vehicle service manual, (typically between 13.8 and 15.2 volts on 12 volt systems, and 27.6 and 30.4 on 24 volt systems) the regulator is satisfactory.

If the voltage reading is out of specifications but satisfactory operation was obtained on the CHARGING SYSTEM VOLTAGE AND CURRENT and ALTERNATOR CONDITION tests, the voltage regulator should be adjusted (if possible) or replaced.

Test Number 8--Battery

Repeat Test Number 4--Charging System Voltage and Current

After the VOLTAGE REGULATOR--TEST 7 is completed, the regulator should be functioning satisfactorily, leaving the battery as the only untested component remaining in the CHARGING SYSTEM. To test battery condition, attach the shunt to the BATTERY POST ADAPTER (Key 1 Page 5), start the engine, and operate it at approximately 1200 RPM. If the voltage reading is less than 13.8 volts, check the water level in the battery and fill to the proper level, if necessary. Charge the battery and repeat this test. If the voltage reading is still low, the battery is defective and should be replaced.

Test Number 9--Ohms Test

1. The ohmmeter test is powered by an internal 9 volt battery. No zero calibration is required by the operator. Place Function Selector Switch in the Ohms position and select either the Hi or Lo range to match the component under test. (X 1 or X 1000)
2. CONNECTIONS: Insert the white Plug Ohms Lead into the corresponding tester socket as illustrated below.
3. OPERATION: The meter will read full scale at INF. with clips open, and when the clips are connected together will read zero on the left. (See Paragraph #6.) To measure resistance, connect the clips to the component to be tested and read the proper Ohms scale. (X 1 or X 1000)
4. IMPORTANT CAUTION: ALWAYS disconnect ALL LEADS from any electrical part to be tested on the vehicle. Failure to observe this caution may result in damage to the tester.
5. Refer to manufacturer's specifications for normal resistance value of any part being tested, ignition cables, ballast resistor, coil windings, etc.

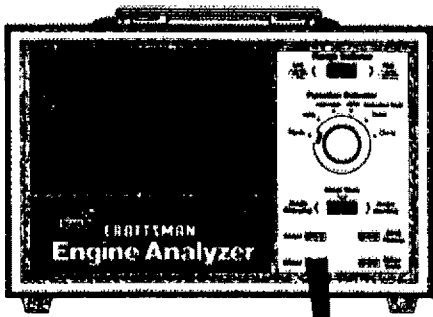
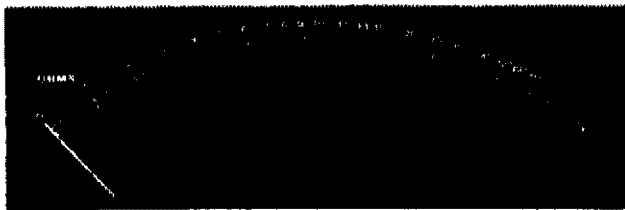

WHITE PLUG

OHMMETER BATTERY

The 9 volt battery is located in the rear compartment.

Observe correct polarity when installing battery.

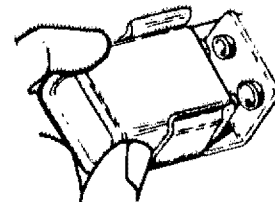

IMPORTANT: 9 VOLT BATTERY (SEARS # 6417) IS NOT SUPPLIED WITH THIS ANALYZER--OHMS CIRCUIT WILL NOT WORK WITHOUT BATTERY.

FIGURE 19

OHMMETER CONNECTIONS

RED BLACK

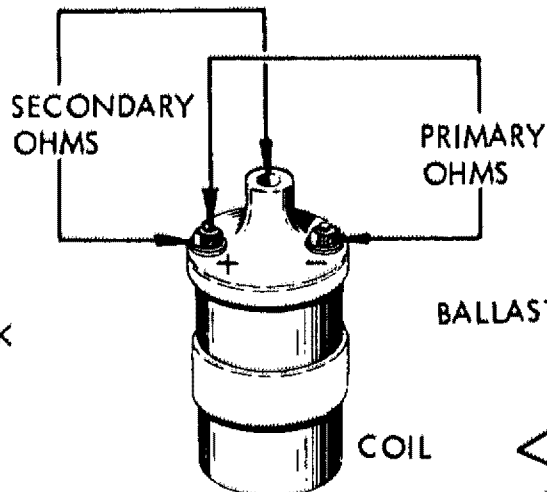

OHMS TESTS ON VARIOUS VEHICLE COMPONENTS

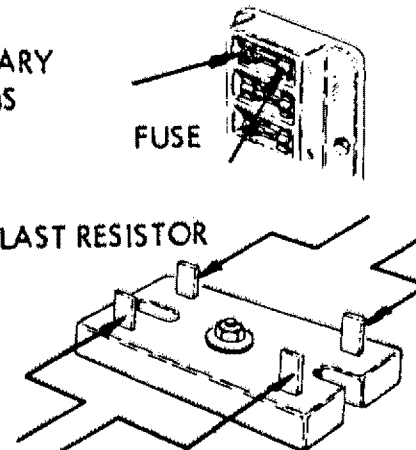

6. BATTERY REPLACEMENT. When the 9 volt battery is low, the meter will not read full scale with the clips open. Replace the battery to obtain accurate OHMS measurement.
7. IMPORTANT: When the tester is not in use or when Ohms tests are completed ALWAYS turn the Function Selector Switch OUT of the Ohms position to prevent battery discharge.

DIODE TESTS ON OHMS X 1000 POSITION

Alternator diodes in a disassembled alternator can be tested for "shorts" or "opens" with the stator leads disconnected as illustrated. To facilitate checking the diodes in the end frame and heat sink, place a short length of wire or nail in the jaws of the RED and BLACK test clips as shown in the illustration. Touch the RED lead to the diode case and the BLACK lead to the diode lead as illustrated in Step A and note the meter reading. Reverse the lead connections on the same diode and again note the reading as in Step B. A good diode will have one low and one high reading. If both readings are very low, or if both readings are very high, the diode is defective and should be replaced.

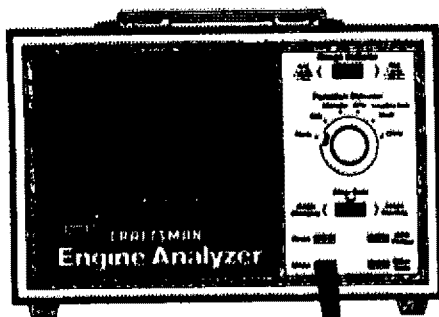
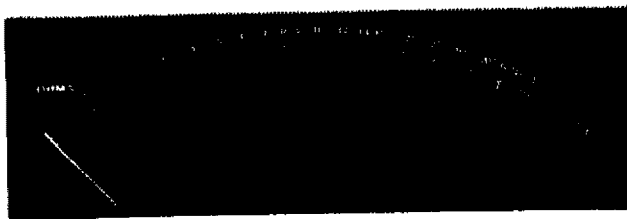

WHITE PLUG

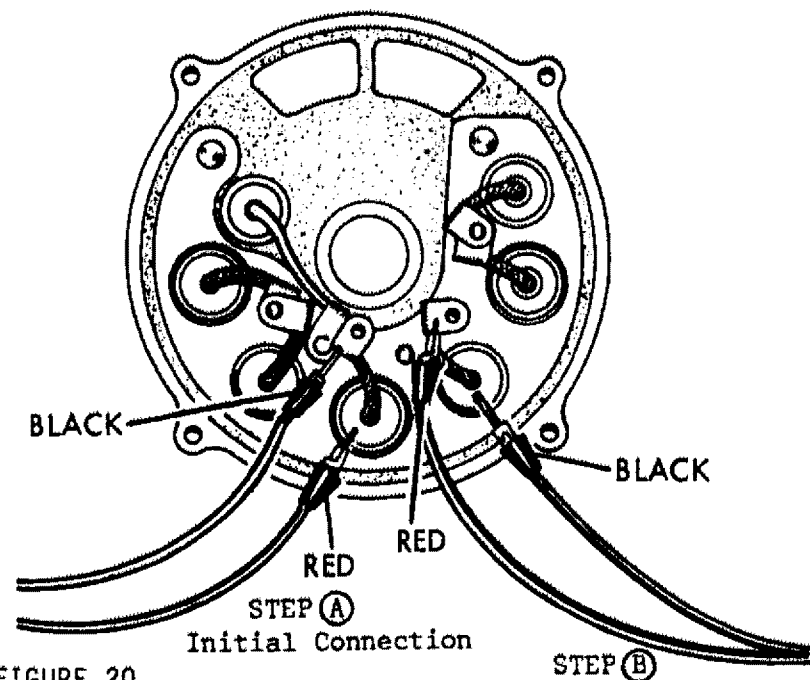

FIGURE 20

ALTERNATOR DIODE TESTS

Reverse
Connection

Test Number 10--Alternator Rotor and Stator

See steps 1-7 Test Number 9--Ohms Test for Ohmmeter use

ROTOR AND STATOR TESTS ON OHMS X 1000 POSITION

Rotor--

The alternator rotor may be tested for open or grounded field coils. To check for opens, touch the test leads to each slip ring. If the meter reading is near zero, (left end) the winding is not open. If the meter shows high reading (extreme right end of the scale), the winding is open and the alternator should be repaired or replaced. To check for grounds, touch the test leads from either slip ring to the rotor shaft or to the rotor poles. If the meter shows only a slight reading or none at all, the field winding is not grounded. If the meter reading is near zero (left end), the winding is grounded and the alternator should be repaired or replaced.

Stator--

The alternator stator windings may be checked for grounds or opens. Disconnect the three stator leads from the diodes before any test. To check for opens, successively connect the tester leads between each pair of stator leads. In each case, if the meter reading is near zero (left end), the windings are not open. If the meter shows a high reading, the winding is open and the alternator should be repaired or replaced. To check for grounds, connect the tester leads to each stator lead and to the frame. If the meter shows a full scale reading, the stator is not grounded. If the meter is near zero (left end), the stator winding is grounded to the frame and the alternator should be repaired or replaced.

Test Number 11--Primary Coil Voltage

The purpose of this test is to confirm the presence of supply voltage to the positive (+) or Battery (Bat) terminal of the Ignition Coil. NO VOLTAGE AT THIS POINT RESULTS IN A "NO START" CONDITION.

Perform this test as follows:

1. Place the Function Selector Switch of your Craftsman Analyzer in the VOLTS position. Place the RANGE SELECTOR in the 0-16 volts position.
2. Insert the BLACK OTHER TESTS lead in its corresponding socket on the Analyzer. Connect the BLACK clip to a good vehicle ground such as the engine block or negative (-) battery post. Connect the RED clip to the to the positive (+) or battery (Bat) terminal of the ignition coil. In the case of the General Motors HEI System, disconnect the pink battery (Bat) lead at the Distributor (on Integral Coil Systems) or at the coil (on External Coil Systems). Insert the GM Diagnostic Connector, Page 5 , Key No. 7 into the socket of this disconnected wire and connect the RED clip to the adaptor.

IMPORTANT: DO NOT ALLOW THIS CONNECTION TO TOUCH GROUND! THE GREEN CLIP IS NOT USED.

3. Turn the vehicle's Ignition Switch (key) to the "ON" or "RUN" position only. Do not start the engine.
4. Read the analyzer's voltmeter. Normal readings should be as follows:
Breaker Point Systems: At or slightly below battery voltage (12 volts) if the points are open. Approximately 6 to 8 volts if the points are closed. "Jog" the engine quickly to close the points if they are open. The meter reading will be significantly lower with the points closed as shown above.

If the Voltmeter stays at or very close to battery volts (12 volts) with the points closed, a problem exists in one or more of the following areas:

Ignition coil primary open, Pigtail from negative (-) or Distributor (Dist) side of coil to distributor open, points defective, or open ground within the Distributor.

If the Voltmeter stays at zero (no reading), a problem exists in the supply circuit to the Ignition Coil i.e. ballast resistor open (when equipped); ignition switch or related wiring open.

Electronic Ignitions: At or slightly below Battery Voltage (12 volts)

If the voltage is not as specified, see the proper diagnostic procedures relating to your vehicle ignition type as shown later in this manual. Your vehicle service manual is also a valuable tool in diagnosing Electronic Ignition problems.

Test Number 12--Breaker Point Resistance

NOTE: This test does not apply to Electronic Ignition systems.

NOTE: Remove the distributor cap before testing and inspect the contact points. If they are blued, blackened, or noticeably pitted, they should be replaced. Normal, used contact points are light gray in color.

1. Place the Function Selector Switch in the POINTS position.
2. Disable engine to prevent starting by removing coil secondary lead from distributor and connect to a good engine ground with jumper lead as illustrated below.
3. Have an assistant turn the ignition switch to the START position momentarily to crank engine slowly a little at a time until the points are closed as indicated by the lowest meter reading.
4. Points are in GOOD condition if the reading is .3 volts or less. Replace points if the reading is out of the good zone, or over .3 volts.
5. If the reading still exceeds .3 volts, check the distributor ground plate, (plate on which points are mounted), pigtail extension to primary lead inside distributor or primary lead to coil for breaks, or misaligned point contacts on points. Refer to your vehicle service manual for other tests relating to the Breaker Point Circuit.
6. When new points are installed, always clean and lubricate cam, check again for contact alignment, and resistance. Adjust to correct Dwell before starting--See Test Number 13 , Dwell Adjustment.
7. Correct the defect and repeat the test. When the points check OK, turn the ignition switch OFF. Reinstall the high tension lead in the center of the distributor cap.

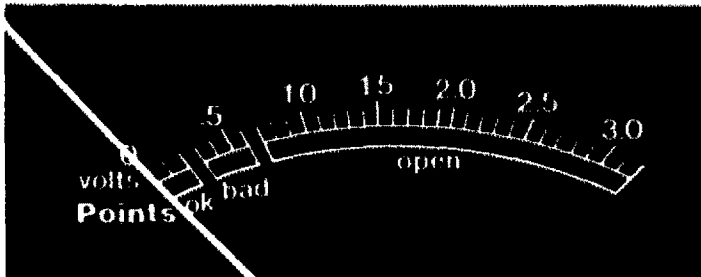
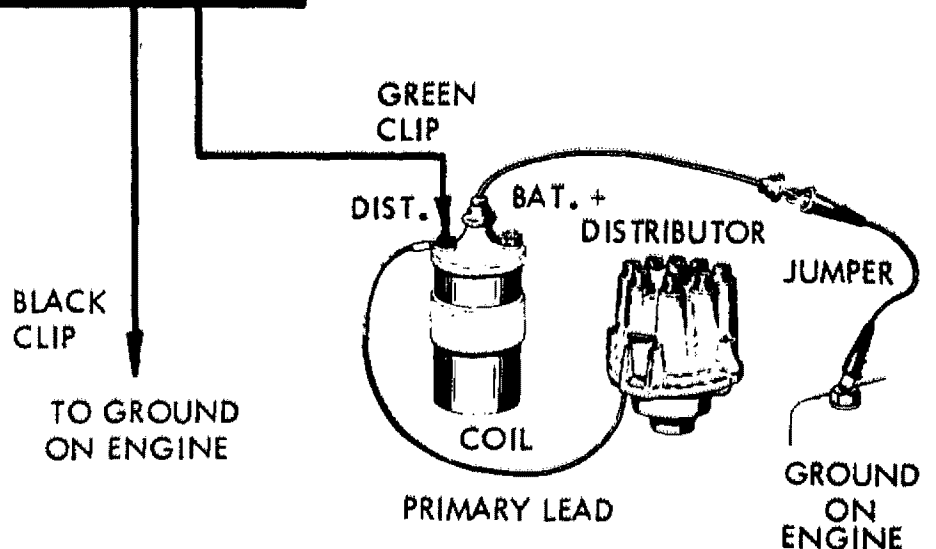

FIGURE 21

SECONDARY COIL CONNECTIONS
TO PREVENT ENGINE STARTING



Test Number 13--Dwell Adjustment--Breaker Point Systems

1. Rotate the Function Selector Switch to the dwell position.
2. Consult your vehicle service manual to determine which vacuum hoses, if any, should be disconnected and plugged prior to making dwell adjustment or test.
3. Run the engine at specified idle speed and note dwell reading on proper 4-6 or 8-cylinder scale to correspond to the engine under test.
4. Compare results to vehicle specifications; adjust to correct dwell if required.

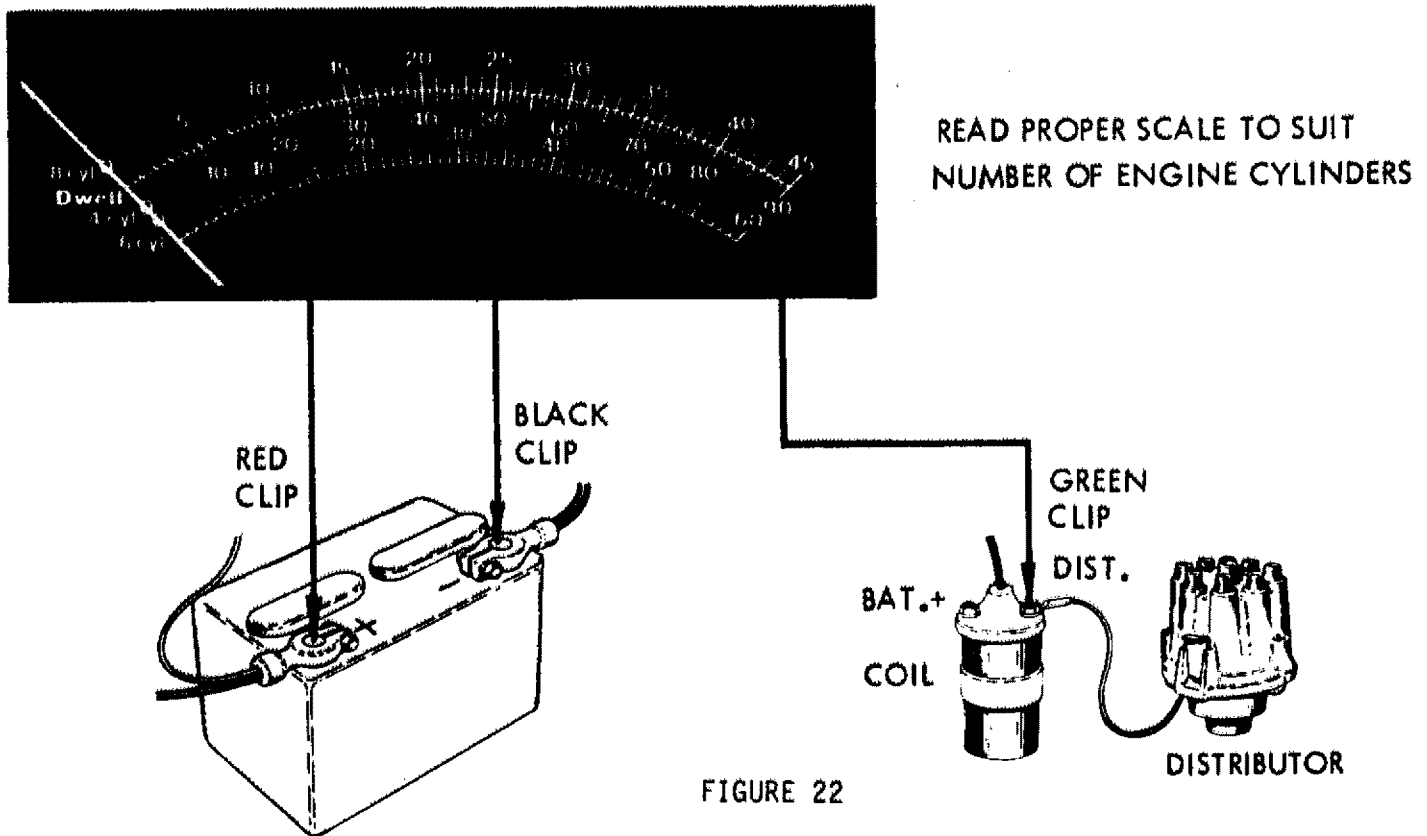

DWELL ADJUSTMENT CONNECTIONS

On engines that have a sliding window in the distributor cap, adjust dwell as follows:

1. Operate engine at specified idle.
2. Raise the window and insert a 1/8" Allen wrench into the adjustment screw.
3. Turn the adjustment screw until the correct dwell is indicated on the dwell scale.

NOTE: Disconnect and plug the vacuum advance line from the distributor. If the vehicle is equipped with an advance-retard solenoid, disconnect the wire at the carburetor end.

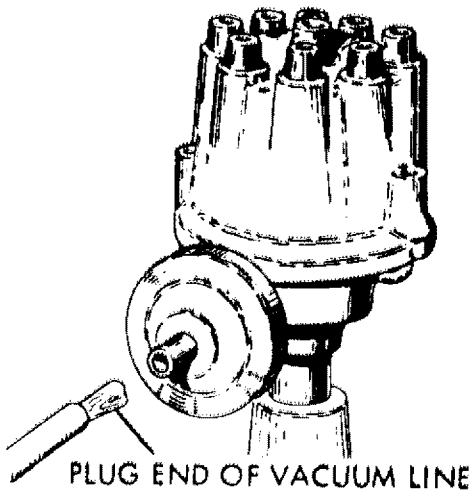

FIGURE 23

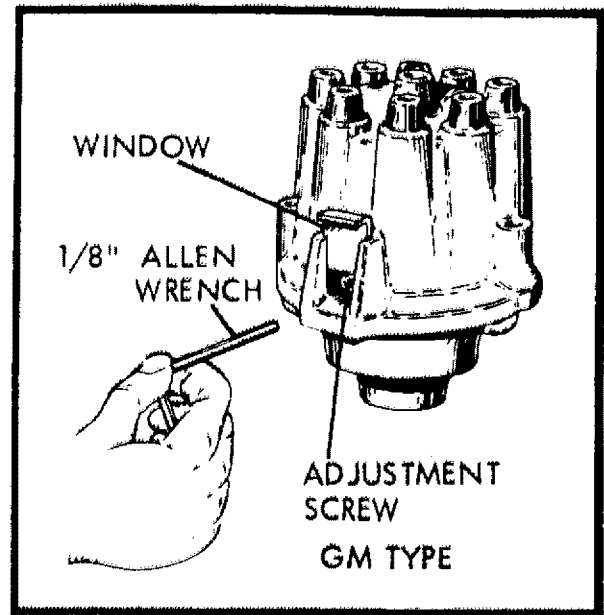

FIGURE 24

On engines with non-window distributors, adjust the dwell as follows:

1. Stop the engine and remove coil wire from the center tower of distributor cap. Connect the jumper wire between coil wire and engine ground to prevent arcing while cranking the engine.
2. Remove the distributor cap and rotor.
3. Connect a remote starter switch to the vehicle or have an assistant crank the engine for you with the ignition switch.
4. Turn the ignition switch on and with the engine cranking, observe the reading on the dwell scale.
5. To adjust dwell, loosen LOCKING screw slightly and adjust point gap by turning ADJUSTMENT screw (Figure 25) or by inserting a screwdriver in slotted hole (Figure 26) and turning the tool slightly left or right to obtain the specified point dwell reading. Tighten locking screw and recheck dwell while cranking engine. Repeat procedure if necessary.
6. Reassemble distributor and recheck dwell reading with engine operating at specified idle.

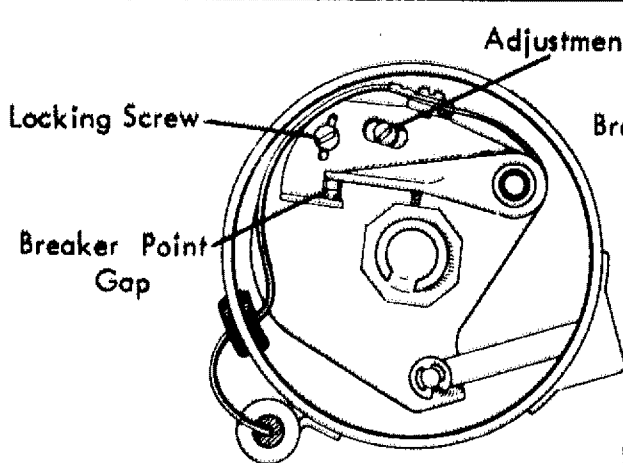

FIGURE 25

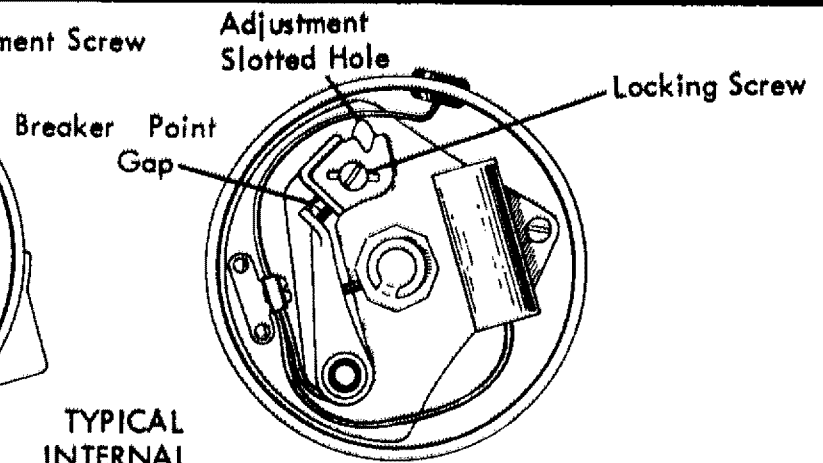

FIGURE 26

TYPICAL
INTERNAL
TYPE
BREAKER
ADJUSTMENTS

NOTE: It is important to recheck the ignition timing every time the dwell is adjusted. A one degree change in dwell causes a one degree change in timing.

THIS TEST DOES NOT APPLY TO ELECTRONIC OR TRANSISTOR IGNITION SYSTEMS EXCEPT DELCO HEI AND THOSE TYPES USING CONVENTIONAL CONTACT POINTS. ON HEI SYSTEMS, THE DWELL ANGLE WILL BE LOW AT IDLE SPEED AND WILL INCREASE STEADILY AS ENGINE SPEED INCREASES. IF IT DOES NOT, THE ENGINE MAY MISFIRE DURING ACCELERATION AND AT HIGH SPEEDS. TO CORRECT THIS CONDITION, REPLACE THE ELECTRONIC MODULE IN THE DISTRIBUTOR.

There is a direct relationship between dwell and timing. However, it is only a one way relationship. If you change the dwell angle of the breaker points, you will automatically change the timing of the ignition. Changing the timing, however, has no effect on the dwell angle. FOR THIS REASON IT IS IMPORTANT TO RE-CHECK THE TIMING WHENEVER THE DWELL ANGLE HAS BEEN ADJUSTED.

When the dwell angle is increased, the timing is retarded. Conversely, when the dwell angle is decreased, the timing is advanced. In fact, there is a one-to-one ratio between dwell and timing. For every one degree change in dwell, there is a corresponding one degree change in timing. This can sometimes be used to make minor changes in timing. If, for example, it is desired to advance the timing two degrees, it can be done by reducing the dwell angle two degrees. This assumes that the dwell angle will not be changed out of its specified range.

Due to normal wear of the rubbing block, the normal tendency is for the dwell angle to increase. This, of course, causes the timing to become retarded and results in a loss of power and economy. If the engine has been properly tuned initially, restoring the dwell angle to its original setting will restore the timing to its original setting.

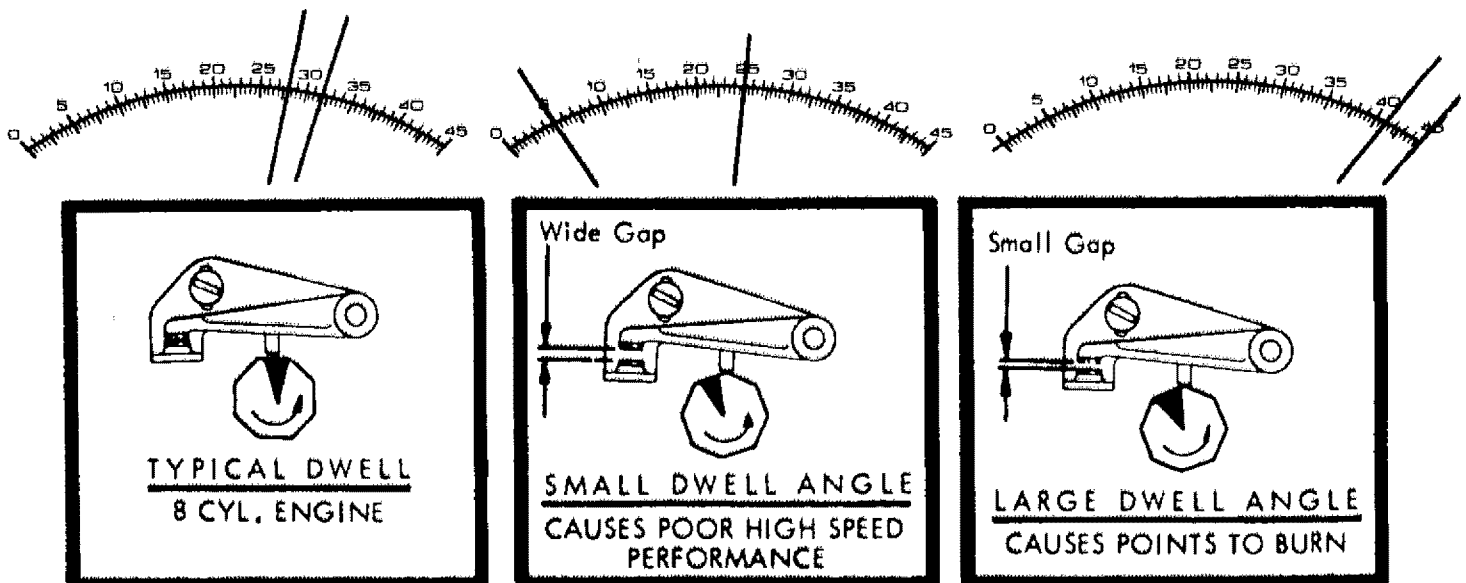

FIGURE 27

Test Number 14--Dwell Variation Test

Repeat Test Number 13, Steps 1-4

NOTE: This test does not apply to transistorized ignition systems (except those types using conventional contact points).

1. Rotate the Function Selector Switch to the DWELL position.
2. Disconnect and plug vacuum advance hose(s) as described in DWELL Angle Test 13 on page 21 and 22 .
3. Operate engine at curb idle. While observing DWELL scale for any change in reading, increase engine speed to approximately 1500 RPM and then return to idle.
4. Reconnect vacuum advance hose(s).

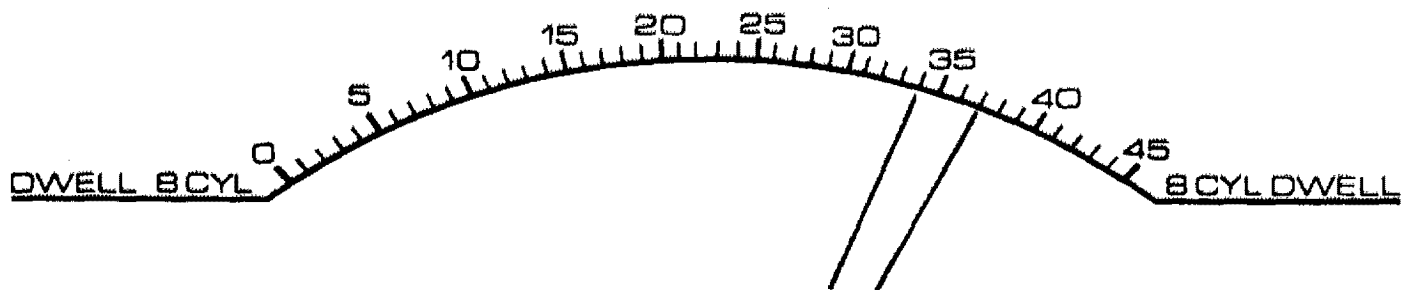

FIGURE 28

DWELL VARIATION

Variation on 4, 6, and 8-cylinder engines should not exceed 3 degrees. If it does, check for:

- a. wear in distributor shaft
- b. wear in distributor shaft bushing
- c. wear in breaker plate

NOTE: Manufacturer's specifications for some engines call for the distributor vacuum advance hose to remain connected during the Dwell Variation Test. In this case, a maximum dwell variation of 6 degrees is allowed unless otherwise specified by the manufacturer.

Test Number 15--Dwell Angle--Electronic Ignition Systems

(Electronic Solid State or Transistor Ignition Systems)

General--

Due to the vast array of electronic ignition and engine control systems being used on late model cars, it is essential that specific service information for the vehicle under test be obtained. Although Dwell Angle is not adjustable on electronic systems, the reading obtained is important and should be within the manufacturer's specified limits. If it is not, consult the manufacturer's shop manuals for diagnostic procedures.

Preparation for tests--

Before beginning tests, always check the zero adjustment of the instrument as outlined under Description--Zero Adjuster, above. Attach the test leads to the instrument and proceed to the section in this manual describing, CONNECTIONS FOR TESTING the appropriate vehicle.

CONNECTIONS FOR TESTING

Ford--

On Ford cars with 1974 electronic ignition systems, use the Ford adapter pin as shown in Figure 29, below. Connect the GREEN clip from the Craftsman Engine Analyzer to the adapter pin. Connect the RED clip to the positive battery terminal and the BLACK clip to a clean and secure ground such as the engine block.

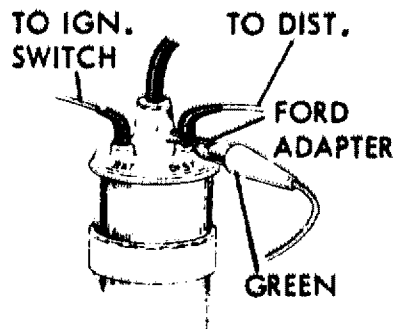

FIGURE 29

DWELL CONNECTION TO
1974 FORD ELECTRONIC
IGNITION SYSTEM

On Ford cars with insulated coil terminals, lift the distributor terminal and slide the Ford Adapter clip in place as shown, then push the terminal down on it. Remove when the tests are finished.

On 1975 and later Ford electronic ignition systems, connect the GREEN clip from the Craftsman Engine Analyzer to the wire terminal on the TACH side of the coil as shown in FIGURE 30, below.

Connect the RED clip to the positive battery terminal and the BLACK clip to a clean and secure ground such as the engine block.

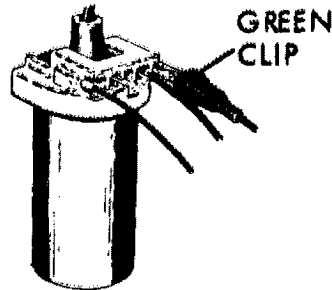

DWELL CONNECTION TO
1975 AND LATER FORD
ELECTRONIC IGNITION
SYSTEMS

FIGURE 30

On General Motors cars equipped with an ENGINE ELECTRICAL DIAGNOSTIC CONNECTOR (usually located under the hood near the left front fender wheel well), open the hinged cover and insert the spade terminal adapter in socket number 6, as shown in Figure 31, below. Connect the GREEN clip from the Craftsman Engine Analyzer to the spade terminal adapter just installed. Connect the RED clip to the positive battery terminal and the BLACK clip to a clean and secure ground such as the engine block.

NOTE: Experience has shown that this is the easiest way to make a dwell connection to GM vehicles. Only if your vehicle does not have an ENGINE ELECTRICAL DIAGNOSTIC CONNECTOR should you use one of the two (2) connection procedures to follow.

CAUTION: Do not confuse the ENGINE ELECTRICAL DIAGNOSTIC CONNECTOR with the HEATER/AIR CONDITIONING DIAGNOSTIC CONNECTOR located on the passenger side of the vehicle near the air conditioning system.

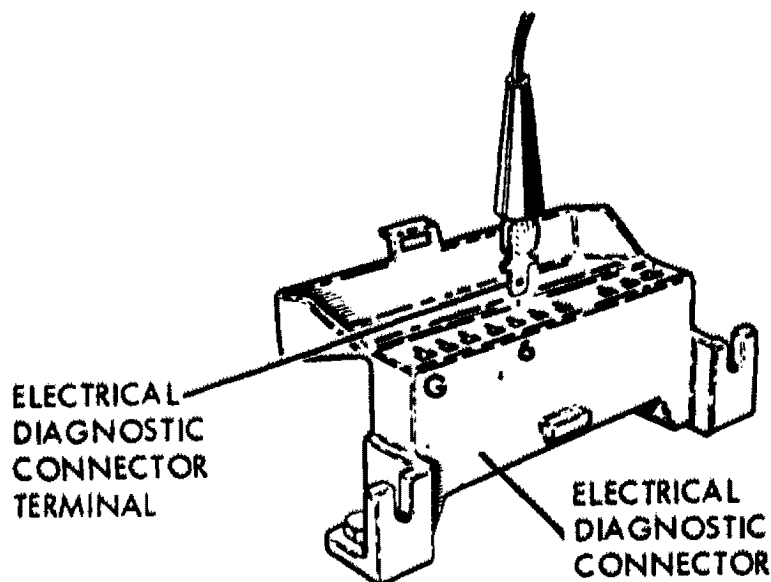

DWELL CONNECTION TO
GENERAL MOTORS CARS
WITH DELCO HEI AND
DIAGNOSTIC CONNECTOR.

FIGURE 31

General Motors--

On General Motors cars with 4-cylinder and in-line 6-cylinder engines and separate ignition coil, connect the GREEN clip from the Craftsman Engine Analyzer to the open TACH terminal as shown in FIGURE 32, below. Connect the RED clip to the positive battery terminal and the BLACK clip to a clean and secure ground, such as the engine block.

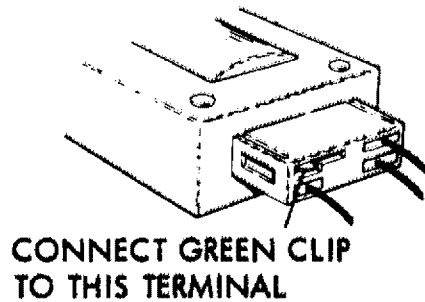

DWELL CONNECTION
TO GENERAL MOTORS
CARS WITH SEPARATE
IGNITION COIL

FIGURE 32

On the General Motors integral ignition coil, V-8 and V-6 HEI systems, slide the adapter onto the TACH terminal as shown in Figure 33 below. Connect the GREEN clip from the Craftsman Engine Analyzer to the adapter just installed. Connect the RED clip to the positive battery terminal and the BLACK clip to a clean and secure ground such as the engine block.

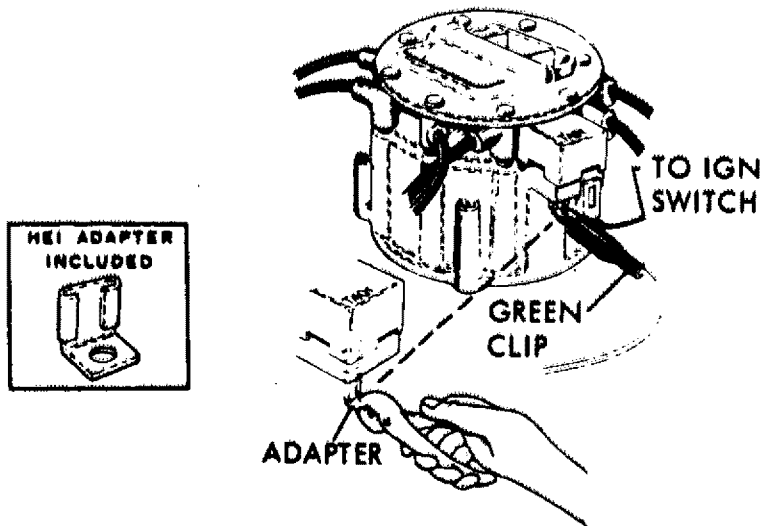

DWELL CONNECTION
TO GENERAL MOTORS
CARS WITH DELCO
HEI IGNITION SYSTEMS

FIGURE 33

Ford / Chrysler / American Motors

1. Connect the test leads from the Craftsman Engine Analyzer as shown in Figure 29 or 30 as appropriate to the vehicle under test. Keep the leads clear of fan, belts, and pulleys.
2. Set the Function Selector Switch to the DWELL position.
3. Start the engine and let it warm to curb idle speed (check manufacturer's recommendations).
4. Read the appropriate 4, 6, or 8 cylinder DWELL scale, depending upon the engine type.
5. The DWELL reading obtained should meet the manufacturer's specification for that engine. If it does not, consult the manufacturer's shop manuals for diagnostic procedures.

General Motors

1. Connect the test leads from the Craftsman Engine Analyzer as shown in Figure 31, 32, or 33 as appropriate to the vehicle under test. Keep the leads clear of fan, belts, and pulleys.
2. Continue with steps 2 through 5 as described under Ford / Chrysler / American Motors, above.
3. On HEI systems, the indicated DWELL Angle will normally be low at idle speed and will increase steadily as engine speed increases. If it does not, consult the manufacturer's shop manuals for diagnostic procedures.

Test Number 16--Initial Ignition Timing

This test should be made following any dwell adjustments as the point setting controls the basic ignition timing. On electronic ignition systems refer to the vehicle service manual for special instructions. Spark timing controls are used to advance or retard timing. Follow manufacturer's service procedures to check & adjust timing properly.

1. Connect a timing light to the battery and #1 spark plug cable as illustrated below, in Figure 38.
2. Rotate the Function Selector Switch to the RPM position and set the RPM range selector to the Lo-1200 RPM position for idle speeds and the Hi-6000 RPM for the high speed tests.
3. Locate the timing mark on the fly wheel and degree indicator plate. Clean both surfaces and apply a white chalkmark on the fly wheel mark for good visibility. (Figure 35)
4. Consult your vehicle service manual or tune-up decal under the hood to determine which, if any vacuum hoses must be removed for proper timing adjustment. Make sure to follow all timing instructions pertaining to your vehicle. The above illustration shows the vacuum advance hose disconnected and plugged. (Figure 37)
5. Close starter shunt, start the engine and operate at specified engine speed. Refer to vehicle tune up specifications label under the hood for proper RPM.
6. Operate timing light and aim it at the timing mark. Note the position of the fly wheel mark in relation to the degree indicator. Compare to specified initial timing. If not within specifications, readjust distributor as required.
7. TIMING ADJUSTMENT. To change timing, loosen the distributor hold down screw or bolt and rotate the distributor body as shown in Figures 36 and 37. until proper timing is indicated.

Test Number 17--Timing Advance Systems

NOTE: The following centrifugal and vacuum advance tests are general ones and may not apply to many of the more modern vehicles. Many of today's vehicles have complex emission and ignition control systems which may alter or prevent spark advance from taking place under various conditions. It is therefore very important to consult your vehicle service manual for the proper procedures to check and/or repair advance systems.

A. Mechanical

CENTRIFUGAL ADVANCE. With the distributor vacuum hose disconnected and plugged, operate the engine at specified idle speed and note position of timing mark. INCREASE engine RPM slowly and observe movement of timing mark. The mark should move steadily and without jerking in the opposite direction to fly wheel rotation, up to approximately 1800 RPM. Decrease speed and mark should return smoothly to its original position.

VACUUM ADVANCE TEST. Operate the engine at 1500 RPM and connect the vacuum advance hose to the distributor vacuum control and observe movement of the timing mark. The mark should move opposite to fly wheel rotation and may appear beyond the range of the degree indicator with a normal operating vacuum control.

BATTERY POST ADAPTER CONNECTIONS FOR STARTING ENGINE

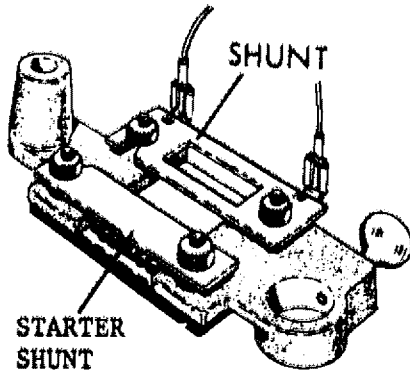

FIGURE 34

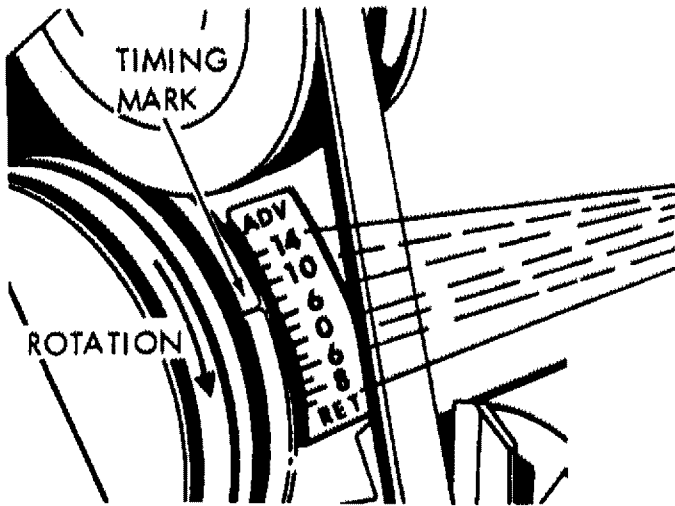

FIGURE 35

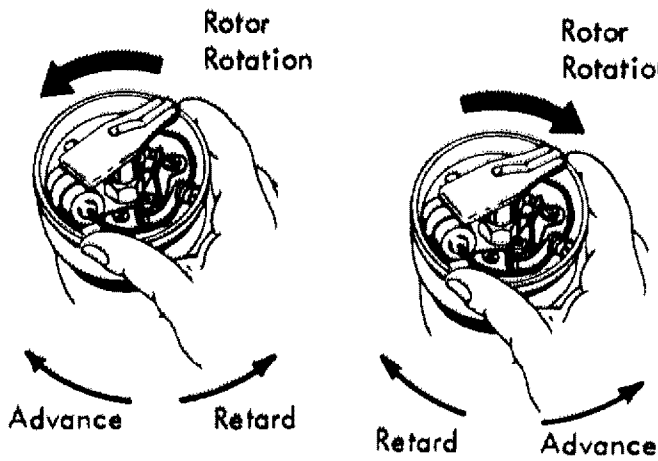
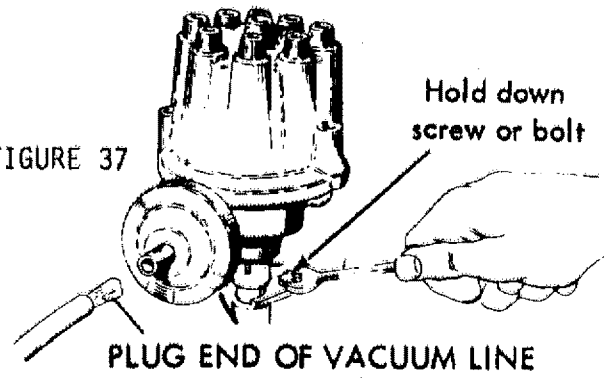
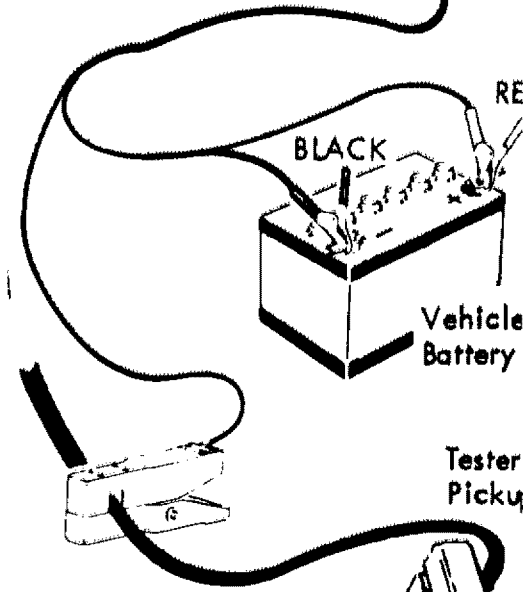
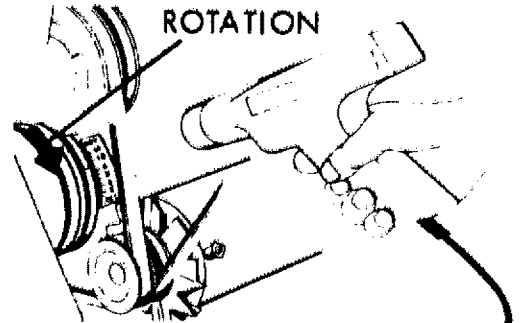

FIGURE 36

FIGURE 37



PLUG END OF VACUUM LINE



SEE PAGES 6 AND 7 FOR PROPER HOOK-UP FOR RPM

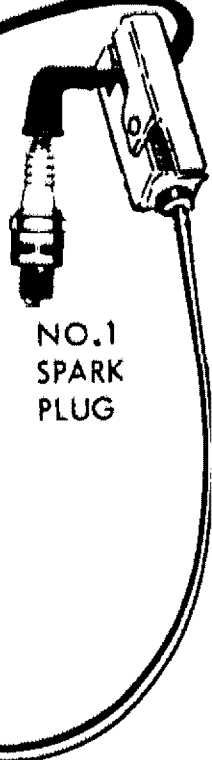
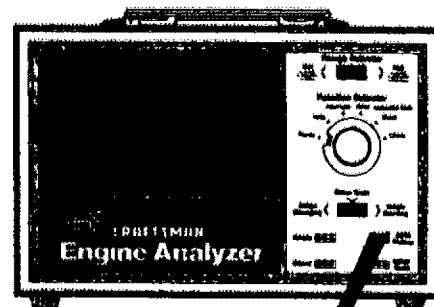
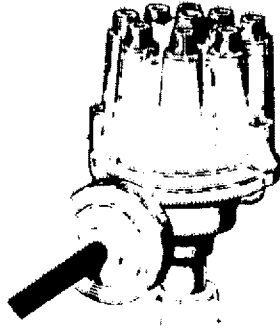

FIGURE 38



RECONNECT FOR VACUUM
ADVANCE TEST

FIGURE 39

B. Electronic

Many of today's modern vehicles use sophisticated computer controlled spark advance systems. Your Craftsman Analyzer, a top quality timing light such as the Sears 213400 Timing Light or 219400 Advance Timing Light, and the vehicle service manual are essential tools for accurately checking these complex advance systems.

IMPORTANT: DO NOT ATTEMPT TO SERVICE THESE ELECTRONIC ENGINE SYSTEMS WITHOUT THE VEHICLE SERVICE MANUAL.

Some of the Systems currently in use are:

Chrysler Corporation

ELB (Electronic Lean Burn) introduced in 1976, Re-named ESA (Electronic Spark Advance) in 1979.

Ford Motor Company:

EEC I, EEC II, EEC III, (Electronic Engine Control) introduced in 1977.

General Motors:

ESS (Electronic Spark Selection) introduced in 1977.

EST (Electronic Spark Timing)

ESC (Electronic Spark Control)

C-4 (Computer Controlled Catalytic Converter)

C-3 (Computer Command Control)

Test Number 18--Carburetor Adjustment--Mixture (Air/Fuel Ratio)

1. Rotate the Function Selector Switch to the RPM position. Slide the Range switch to the LO-1200 RPM position for idle speed tests.
2. EMISSION CONTROL SYSTEMS. Carburetors on late-model vehicles usually have sealing caps on idle mixture screws which prohibit or restrict carburetor adjustment. These are factory calibration seals. Refer to vehicle manufacturer's service manual for mixture screw adjustment procedures.
3. IDLE MIXTURE ADJUSTMENT. It is advisable whenever possible to use the mixture adjustment procedure as outlined in the manufacturer's service manual. The following procedure should work well, however, on those vehicles without emission control systems. Turn the idle mixture screw in (lean) until the idle RPM starts to decrease and the engine begins to idle roughly. When this point is reached slowly back the idle mixture screw out (rich) until the maximum steady RPM is obtained. When making any mixture adjustment only turn the mixture screw 1/8 of a turn at a time. Between adjustments allow about 30 seconds for the engine speed to stabilize. (Figure 40)
4. MULTI-BARREL CARBURETORS. Repeat procedure described in Test Number 3 on EACH mixture screw until the smoothest maximum RPM is obtained. Turn each screw 1/8 of a turn at a time to prevent engine stalling. If the final idle RPM is now higher than specified, readjust mixture screws again until no further increase is possible. (Figure 41)
5. NOTE: On vehicles with emission control systems, air injection pumps and positive crankcase ventilation, refer to vehicle tune-up decal in the engine compartment for idle adjustment procedures.

IMPORTANT! Air/Fuel mixture adjustment is one of the more critical adjustments on the engine. Fuel economy and Emission Control can be diminished through incorrect settings or adjustment. Carefully follow the vehicle manufacturer's instructions when adjusting carburetor idle mixture.

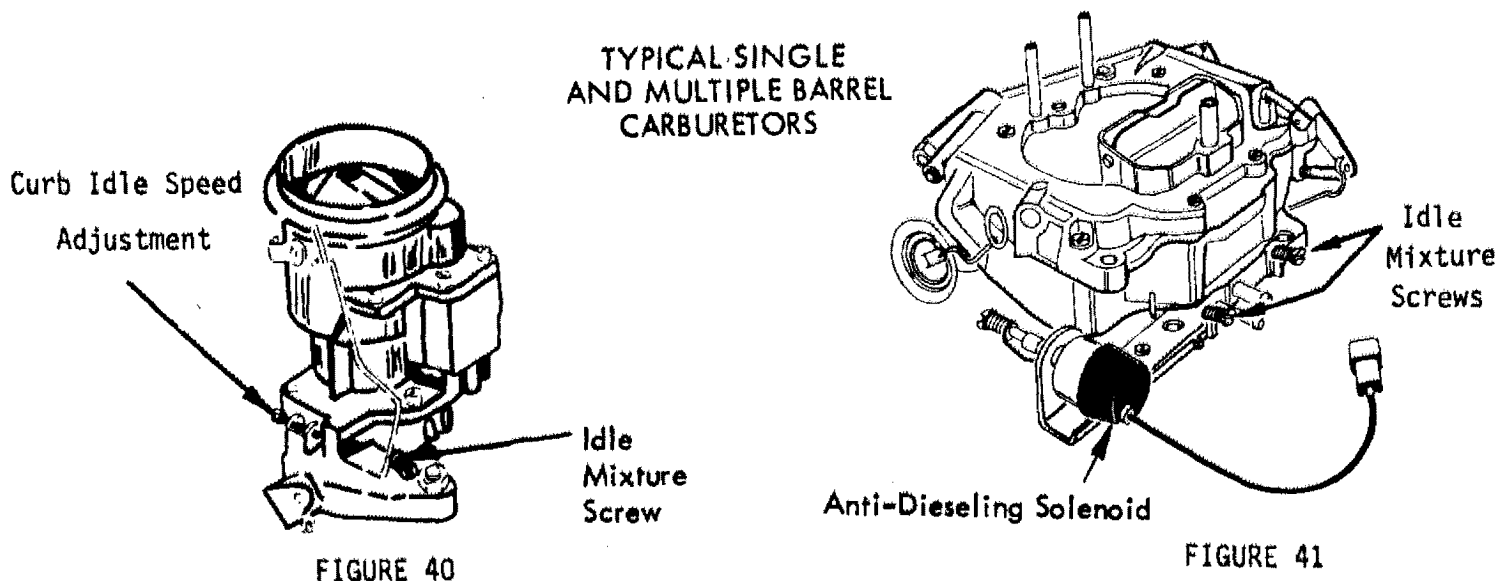

Test Number 19--Carburetor Adjustment--Curb Idle Speed

1. Rotate the Function Selector Switch to the RPM position. Slide the Range Switch to the LO-1200 RPM position for idle speed tests.
2. IDLE SPEED ADJUSTMENT. Engine must be at normal operating temperature before setting curb idle. Refer to vehicle specifications for idle RPM range. Check for variations in curb idle with air conditioner on, and any other specified idle range requirements.

Curb idle speed can be affected by other engine adjustments such as timing, air/fuel ratio, and emission control operation. Carefully follow manufacturer's instructions when adjusting curb idle. Be certain to recheck it after making any other engine adjustments.

Test Number 20--Throttle Kicking Solenoids

- A. Anti-Dieseling Solenoid Adjustment
The purpose of this device is to prevent engine run-on (dieseling) after the key is turned off. Basic operation of this solenoid is as follows: When the ignition key is in the run position, voltage is applied to the solenoid, energizing it and causing it to move the idle position of the throttle. Curb idle is adjusted with the solenoid energized. When the key is turned off the solenoid retracts and allows the throttle-plates to close or return to a base idle, hence, shutting off the fuel/air supply to the engine. By using the RPM, VOLTS, and OHMMETER sections of your Craftsman Analyzer and specific tests described in your vehicle service manual, you will be able to diagnose faults and properly adjust the anti-dieseling solenoid.
- B. Air-Conditioning Solenoid Adjustment
The purpose of the Air Conditioning solenoid is to maintain proper engine idle speed with the vehicle's air conditioner running. It is energized by the same circuit as the Air-Conditioning clutch and when energized "kicks" the throttle enough to bring the idle to its intended curb idle speed. By using the RPM, VOLTS, and OHMMETER sections of your Craftsman Analyzer and specific tests described in your vehicle service manual, you will be able to diagnose faults and properly adjust the air-conditioning solenoid.

Test Number 21 and 22--Fast Idle and Automatic Choke Adjustment

The purpose of the fast idle function is to maintain proper engine speed during cold engine and warm-up operation. Additional throttle opening is needed with the automatic choke butterfly valve in a closed or partially closed position to keep the engine running smoothly and prevent stalling. The choking action provides a richer fuel-air mixture during cold engine operation to compensate for poor fuel atomization. The increased idle speed warms up the engine quickly which enhances fuel-air atomization and mixing.

The fast idle adjustment screw seats on a cam which is thermostatically controlled through the choke linkage. As the engine warms, the choke opens, the fast idle cam drops to progressively lower steps and the fast idle speed gradually approaches curb-idle. On a fully-warmed engine, the fast idle cam releases the fast idle adjustment screw completely. Engine idle speed is then controlled by the curb idle adjustment screw.

Fast idle adjustment procedures differ among the various automobiles. Consult your specific vehicle service manual for proper procedures. It may be necessary to bypass one or more spark timing or emissions system controls, either vacuum or electric, while adjusting the fast idle.

Many late model vehicles use a full electric or an electrically assisted choke. It contains a small electric heater which activates a bimetallic coil spring or belleville washer to reduce the choke time under certain conditions. This heater may be controlled by a temperature switch located either in the choke housing or elsewhere on the engine.

The Ohmmeter Function can be used to confirm switch continuity, heater element resistance and related wiring. The Voltmeter function is used to confirm the presence of voltage to and within the choke system as directed by your vehicle service manual. Use the RPM function to set fast idle per manufacturer's instructions.

Test Number 23--Ignition Coil

Refer to Test Number 9--Ohms Test (sections 1-7) for Ohmmeter use.

IGNITION COIL PRIMARY RESISTANCE TEST

1. Set the Range Slide Switch to the OHMS X 1 position.
2. Remove the primary wires from both coil terminals.
3. Connect the RED and BLACK test leads to primary coil terminals, as illustrated in Figure 42.
4. Observe reading on the Low Ohms scale, then re-connect primary wires.

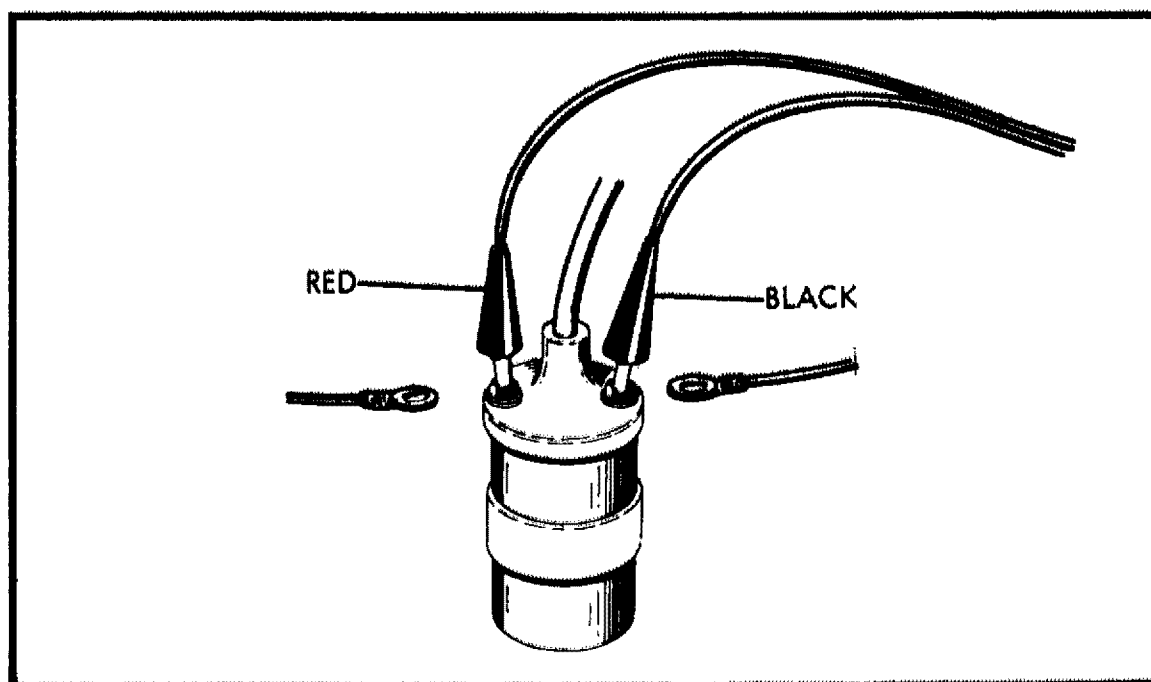

FIGURE 42
PRIMARY RESISTANCE

TEST CONNECTIONS

- A. The reading should meet the vehicle manufacturer's specifications. Generally, the coil primary winding resistance should be between 1 and 2 ohms. Check your vehicle service manual for the exact value.
- B. If the reading is substantially above or below the manufacturer's specifications, the ignition coil is defective and should be replaced.

COIL SECONDARY RESISTANCE ON OHMS X 1000 POSITION

FIGURE 43

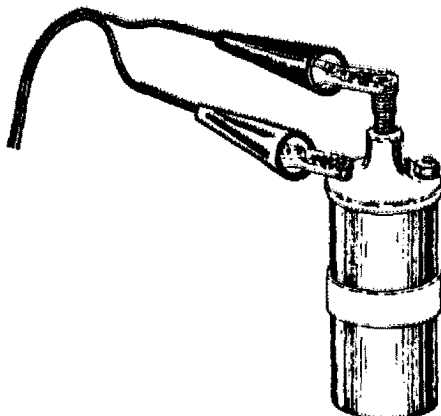

1. Remove the high tension lead from the coil tower. Be sure the ignition switch is OFF.
2. Connect one of the OHMMETER test leads to either coil screw terminal. (On late model Ford cars, use the Ford Adapter as illustrated on page 25.) Connect the other lead to a spark plug adapter and insert in the coil tower as shown.
3. Read the Ohms X 1000 scale on the meter and compare the reading with the manufacturer's specification in the next column.

TEST RESULTS

The resistance of most coils for standard ignition systems are given in the table below.

<u>MANUFACTURER</u>	<u>SECONDARY RESISTANCE (OHMS)</u>
American Motors	6,500 to 9,500
Chrysler	9,500 to 11,500
Ford	7,500 to 9,000
G. M. Delco Remy	5,500 to 9,500

If the reading is higher or lower than the manufacturer's specification, the coil should be replaced.

Test Number 24--Ignition Cables

Refer to Test Number 9--Ohms Test (sections 1-7) for Ohmmeter use.

IGNITION CABLE TEST

Standard ignition cable is NOT solid wire. It is a graphite impregnated fibre conductor with a built-in resistance of 1000 to 50,000 ohms, depending upon the length of the cable and the type of engine. This resistance is necessary to suppress spark interference with radio, television, and other communication reception. It also contributes to longer distributor cap and spark plug electrode life. If the resistance value of the cable is significantly increased by stretching or breaking the internal graphite impregnated conductor, the engine will misfire and its overall performance will deteriorate.

1. Remove the cables from the engine. When removing the wire from the spark plug, grasp the spark plug boot and twist and pull wire with a firm, steady force. DO NOT yank on the cable to remove it.
2. Use the X 1000 position on the RANGE SELECTOR of the Craftsman Analyzer.
3. Connect the RED and BLACK Ohmmeter test leads to the ends of the cable as shown below, and use an adaptor spring at the SPARK PLUG END of the cable as shown.(Figure 44)
4. Gently flex the ignition cable while testing. If the OHMMETER reading wanders excessively or rises to infinity (∞) the cable is defective and should be replaced.
5. Consult your vehicle service manual for the proper resistance range per inch or foot of cable. Replace those wires which are out of tolerance.

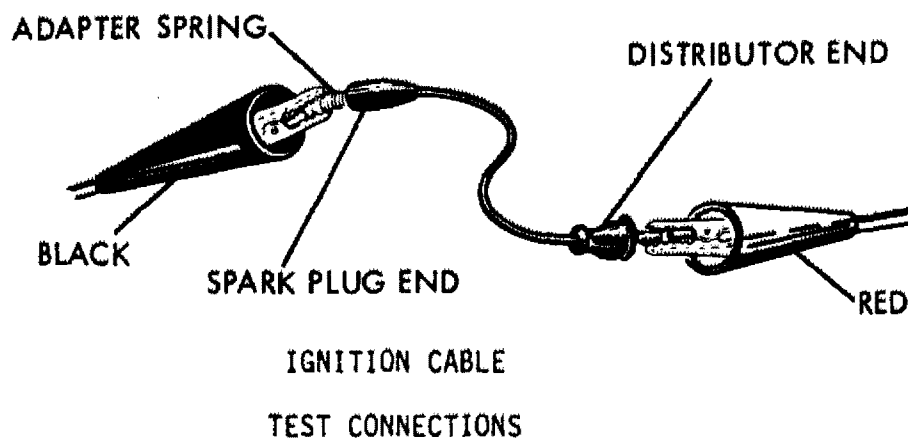

FIGURE 44

Test Number 25--Ballast Resistor

Refer to Test Number 9--Ohms Test (sections 1-7) for Ohmmeter use.

The purpose of the ballast resistor (when equipped) is to limit the current available to the ignition coil when the vehicle is running. Failure of this resistor results in a dead engine. If the engine tries to start when cranking, but the instant you release the key, it stops, then you may have an "open" ballast resistor. You can feel and hear the engine cranking speed increase because the ignition system is trying to take over. With the ignition key off, locate the ballast resistor and remove the wires that are connected to it. (The ballast resistor is usually a white ceramic block with brass terminals and is generally located on the fire wall. If you have difficulty locating it, consult your vehicle service manual.)

NOTE: Many Chrysler Corporation Electronic Ignition Systems use a dual ballast resistor. One side of this resistor functions exactly as indicated above. The other side is the auxiliary ballast resistor and it should read approximately 5 ohms. (Figure 45)

PROCEDURE

The OHMS scale is used to test the ballast resistor. To test the ballast resistor, disconnect all leads at their terminals to prevent possible damage to the analyzer or to prevent inadvertent measurement of other circuits connected to it.

CONNECTIONS:

1. Insert the white plug OHMS lead into the corresponding tester socket.
2. Connect the RED and BLACK clips to the ballast resistor as shown. Some ballast resistors are dual units--such as on some Chrysler automobiles, while others are single units--or resistor wires. Some ignition systems utilize the ballast resistor in the coil primary (see ignition coil test).

TEST PROCEDURE:

1. The Ohmmeter will read full scale at the extreme right hand side, INFINITY (∞), with the BLACK and RED clips disconnected. When the clips are connected together, the meter pointer will read zero on the left (short circuit or zero ohms).
2. To measure the ballast resistor, connect the RED and BLACK clips as shown in Figure 45 . Set the Function Selector Switch to the OHMS position.
3. Set the Range Selector Switch to the LOW scale. Typical readings should be between 0.5 and 7.5 ohms.

IMPORTANT: Consult your vehicle service manual for the exact OHMS value for your car. The value read should be very close to the specified value as large differences can cause damaged points or electronic ignition module (when too low).

4. If the meter reads ∞ , (right hand side of the scale) the ballast resistor is open and must be replaced.

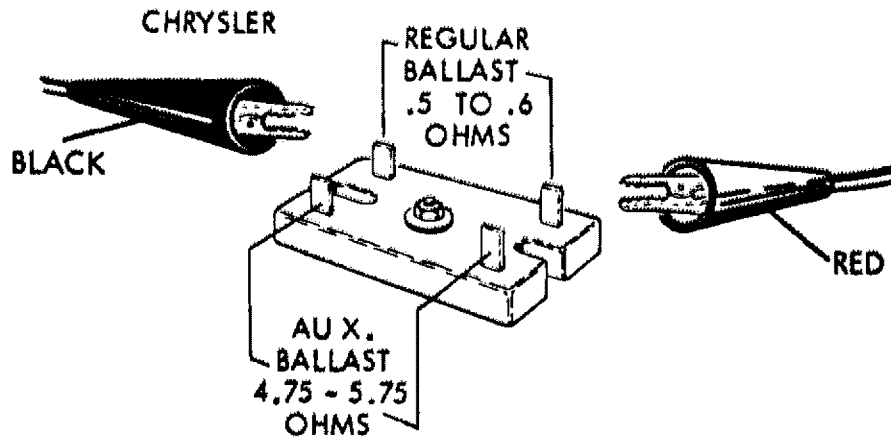

BALLAST RESISTOR TEST CONNECTIONS

FIGURE 45

Test Number 26--Ignition Switch

The ignition switch performs many duties beyond starting the vehicle. With the guidance of your vehicle service manual, your Craftsman Voltmeter and/or Ohmmeter can confirm operation of the ignition switch.

Some of the ignition switch functions are as follows:

1. Activate starter relay (start position)
2. Bypass ignition ballast resistor (start position)
3. Confirm tell-tale cluster lights (start position)
4. Activate ignition
5. Activate accessories

If you have difficulty with any of the above circuits, the ignition switch is a possible source of trouble. Consult your vehicle service manual for exact diagnostic procedures.

ELECTRONIC IGNITION SYSTEMS

The following ten pages are devoted to the four basic Electronic Ignition Systems as used by American Motors, Chrysler Corporation, Ford Motor Company, and General Motors.

The diagrams and charts will step you through point-to-point testing of the various components within each system. You will use the VOLTS, OHMS and POINTS-LOW VOLTS positions of your analyzer. It would be advisable before beginning these tests to review the use of the VOLTS, OHMS, and POINTS positions of your analyzer as shown earlier in this manual.

American Motors 1975-76
American Motors 1977 & Up See Ford Motor Co.
Chrysler Corporation
Ford Motor Company
General Motors (Integral Coil)
General Motors (External Coil)

Test Number 27--American Motors Electronic Ignition System

Test Number 28--Chrysler Electronic Ignition System

Test Number 29--Ford Electronic Ignition System

Test Number 30--Delco HEI Ignition

Test Number 31--Delco HEI Ignition System With Separate Coil

GENERAL MOTORS HIGH ENERGY IGNITION — DISABLING PROCEDURES

When performing Charging System tests on General Motors vehicles equipped with High Energy Ignition (HEI), the engine can be prevented from starting as follows:

SYSTEMS WITH COIL IN DISTRIBUTOR CAP

Disconnect primary wire from the BAT terminal on the distributor cap.

CAUTION: The tachometer terminal must NEVER be connected to ground at the distributor cap, as damage to the distributor module can result.

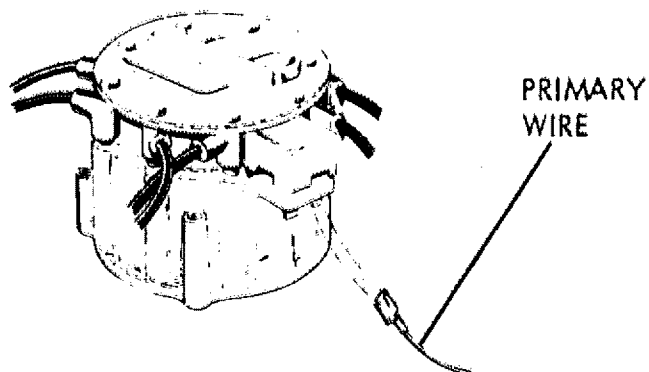

SYSTEMS WITH SEPARATE COIL

Remove high-tension coil wire from coil secondary terminal. Connect Jumper Wire between coil secondary terminal and a good ground on the engine.

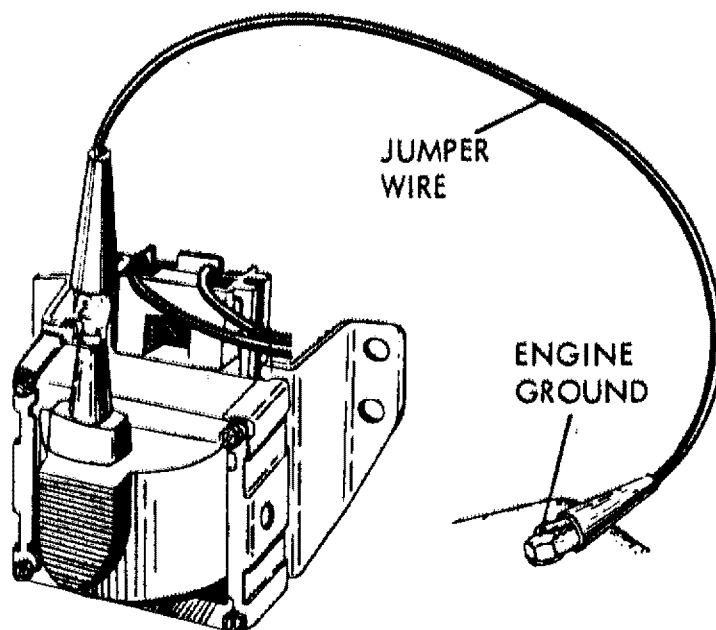

HEI WITH ELECTRICAL DIAGNOSTIC CONNECTOR

Insert the GM Diagnostic Connector Terminal in terminal No. 6 of Electrical Diagnostic Connector. Connect jumper wire between this terminal and a good ground.

CAUTION: The tachometer terminal must NEVER be connected to ground at the distributor cap, as damage to the distributor module can result.

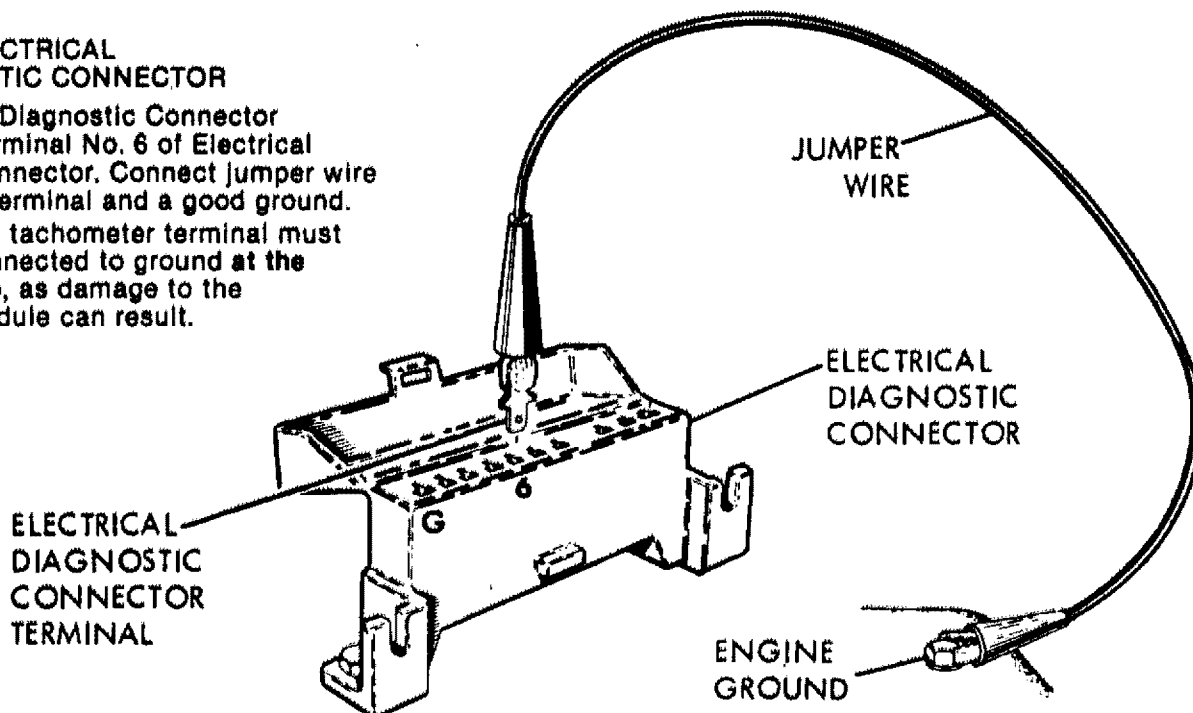

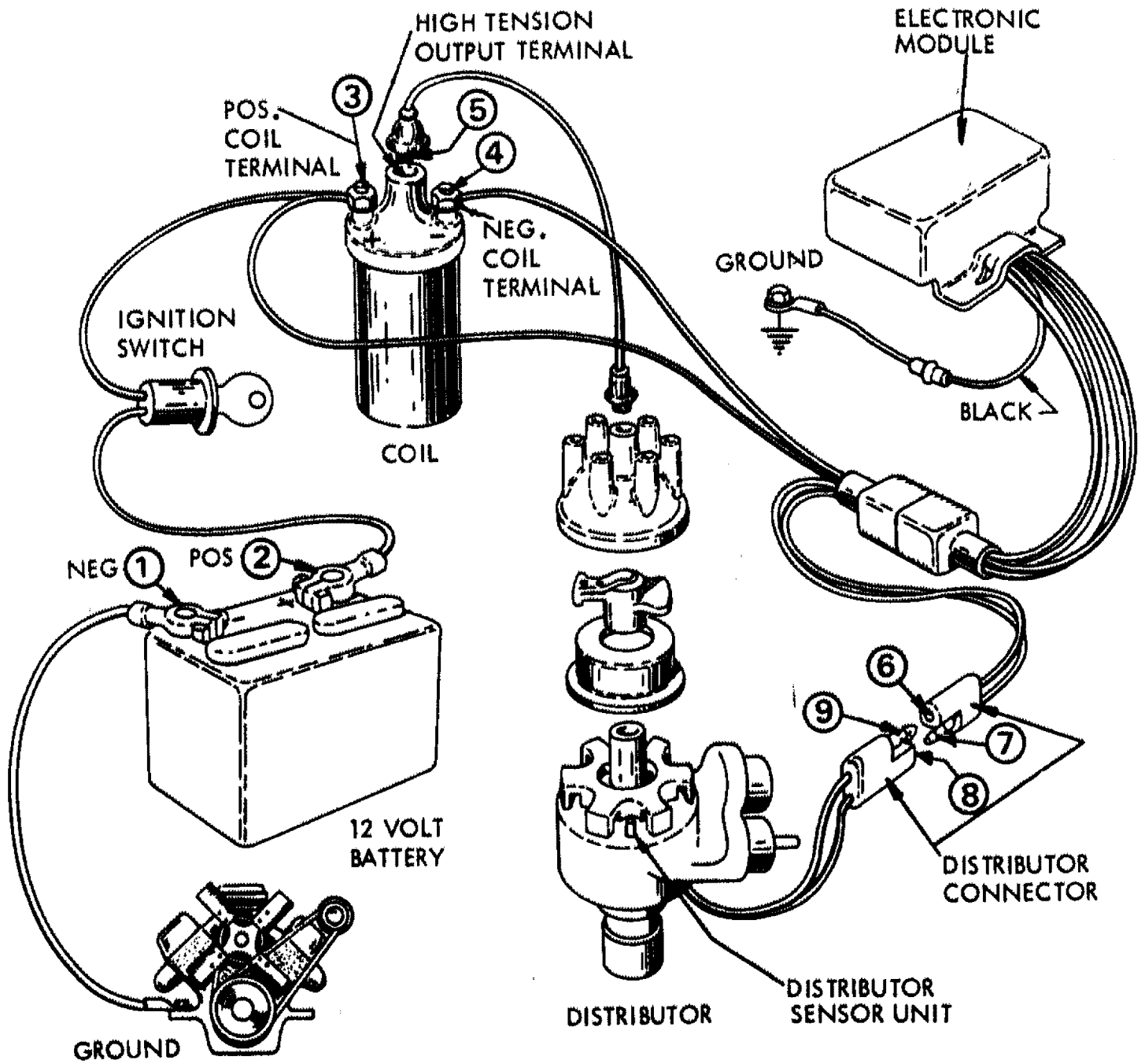

FIGURE 46

AMERICAN MOTORS ELECTRONIC IGNITION SYSTEM

Test Number 27 Continued

AMERICAN MOTORS ELECTRONIC IGNITION COMPONENTS

TEST	SELECTOR KNOB POSITION	CLIP CONNECTIONS		TEST PROCEDURE AND RESULTS
		RED	BLACK	
A Battery State of Charge	16 VOLTS	2 Battery Pos.(+)	1 Battery Neg.(-)	Remove Coil High Tension Wire from the distributor and ground it. Crank Engine. Meter should read above 9.0 volts. If not, charge battery and repeat test. Replace High Tension Wire in distributor.
B Ignition Switch	16 VOLTS	3 Coil Pos.(+) Terminal	1 Battery Neg.(-)	With Ignition Switch on, meter should read at least 10 volts. If not, inspect the switch for loose connections and faulty contacts. Replace switch if defective.
C Coil Primary and Electronic Module	16 VOLTS	4 Coil Neg.(-) Terminal	1 Battery Neg.(-)	Unplug distributor connector. With Ignition Switch on, meter should read between 5 and 8 volts. If OK proceed to Test F. If less than 5 volts or more than 8 volts, proceed with Test D.
D Coil Primary Resistance	OHMS x 1	3 Coil Pos.(+) Terminal	4 Coil Neg.(-) Terminal	With distributor connector unplugged and coil negative lead disconnected, meter should read between .7 and 2.5 ohms with Ignition Switch off. If not, replace coil.
E Coil Secondary Resistance	OHMS x 1000	3 Coil Pos.(+) Terminal	5 Coil high tension output Terminal	With Ignition Switch off, and negative (-) coil lead disconnected, connect RED clip to positive (+) coil terminal, and hold BLACK clip in coil high tension output terminal. Meter should read between 8,000 and 16,000 ohms. If not, replace coil.
F Distributor Sensor Unit Continuity	OHMS x 1	8 Distributor Connector Cavity	9 Distributor Connector Pin	Meter should read between .8 and 3.0 ohms. If not, replace Distributor Sensor Unit.
G Distributor Sensor Unit to Ground	OHMS x 1000	1 Battery Neg.(-)	9 Distributor Connector Pin	Meter should not move. If it does, replace Distributor Sensor Unit.

If tests above do not locate defective components, then the trouble is with the Electronic Control Unit. Since this unit is not serviceable, it must be replaced.

Test Number 28

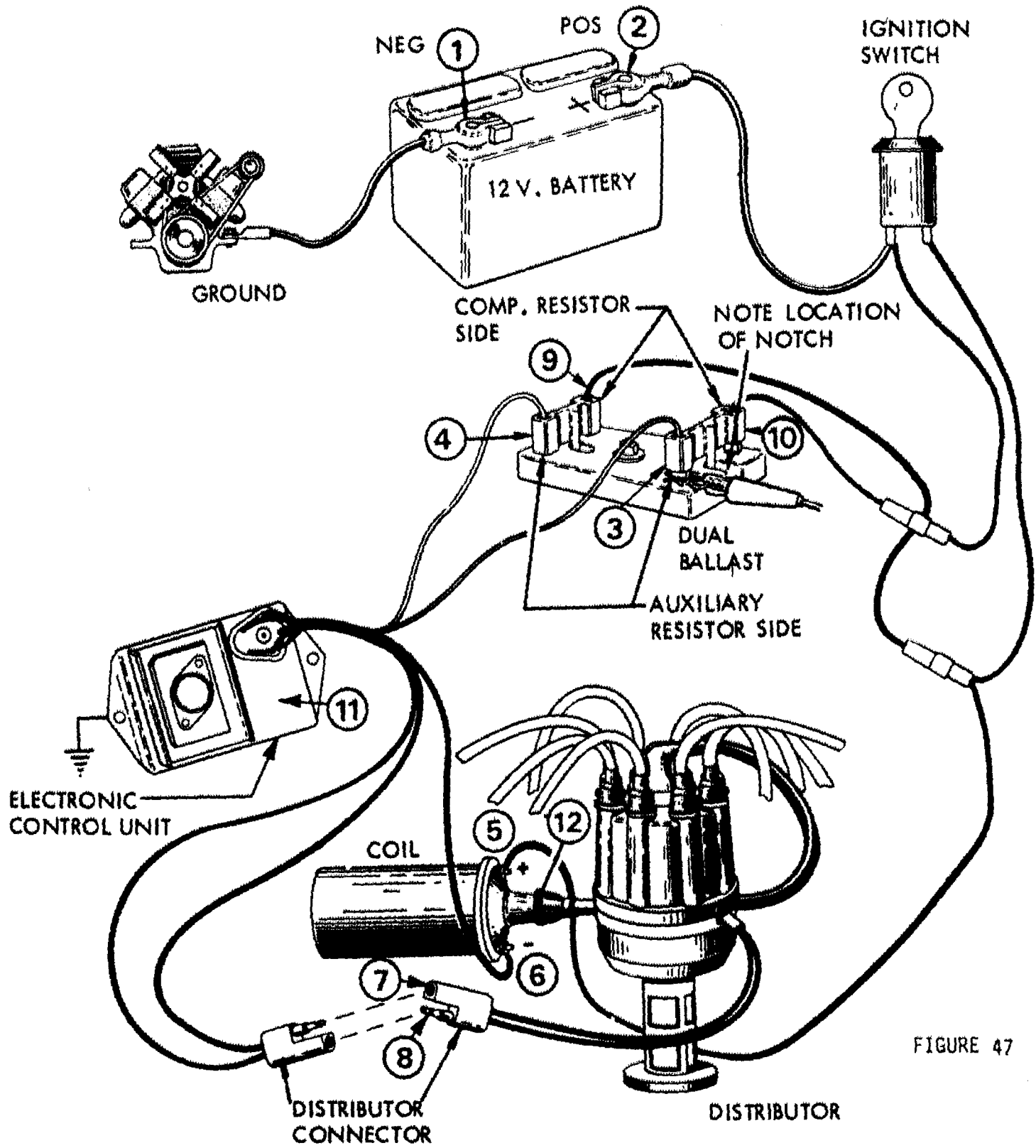

FIGURE 47

CHRYSLER ELECTRONIC IGNITION SYSTEM

CHRYSLER ELECTRONIC IGNITION COMPONENTS

TEST	SELECTOR KNOB POSITION	CLIP CONNECTIONS		TEST PROCEDURE AND RESULTS
		RED	BLACK	
A Battery State of Charge	16 VOLTS	2 Battery Pos.(+)	1 Battery Neg.(-)	Remove the High Tension Wire from the distributor and ground it. Crank Engine. The meter should read at least 9 volts while cranking. If less, charge the battery and proceed to Test B.
B Compensating Side of Ballast	16 VOLTS	5 Coil POS. Terminal	1 Battery Neg.(-)	With Ignition Switch on and engine not running, meter should read 3.5 to 7.5 volts. If less than 3.5 or zero proceed to Test E. If above 7.5 volts, proceed to Test C. If OK, crank engine. Voltage should read at least 9. If not, inspect Ignition Switch for bad connections or contacts. Replace high tension wire.
C Coil Primary and Electronic Control Unit	POINTS See Note #1	6 Coil NEG. Terminal	1 Battery Neg.(-)	With Ignition Switch on and engine not running, meter should read between 0.3 and 1.8 volts. If less than 0.3 proceed with Test D. If OK, proceed with Test F. If higher than 1.8, inspect wires and connections at Electronic Control Unit. If wires and connections OK at Electronic Control Unit, perform Test K. If test OK, replace Electronic Control Unit.
D Coil Primary	OHMS x 1	5 Coil POS. Terminal	6 Coil NEG. Terminal	With Ignition Switch off, meter should read one to three ohms. If it does not, replace Ignition Coil. If OK, proceed to E.
E Coil Secondary Continuity	OHMS x 1000	5 Coil POS. Terminal	12 Coil Tower Contact	Remove high tension lead from coil tower. Connect BLACK clip to inner contact. With Ignition off, meter should read 5,000 to 25,000 ohms. If it does not, replace coil.
F Ballast Resistance Comp. Side	OHMS x 1	9 Ballast Terminal (Comp.Side)	10 Ballast Terminal (Comp.Side)	Remove both Slip-on Terminals from Ballast and with clips connected to Terminals 9 and 10 on Ballast, meter should read 0.2 to 1.5 ohms. If it does not, replace Ballast.
G Ballast Resistance Auxiliary Side	OHMS x 1	4 Ballast Terminal (Aux. Side)	3 Ballast Terminal (Aux. Side)	Remove both Slip-on Terminals from Ballast and with clips connected to terminals 4 and 3 on Ballast, meter should read between 3 to 7 ohms. If it does not, replace Ballast, reconnect Slip-on Terminals at Ballast.
H Pick-up Coil to Ground	OHMS x 1000	8 Distributor Connector Pin	1 Battery Neg.(-)	Disconnect distributor connector. Meter should show no movement. If it does, replace Pick-up Coil. Proceed to Test J.
J Pick-up Coil Continuity	OHMS x 1000	7 Distributor Connector Cavity	8 Distributor Connector Pin	Disconnect Distributor Connector. With RED clip connected to Distributor Connector Cavity and BLACK clip connected to Distributor Connector Pin, meter should read between 150 and 900 ohms. Proceed to Test K.
K Electronic Control Unit Ground	POINTS See Note #1	11 Electronic Control Unit Case	1 Battery Neg.(-)	Scrape black paint off small section of Electronic Control Unit. With key on, touch GREEN clip to metal surface. Meter should read less than 0.25 volt. If it reads higher, turn off Ignition Switch, remove Electronic Control Unit from car mounting surface, and clean surface and Electronic Control Unit base of dirt or paint. Remount and retest.

Note #1 - Use GREEN and BLACK leads for this test only.

If tests above do not locate defective components, then the trouble is with the Electronic Control Unit. Since this unit is not serviceable, it must be replaced.

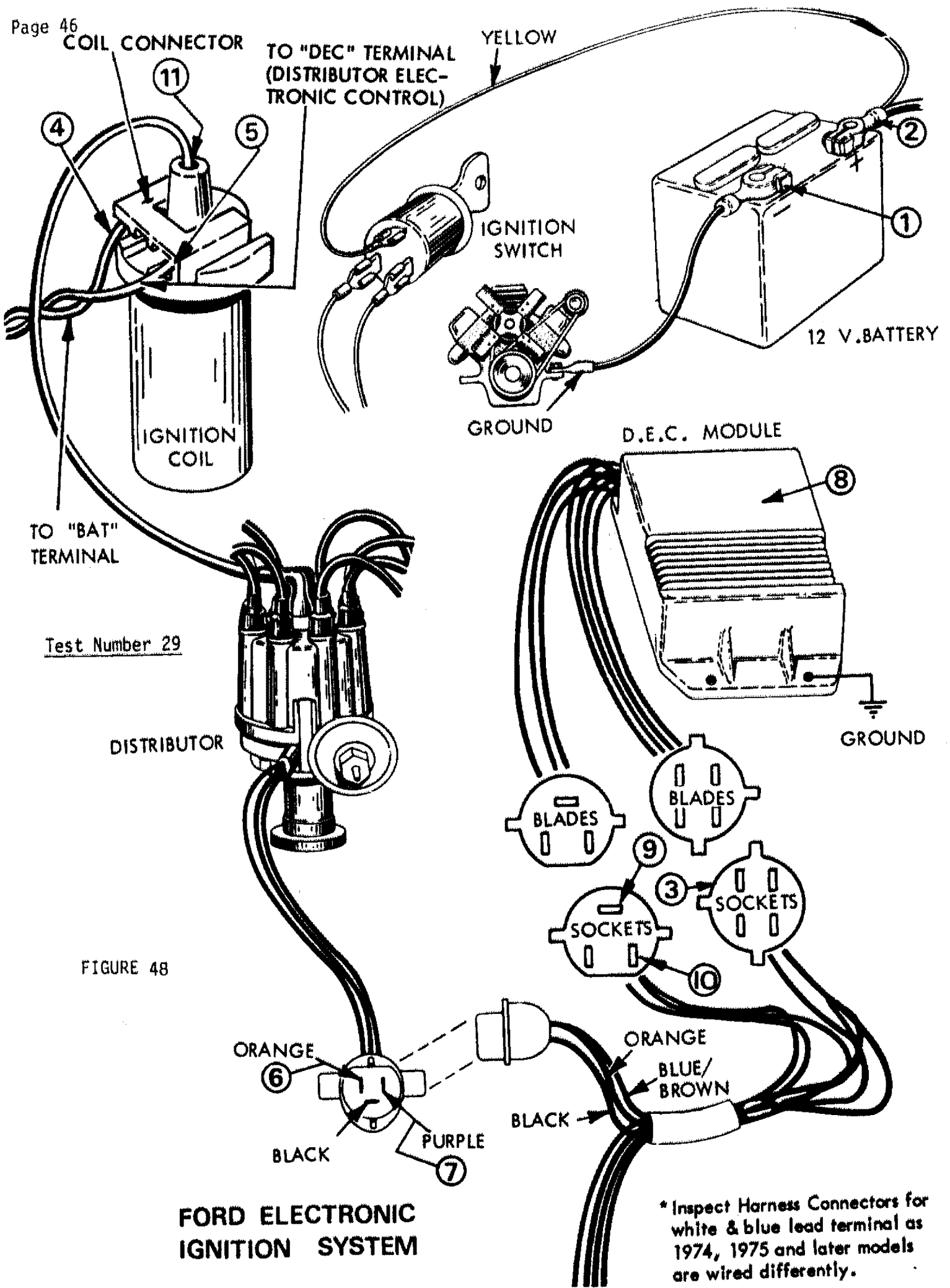

Test Number 29 Continued

FORD ELECTRONIC IGNITION COMPONENTS

TEST	SELECTOR KNOB POSITION	CLIP CONNECTIONS		TEST PROCEDURE AND RESULTS
		RED	BLACK	
A Battery State of Charge	16 VOLTS	2 Battery Pos. (+)	1 Battery Neg. (-)	Remove Coil High Tension Wire from the distributor and ground it. Crank Engine. Meter should read at least 9 volts. If less, charge battery and proceed. Replace High Tension Wire.
B Resistance Wire	OHMS x 1	9	10	With Ignition Switch OFF, meter should read 1 to 2 ohms. If reading is higher, replace resistance wire.
C Coil Primary Resistance	OHMS x 1	4 Coil BAT. Terminal	5 Coil DEC Terminal	With Ignition Switch off, meter should read 1 to 3 ohms. If it does not, replace Ignition Coil. If OK, proceed with Test D.
D Coil Secondary Continuity	OHMS x 1000	4 Coil BAT. Terminal	11 Coil Tower Contact	Remove coil high tension lead from coil tower. Connect BLACK clip to inner contact. With Ignition Switch off, meter should read 5,000 to 25,000 ohms. If it does not, replace coil.
E Voltage Drop in Resistance Wire	16 VOLTS	2 Battery Pos. (+)	4 Coil BAT. Terminal	With Ignition Switch on, meter should read 5 to 7 volts. If higher than 7 volts, recheck Test B. If lower, proceed with Tests F and G.
F Power to DEC Module	16 VOLTS	3 White/Blue Lead Terminal	1 Battery Neg. (-)	Separate the Harness Connector containing White/Blue Wire from DEC Module, and connect RED clip to White/Blue Female Lead Terminal. With Ignition Switch on, meter should read 10 to 13 volts. If low or zero, perform voltage drop test on Ignition Switch Resistance Wire, Test E. If OK, replace Ignition Switch.
G Pick-up Coil to Ground	OHMS x 1000	6 Orange Distributor Pick-up Connector Terminal	1 Battery Neg. (-)	Meter should not move. If there is movement or a full scale reading, replace Pick-up Coil Assembly.
H Pick-up Coil Continuity	OHMS x 1000	6 Orange Distributor Pick-up Connector Terminal	7 Purple Distributor Pick-up Connector Terminal	Meter should read between 400 and 800 ohms. If it reads higher or lower, replace Pick-up Coil Assembly.
J Module Ground	POINTS See Note #1	8 DEC Module Case	1 Battery Neg. -	With Ignition Switch on, momentarily touch GREEN clip to DEC Module Housing. If meter reads more than 0.25 volt, remove Module from mounting, clean surfaces, remount securely and retest.

Note #1 - Use GREEN and BLACK leads for this test only.

If tests above do not locate defective components, then the trouble is with the Electronic Control Unit. Since this unit is not serviceable, it must be replaced.

Test Number 30

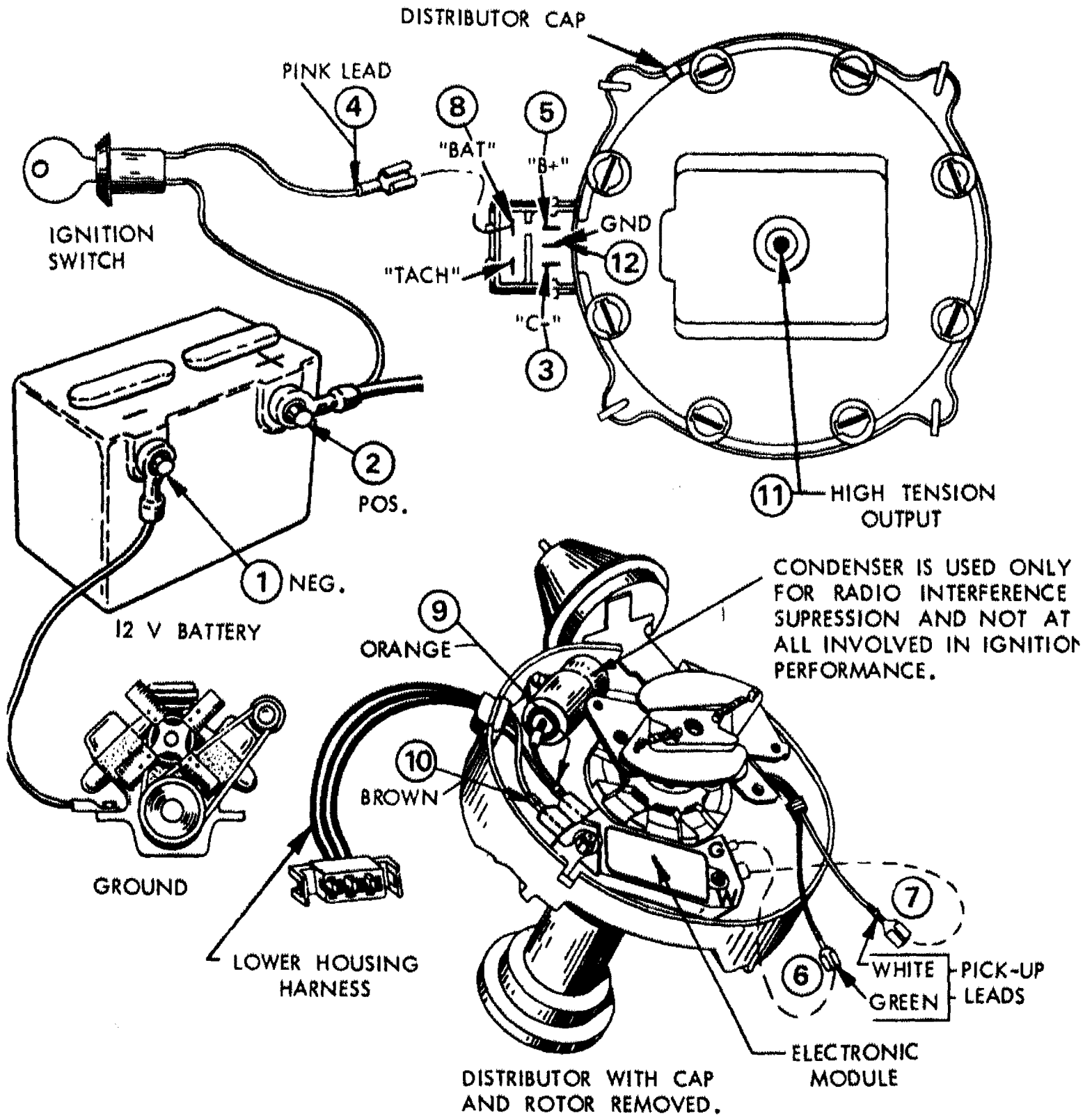

DELCO HEI IGNITION SYSTEM WITH COIL IN DISTRIBUTOR CAP

FIGURE 49

DELCO HEI IGNITION COMPONENTS—SYSTEMS WITH COIL IN DISTRIBUTOR CAP

TEST	SELECTOR KNOB POSITION	CLIP CONNECTIONS		TEST PROCEDURE AND RESULTS
		RED	BLACK	
A Battery State of Charge	16 VOLTS	2 Battery Pos.(+)	1 Battery Neg.(-)	Remove Pink Lead 4 from Distributor Cap and crank engine. Meter should read at least 9.6 volts. If lower, charge battery and retest.
B Ignition Switch	16 VOLTS	4 Dist. Cap Pink Lead	1 Battery Neg.(-)	Connect RED clip to Pink Lead from Distributor Cap. With Ignition Switch on and engine not running, meter should read 10 volts or higher. If low, replace Ignition Switch circuit.
C Coil Primary Resistance	OHMS x 1	3 Dist. Cap "C-" Term.	8 BAT. Term. at Dist. Cap	Remove Cap and Rotor, and disconnect Lower Housing Harness. Meter should read between 0.2 and 0.7 ohms. If meter does not read, replace Ignition Coil located in Distributor Cap.
D Coil Secondary Resistance	OHMS x 1000	11 High Tension Output Terminal	12 Dist. Cap Gnd. Term	With Ignition Switch off, meter reads less than 10,000 or more than 30,000 ohms, replace the Ignition Coil Assembly.
E Coil Primary Continuity	16 VOLTS	3 Dist. Cap "C-" Term.	1 Battery Neg.(-)	Reconnect Pink Lead 4. Be sure that three lead Lower Housing Harness is disconnected from Distributor Cap. Connect RED clip to "C-" Terminal. With Ignition Switch on, meter should read at least 10 volts.
F Power to Electronic Package	16 VOLTS	5 "B+" Term. at Dist. Cap	1 Battery Neg.(-)	With RED clip connected to "B+" Terminal and Ignition Switch on, meter should read at least 10 volts. If lower or zero, recheck Test B. If still low, examine terminals and connections inside Distributor Cap Cover.
G Lower Housing Harness Continuity	16 VOLTS	9 "B" Term. on Module	1 Battery Neg.(-)	Reconnect three lead Lower Housing Harness connectors. With Ignition Switch on, meter should read at least 10 volts. If low or zero, repair or replace three lead "Lower Housing Harness."
H Lower Housing Harness Continuity	16 VOLTS	10 "C-" Term. on Module	1 Battery Neg.(-)	Connect RED clip to Module "C-" Terminal. With Ignition Switch on, meter should read at least 10 volts. If low or zero, repair or replace three lead "Lower Housing Harness."
J Pick-up Coil Continuity	OHMS x 1000	7 White Pick-up Lead	6 Green Pick-up Lead	Disconnect Green and White Pick-up Leads from Electronic Module and connect to RED and BLACK clips. Meter should read between 550 and 1,500 ohms. If it does not, replace Pick-up Coil Assembly.
K Pick-up Coil to Ground	OHMS x 1000	7 White Pick-up Lead	1 Battery Neg.(-)	Connect RED clip to White Pick-up Lead. Be certain GREEN Lead is clear from all metal surfaces. Meter should not move. If it does, replace Pick-up Coil Assembly.

If tests above do not locate defective components, then the trouble is with the Electronic Control Unit. Since this unit is not serviceable, it must be replaced.

Test Number 31

IGNITION SWITCH

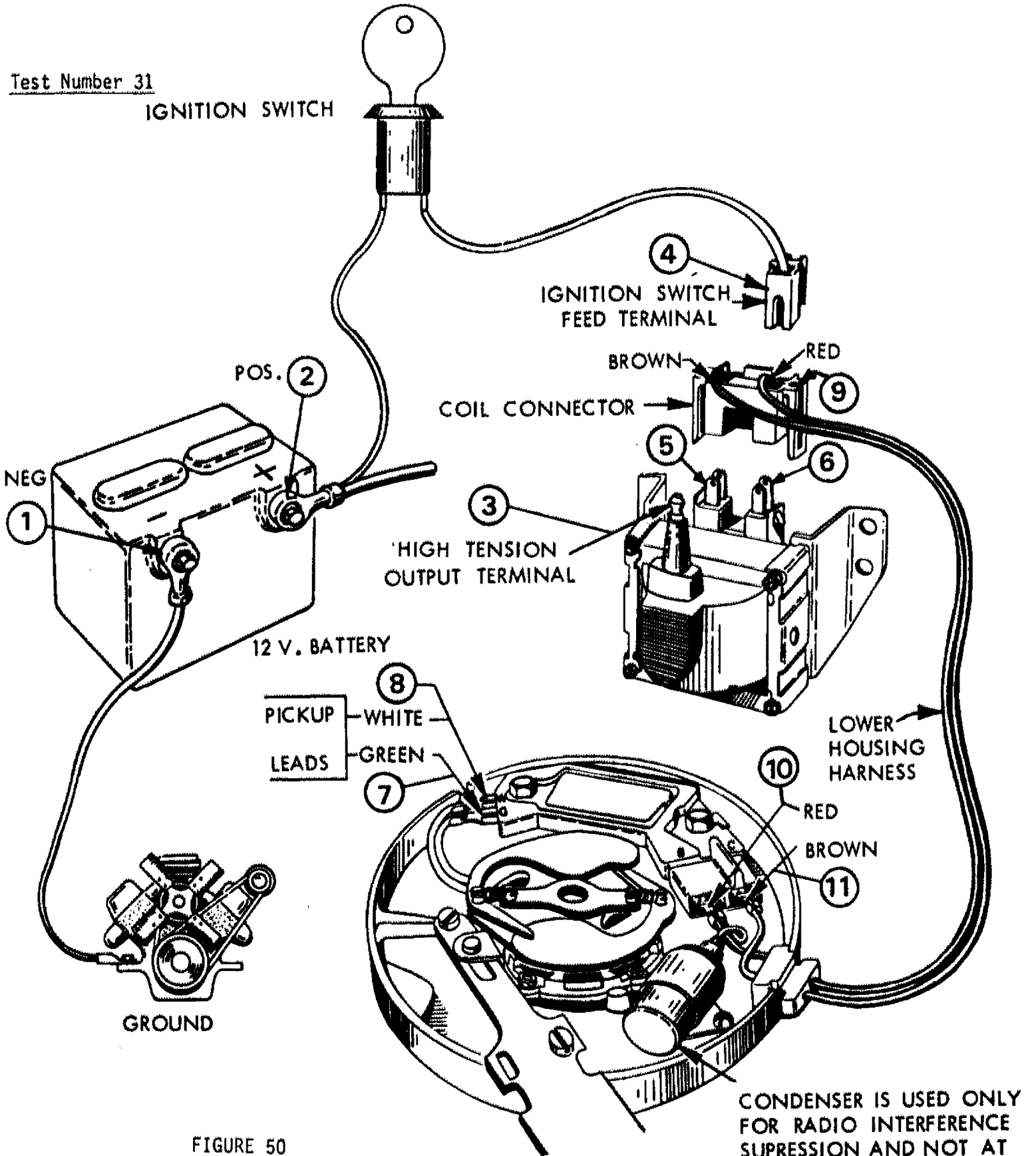

FIGURE 50

CONDENSER IS USED ONLY FOR RADIO INTERFERENCE SUPPRESSION AND NOT AT ALL INVOLVED IN IGNITION PERFORMANCE.

DELCO HEI IGNITION SYSTEM WITH SEPARATE COIL

DELCO HEI IGNITION COMPONENTS—SYSTEMS WITH SEPARATE COIL

TEST	SELECTOR KNOB POSITION	CLIP CONNECTIONS		TEST PROCEDURE AND RESULTS
		RED	BLACK	
A Battery State of Charge	16 VOLTS	2 Battery Pos.(+)	1 Battery Neg.(-)	Remove Ignition Switch Feed Terminal from Coil and crank engine. Meter should read at least 9.6 volts. If lower, charge battery and proceed.
B Ignition Switch	16 VOLTS	4 Ignition Feed Wire	1 Battery Neg.(-)	Remove coil cover and Ignition Wire No. 4. Connect RED clip to Ignition Switch Feed Terminal. With Ignition Switch on, meter should read at least 10 volts. If low or zero, replace Ignition Switch circuit.
C Coil Primary Resistance	OHMS x 1	5 Ignition Coil Terminal	6 Coil Terminal	Remove Coil Connection, and connect RED clip to Ignition Coil Terminal, and BLACK clip to Coil Terminal. Meter should read between 0.2 and 0.7 ohms.
D Coil Secondary Resistance	OHMS x 1000	3 High Tension Output Terminal	5 Ignition Coil Terminal	Remove Coil High Tension Wire, and connect RED clip to High Tension Output Terminal, BLACK clip to Ignition Coil Terminal. Meter should read between 6,000 and 12,000 ohms. If not, replace coil. Reconnect High Tension Wire.
E Lower Housing Harness (Red) Continuity	16 VOLTS	10 "B" Terminal on Module	1 Battery Neg.(-)	Remove distributor cap and rotor. Reconnect Coil Connector and Ignition Feed Wire to Coil. With Ignition Switch on, meter should read at least 10 volts. If lower, repair or replace Lower Housing Harness.
F Lower Housing Harness (Brown) Continuity	16 VOLTS	11 "C" Terminal on Module	1 Battery Neg (-)	With Ignition Switch on, meter should read at least 10 volts. If lower, repair or replace Lower Housing Harness.
G Pick-up Coil Resistance	OHMS x 1000	8 White Pick-up Lead	7 Green Pick-up Lead	Disconnect Green and White Pick-up Leads from Module and connect to RED and BLACK clips. Meter should read between 500 and 1,500 ohms. If it does not, replace Pick-up Coil Assembly.
H Pick-up Coil to Ground	OHMS x 1000	8 White Pick-up Lead	1 Battery Neg.(-)	Connect RED clip to White Pick-up Lead. Be certain Green Lead is clear from all metal surfaces. Meter should not move. If it does, replace Pick-up Coil Assembly. Reinstall distributor cap and rotor.

If tests above do not locate defective components, then the trouble is with the Electronic Control Unit. Since this unit is not serviceable, it must be replaced.

Test Number 32--The General Motors C-3/C-4 System (Computer Command Control)

Introduced in 1978 on a limited number of California mandated emission-controlled engines, the C-4 System is now standard equipment on most of the General Motors cars (except diesel and EFI). The main function of the C-4 System is to maintain the carburetor air-fuel ratio at 14.7 to 1.0--the most efficient operating ratio for the catalytic converter. The electronic carburetor receives a DWELL-TYPE voltage from the Electronic Control Module (ECM) to maintain this air-fuel ratio under widely varying driving conditions. The Craftsman Engine Analyzer can be used to check this voltage by reading the six-cylinder DWELL scale, 0-60°, and by performing the procedure in this section.

IMPORTANT--The C-4 System could be malfunctioning when any of the following conditions are noticed:

- a) The vehicle instrument panel "CHECK ENGINE" light illuminates.
- b) Poor engine performance which includes:
 - 1. Poor gas mileage
 - 2. Lack of response to throttle
 - 3. Hesitation, stalling, etc.

Complete C-4 System diagnostics, troubleshooting, and repair procedures demand that you obtain the specific service manual for your vehicle and engine combination.

CONNECTIONS:

On G.M. cars equipped with the C-4 System, a small, green, single-contact DWELLMETER connector is normally provided to check the DWELL voltage to the carburetor (usually located under the hood near the right front fender wheel well, or near the carburetor, protruding from the wiring harness). DO NOT ALLOW THE LEADS TO TOUCH GROUND OR HOSES--THE HOSES MAY ALSO BE CONDUCTIVE.

Use the adapter pin as shown in the figure below. Connect the GREEN clip from the Craftsman Engine Analyzer to the adapter pin. Connect the BLACK clip to a clean and secure ground such as the engine block, and the RED clip to the positive (+) battery terminal.

NOTE: The DWELLMETER should NOT cause a change in the engine operation when connected to the vehicle's DWELLMETER connector. If there is reason to suspect that a change did occur, recheck your connections.

TEST PROCEDURE

Position the FUNCTION SELECTOR switch on the Craftsman Engine Analyzer in the DWELL position. All readings will be taken from the 6-cylinder DWELL scale (0-60°), regardless of the number of engine cylinders in the vehicle under test.

The following table is a typical C-4 System Performance Summary illustrating the DWELLMETER readings under the given engine conditions.

<u>ENGINE CONDITION</u>	<u>DWELLMETER READINGS</u>
1. Start Mode (cranking)	0°
2. Warm engine operation at idle or part-throttle with constant engine speed. See Note Below.	Constantly varying between 10° and 50° (Higher engine speeds result in faster variations.)
3. Acceleration and deceleration (changing engine speed)	Constantly varying between 10° and 50° (DWELL variations may not be easily discernible on the DWELLMETER during rapid accelerations or decelerations but may be seen on slower changes in engine RPM)
4. Wide open throttle (W. O. T.) (under engine load--on the road or with dynamometer).	Approx. 6°

NOTE: The input to the C-4 System which causes the constantly varying DWELL reading is an oxygen sensor mounted on the exhaust manifold working through the ECM. This sensor must typically be above 600° F to operate properly. Engine cooling, restart, or excessive idling could cause the sensor to go below 600°F in which case the DWELLMETER reading will be some FIXED value between 10° and 50°. This system may require three to four minutes to reach temperature after a restart or cool-down to resume the VARYING-DWELL operational mode.

ADAPTOR PLUG CONNECTOR



FIGURE 51

Used to provide Dwell Connection on G.M. C-4 Systems.

Test Number 33--Ground Strap Test (Engine to Body)

The ground strap from the vehicle body to the engine provides the return circuit from the lights and other accessories to the battery. A defective ground strap or ground connections could cause an inaccurate voltage regulator setting, resulting in higher voltages to the electrical system. The ground strap can be tested as follows:

1. Insert the BLACK test lead plug into the BLACK "OTHER TESTS" socket.
2. Connect the BLACK clip to a clean connection on the engine block and the GREEN clip to a clean connection on the car body. Scrape away grease or paint, if necessary, to make a good metal-to-metal connection.
3. Rotate Selector Switch to the POINTS LO VOLTS position.
4. Start engine and operate at approximately 1200 RPM.
5. Turn on headlights and note reading on the 0-3.2 Volt scale.

GOOD--A reading less than .1 volt indicates a good ground strap and connections.

HIGH--A reading exceeding .1 volt indicates a defective ground strap or its connections. Clean the ground strap connections and repeat test before replacing ground strap.

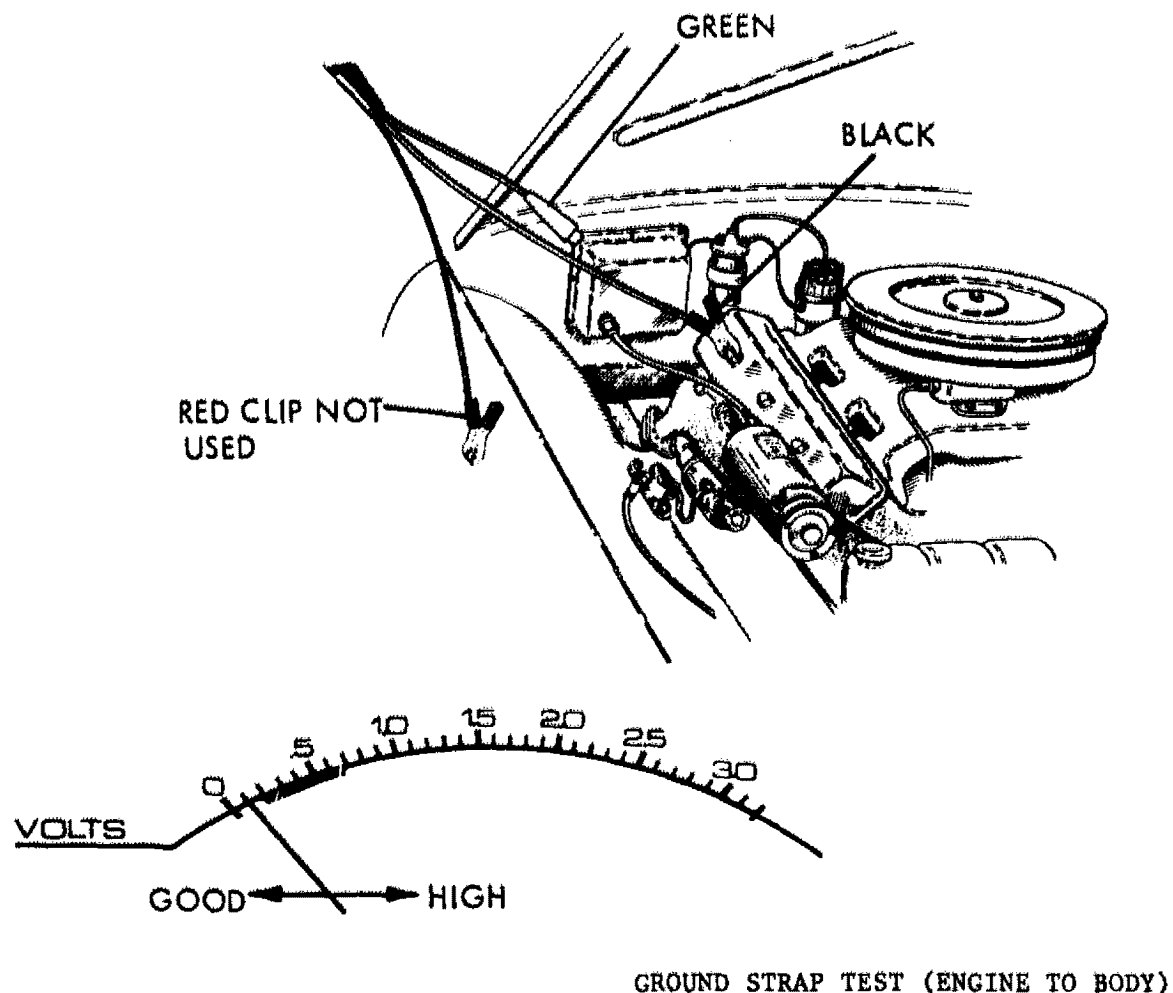
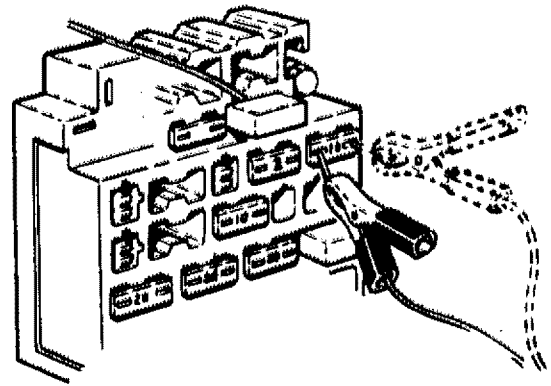

FIGURE 52

Test Number 34A--Fuse Tests

Automotive fuses can be tested as follows:

Connect the BLACK clip from the analyzer's voltmeter lead to a good ground on the engine or car body. Turn the Function Selector Switch to the VOLTS position. Insert the BLACK plug into the BLACK OTHER TESTS socket. Turn the ignition switch to the ACC. position and turn on the accessory associated with the fuse that is to be tested. Then touch both sides of the fuse with the RED clip. If the meter indicates battery voltage on both sides of the fuse, the fuse is good. If it indicates battery voltage on one side and nothing on the other, the fuse is open. If there is no reading on either side, there is an open circuit between the fuse and the battery



On General Motors cars equipped with "Autofuse" blocks, insert a small nail or bare wire in the RED clip as shown and use it as a test probe.

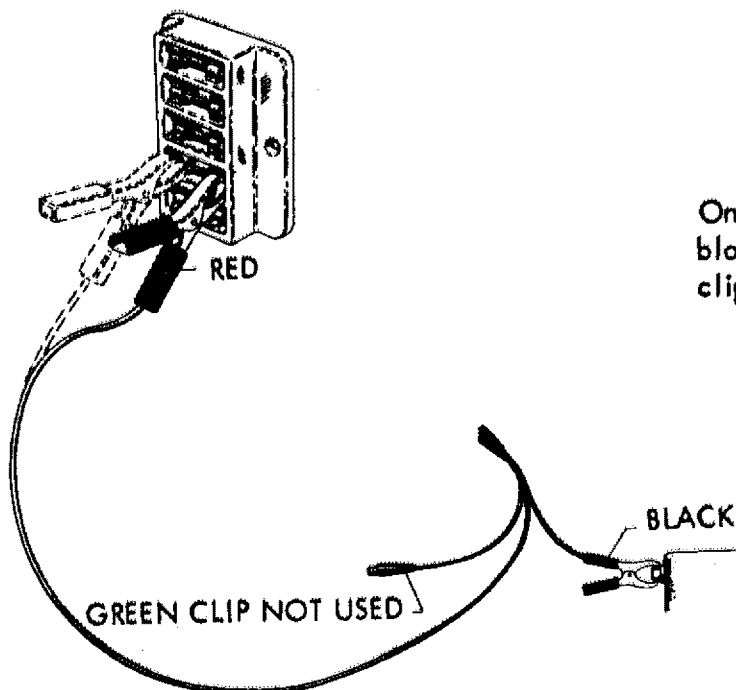

FUSE TEST CONNECTIONS

FIGURE 53

Test Number 34B--Horn

1. Set the Function Selector Switch to the VOLTS position.
2. Using the ALL OTHER TESTS leads, connect RED lead to the terminal of the horn relay that connects to the horns and BLACK lead to a good ground as shown in Figure 57. (Reverse leads for a positive ground system).

HORN AND RELAY
CIRCUIT CONNECTIONS

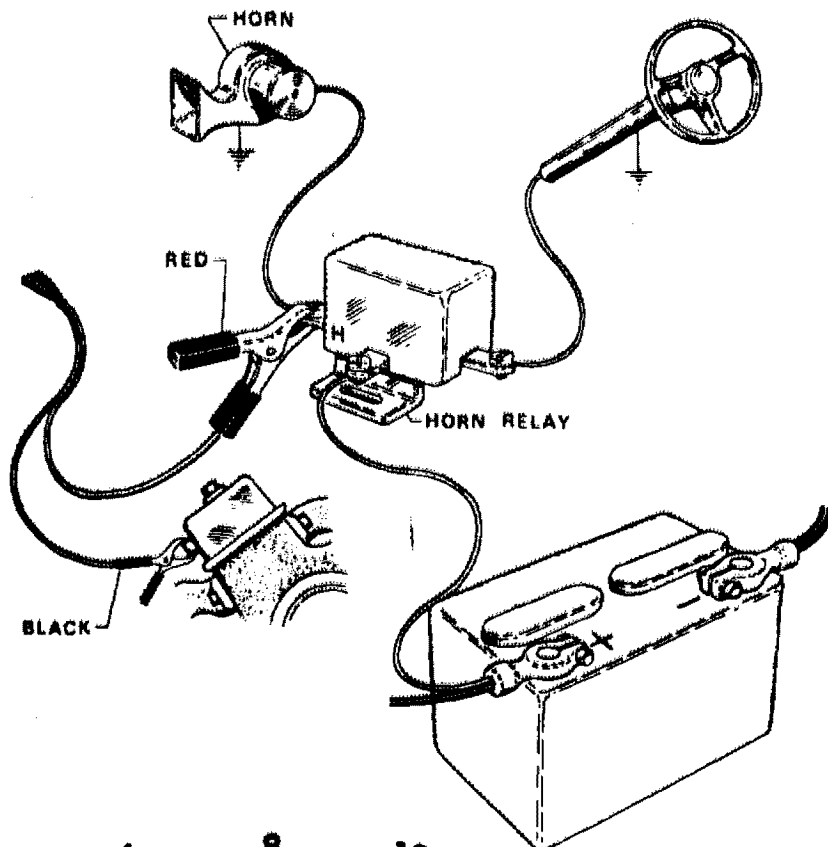

TEST RESULTS

FIGURE 54

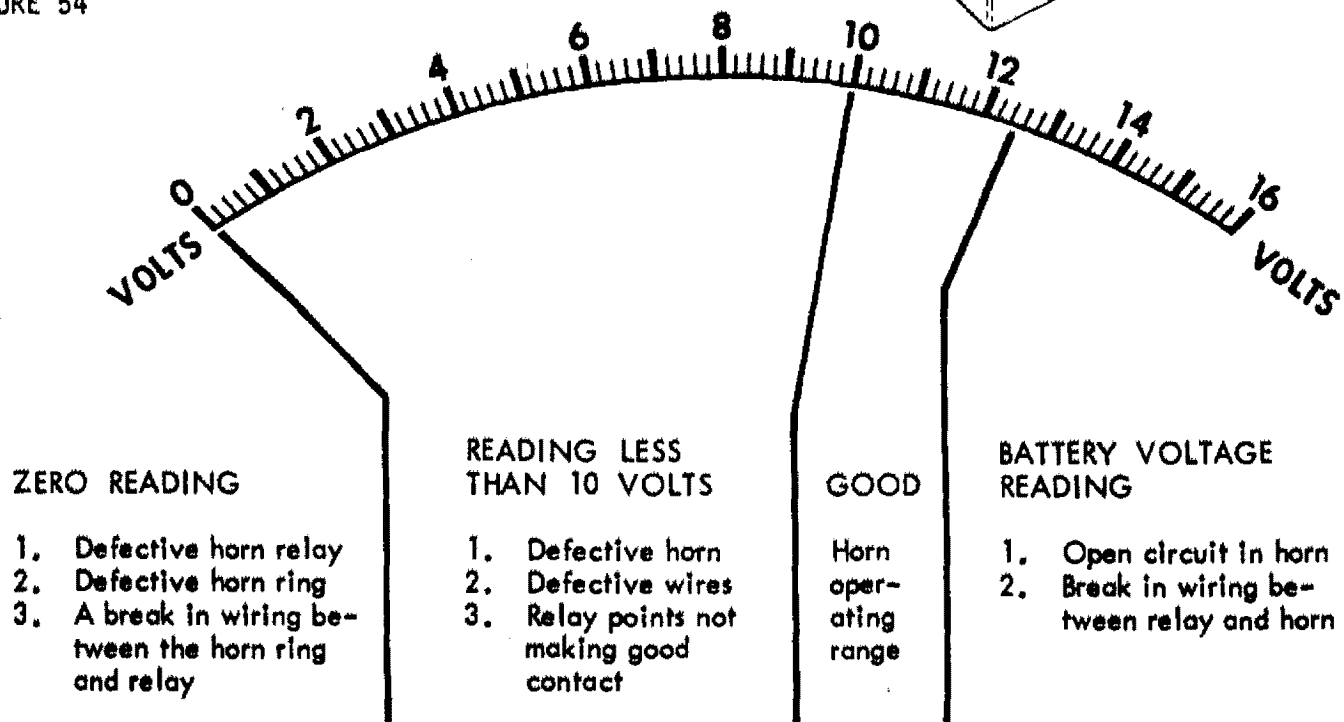

Test Number 34C--Low Voltage Drop Tests

In addition to the POINT RESISTANCE test described on page 20, this position can be used to test the vehicle's electrical system for low voltage drops. Set the Function Selector Knob to the POINTS LOW VOLTS position.

Insert the BLACK plug into the BLACK OTHER TESTS socket. Read test results on the 0-3.2 Volt scale. Each division on this scale is .1 volt. This scale has internal protection to prevent damage if the leads are accidentally connected across full battery voltage. Use the GREEN and BLACK clips to make the tests. The RED clip is not used.

Corroded or loose connections and frayed or broken cables can cause excessive voltage drops in the starting circuit which can cause hard starting. To test for these conditions, connect the clips between 1 and 2, 2 and 3, 4 and 5, 5 and 6, 6 and 7, 7 and 8, with the starter turning. Be sure the high voltage lead is disconnected from the coil so the engine won't start. During this test, no reading should be higher than .2 volts. If a reading higher than .2 volts is observed during any of these tests, check the cable or connections involved, clean and tighten the connections and replace the cables or solenoid when necessary. If the meter reads to the left of zero during any of the above tests, reverse the position of the clips.

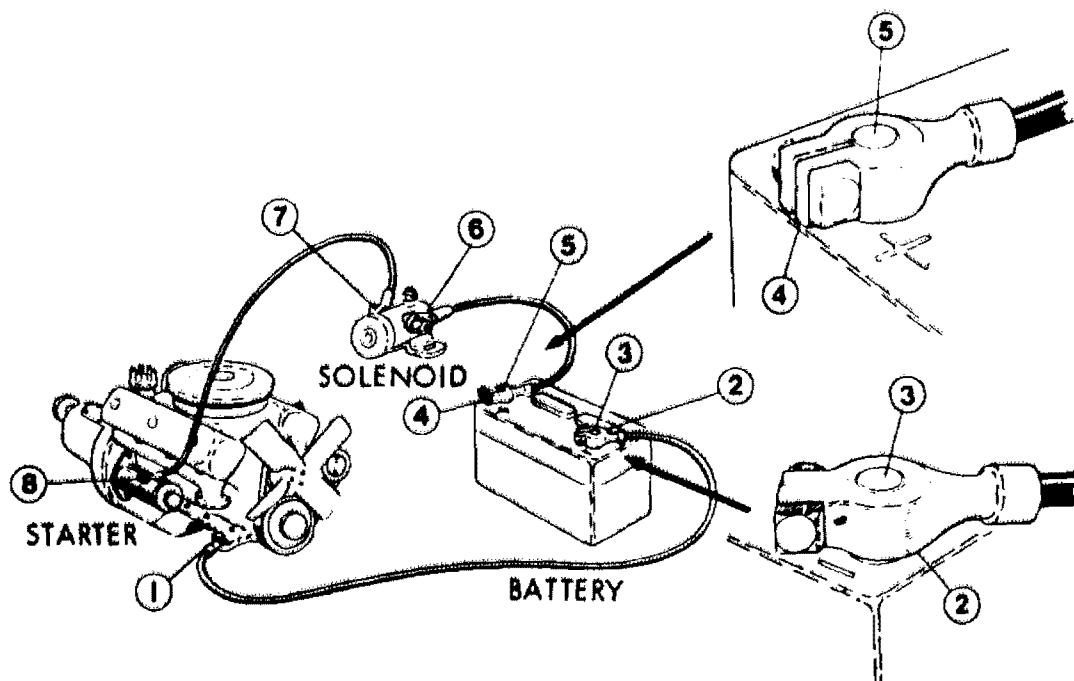

VOLTAGE LOSS TEST CONNECTIONS

FIGURE 55

Test Number 34D--Emission Control System Solenoids

With the increased sophistication of today's emission control systems, many more solenoids are used than ever before. Air injection, EGR Action, and throttle positioning are a few examples of the usage of solenoids.

Basically a solenoid converts an electrical signal into mechanical movement. Hence they can be used to move valves or reposition the throttle. Since they are electrically operated, your Craftsman Voltmeter and Ohmmeter can be used in conjunction with your vehicle service manual to confirm their proper operation. The service manual will tell when voltage should be present at the solenoid and the value to activate it. The Ohmmeter can check whether or not the coil in the solenoid is open or shorted. Follow your vehicle service manual's instructions in all cases.

Test Number 34E--Lamps

The OHMS scale is used to test the various lamps in the vehicle (headlamps, parking lamps, convenience lamps, etc.) To test the lamps, remove the lamp from the socket or otherwise disconnect from the circuit to prevent possible damage to the analyzer.

CONNECTIONS:

1. Insert the white plug OHMS lead into the corresponding tester socket.
2. Connect the RED and BLACK clips to the lamp under test. Some lamps have two filaments and each must be tested separately.
3. Set the Function Selector switch to the OHMS position.
4. Set the Range Selector Switch to the LOW scale. The cold filament resistance will read very low--typically less than 10 OHMS.
5. If the meter reads ∞ , (extreme right hand side of the scale) the filament is open-circuited and the lamp must be replaced.

Test Number 34F--Motor Windings

The OHMS scale can be used to test the windings of many of the motors used in today's vehicles such as the blower, wiper, headlamp doors, and power window motors. Always make certain when testing the suspect motor that it is completely disconnected from the vehicle. This will prevent false readings as well as possible damage to the Analyzer.

With the guidance of your vehicle service manual you will be able to diagnose an open winding, a shorted winding, or a winding shorted to the motor frame. Your vehicle service manual will specify what resistance in ohms should be present across the various motor leads. These values will typically be low in value, hence the X 1 position of the Craftsman Analyzer Range Selector should be used.

Test Number 34G--Rear Window Defroster Grid

The Rear Window Defroster Grid can be checked quite easily with your Craftsman Analyzer. You will use either the VOLTMETER, 0-16 VOLTS, or the OHMMETER (X 1) for performing these tests. Specific test procedures are outlined in your vehicle service manual. Resistances encountered in these circuits will be very low, typically less than one ohm.

CAUTION: Do not test across Grid Lines on the glass. Although this electrically conductive coating is baked onto the glass, it can be scratched, causing an open circuit and rendering all or part of the heated rear window inoperable. Measure only at the terminals with connector disconnected.

WARNING: Ford Motor Company uses a separate high voltage alternator for its quick defrost windshield and rear window on some car lines. Operating voltage in this system approaches 120 Volts A. C. Do not attempt to test this system while "live". Make only Ohmmeter Tests as instructed in the Ford Manual with the engine off!

Test Number 34H--Electrical Wiring Harness

All power distribution within the vehicle takes place via one or more color coded wiring harnesses. If a wire in the harness breaks or a connector is loose or corroded, voltage will not arrive at its intended destination. The end result of this is that one or more electrically operated devices in the vehicle will not operate as they should.

By using your Craftsman Analyzer, Voltmeter, Ohmmeter, and Points (Low Voltmeter) functions, and with the guidance of your service manual you can correct certain harness defects.

CAUTION: If you are tracing voltage through a given system, be careful not to short that voltage to ground. A spark can cause electrical system damage or in the vicinity of the fuel system vapors could ignite and cause a fire, and personal injury.

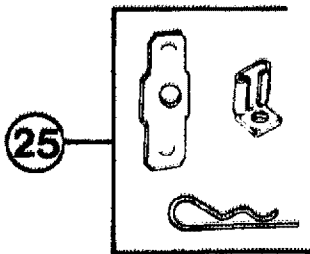
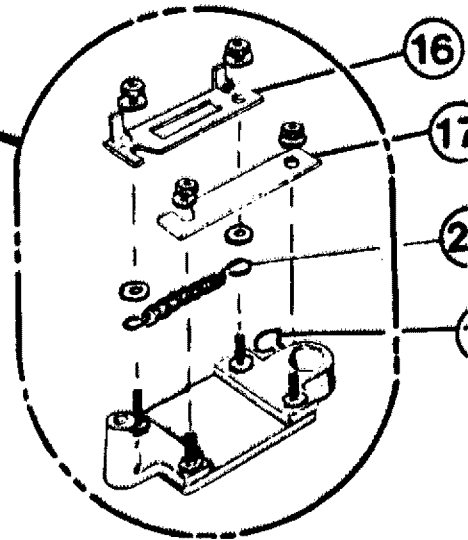
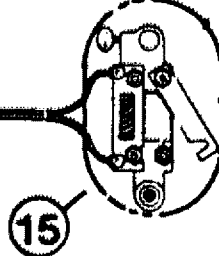
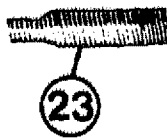
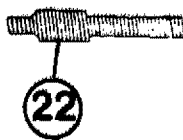
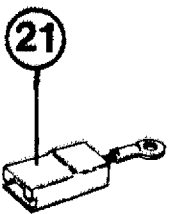
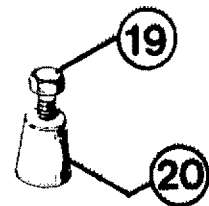
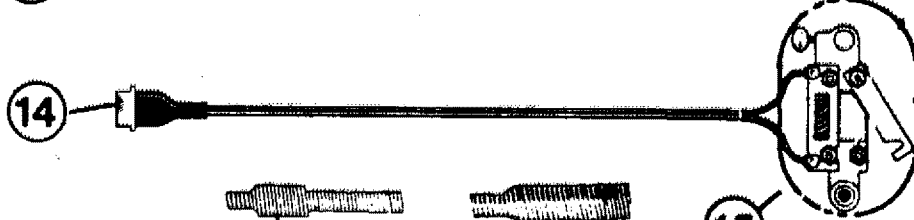
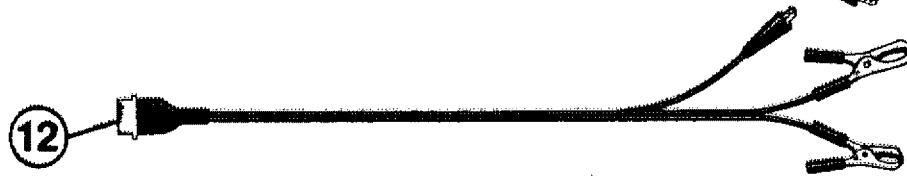
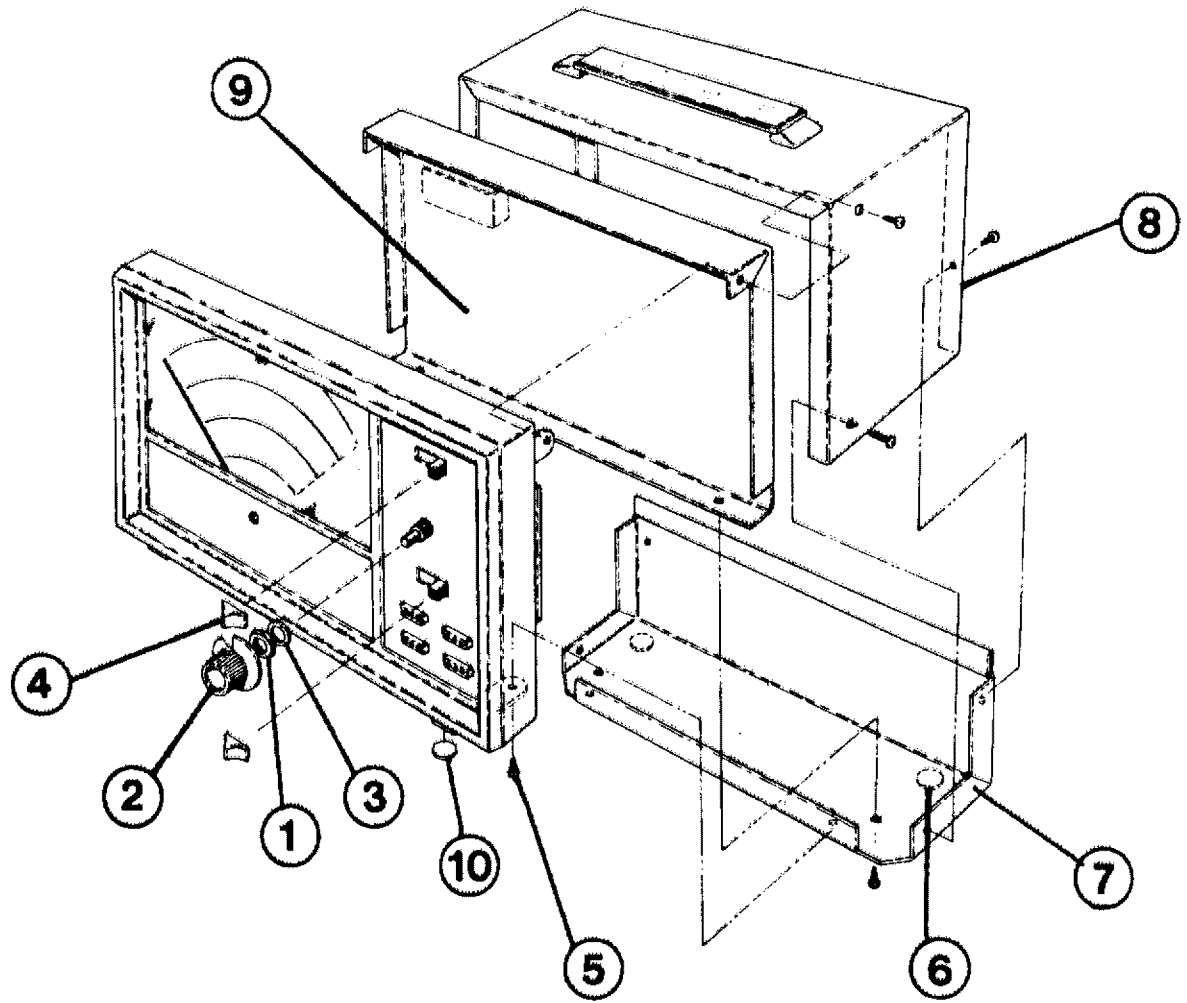

TABLE 1

Key No.	Part No.	Description
1	290-102	Nut, 3/8-32
2	450-132	Knob, Selector
3	210-105	Washer, Flat 3/8
4	450-130	Glamor Cap
5	STD610605	Screw, Self Tap #6 x 1/2 Lg.
6	400-290	Rest Pad (2)
7	180-740	Case, Bottom and Back
8	1000-752	Case, Top Assembly
9	180-739	Case, Baffle
10	400-467	Rest Pad (2)
11	38-513	Cable Assembly, Ohms
12	38-512	Cable Assembly, Other Tests
13	38-568	Cable Assembly, Tach Pick-Up
14	38-514	Cable Assembly, Amps (Cable Only)
15	1000-840	Battery Adaptor
16	1000-252	Shunt and Terminal Assembly
17	180-457	Starter Shunt
18	260-183	Thumb Screw
19	260-171	Screw Hex 3/8-16 x 1-1/4" Lg.
20	180-618	Battery Adaptor, Male
21	1000-248	Alternator Adaptor
22	180-298	Adaptor Spring (Foreign)
23	180-293	Adaptor Spring (Domestic)
24	38-396	Wire Adaptor (Jumper)
25	1000-425	Accessory Kit
26	2-170701	Instruction Manual (Not Illustrated)
27	1000-836	Complete Accessory Kit (Not Illustrated)
28	25-185	1/4 OHM Resistor

Sears

**owners
manual**

**MODEL NO.
161.210400**

**HOW TO ORDER
REPAIR PARTS**

ENGINE ANALYZER

Now that you have purchased your CRAFTSMAN ENGINE ANALYZER, should a need ever exist for repair parts or service, simply contact any Sears, Roebuck and Co. stores. Be sure to provide all pertinent facts when you call or visit.

The model number of your ENGINE ANALYZER can be found on the front of the instrument.

WHEN ORDERING REPAIR PARTS, ALWAYS GIVE THE FOLLOWING INFORMATION:

- PART NUMBER • PART DESCRIPTION
- MODEL NUMBER • NAME OF ITEM

All parts listed may be ordered from any Sears Service Center and most Sears stores.

If the parts you need are not stocked locally, your order will be electronically transmitted to a Sears Repair Parts Distribution Center for handling.

**SEARS, ROEBUCK AND CO. U.S.A
CHICAGO, ILLINOIS 60684**