

OWNER'S MANUAL

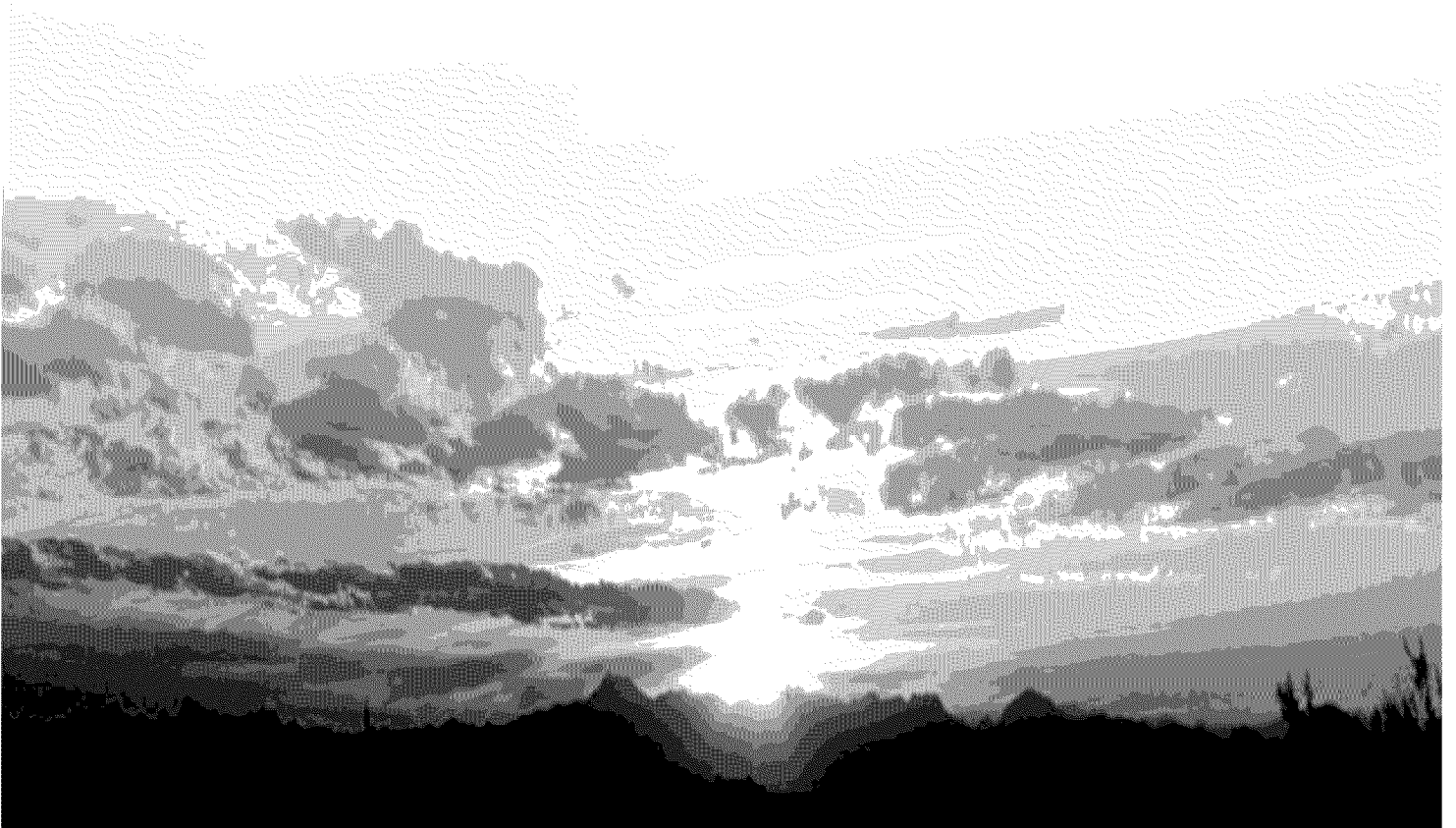

NOTICE!

FOR MISSING PARTS:

1-800-775-1965 or 1-800-366-1599

**PLEASE DO NOT
RETURN THIS UNIT TO
THE RETAIL STORE**

TROUBLESHOOTING GUIDE

PROBLEM	SOLUTION
1. CONDENSATION	THIS IS CAUSED BY LOWER TEMPERATURES ON OUTSIDE OF PRODUCT COMBINED WITH BODY HEAT ON INSIDE OF PRODUCT. WHEN THIS OCCURS, AVOID TOUCHING WALLS TO REDUCE CONTACT LEAKAGE. LEAVING DOORS AND WINDOWS OPEN WILL REDUCE CONDENSATION.
2. MILDEW	TO AVOID MILDEW, NEVER STORE YOUR PRODUCT WET OR DAMP. HOWEVER, IF MILDEW OCCURS, USE A SOFT BRISTLE BRUSH OR SPONGE WITH MILD SOAP TO CLEAN. LET DRY IN THE SUNLIGHT AND APPLY SEAM SEALER COMPOUND ON INSIDE SEAMS.
3. REPAIRING A TEAR	FOR SMALL TEARS USE A SELF-ADHESIVE PATCH KIT. WE RECOMMEND A REPAIR SHOP FOR LARGER TEARS.
4. FAULTY ZIPPER	PRODUCTS ARE MANUFACTURED WITH ZIPPERS WHICH, IF THE ZIPPER SEPARATES, IT CAN BE FIXED BY MOVING THE SLIDER TO THE BEGINNING OF THE ZIPPER TAPE AND REWORKING THE ZIPPER. IF THIS DOESN'T WORK, A REPLACEMENT ZIPPER MAY BE ORDERED FROM OUR PARTS DEPARTMENT, AND MAY BE INSTALLED BY A REPAIR SHOP IN YOUR AREA.
5. FLOOR CONDENSATION <small>(ONLY APPLICABLE ON PRODUCTS WITH FLOOR)</small>	TO PREVENT FLOOR CONDENSATION USE A GROUND CLOTH. PLACING A GROUND CLOTH UNDER YOUR PRODUCT WILL PROLONG ITS LIFE. GROUND CLOTH SIZE SHOULD BE SLIGHTLY SMALLER THAN PRODUCT FLOOR SIZE.

PERHAPS WE'VE MISSED SOMETHING IN OUR TROUBLESHOOTING GUIDE. FEEL FREE TO GIVE US YOUR IDEAS ON "TRICKS OF CAMPING", REPAIR PROCEDURES, FEATURES YOU'D LIKE TO SEE, OR OTHER RECOMMENDATIONS. SEND THEM TO:

NORTHPOLE LIMITED
23 Town and Country Drive
Washington, MO 63090

A Message To Our Customers



Thank you for purchasing a quality product manufactured by NorthPole Limited. As the world leader in outdoor recreational products, we pride ourselves in delivering high quality and customer friendly products. As with any new product, it is very important to read all the information on safety, assembly/disassembly and care of your new purchase prior to usage.

As a valued customer, your satisfaction is very important to us. We at NorthPole Limited welcome your feedback and look forward to continuing our relationship with the development of new, innovative products to suit your needs.



Please visit your favorite retailer for other quality products from NorthPole Limited.

IMPORTANT: We advise you to assemble this product at least once at home before going on a trip to ensure that you have attained a satisfactory knowledge of the assembly process. Being familiar with your product will make it easier if you have to set up in the dark or under adverse conditions.

IMPORTANT SAFETY AND TIP INFORMATION

TO MAXIMIZE THE ENJOYMENT OF YOUR PRODUCT PLEASE ASSEMBLE AND USE YOUR PRODUCT AS SAFELY AS POSSIBLE. THE PURPOSE OF THE SAFETY ALERT SYMBOL  IS TO CALL YOUR ATTENTION TO POSSIBLE HAZARDS RELATING TO THE USE AND ASSEMBLY OF YOUR PRODUCT. THE PURPOSE OF THE TIP SYMBOL  IS TO CALL YOUR ATTENTION TO SUGGESTIONS THAT WILL ASSIST YOU IN THE ASSEMBLY/DISASSEMBLY PROCESS AND ENHANCE YOUR CAMPING EXPERIENCE. WHEN YOU SEE THESE SYMBOLS, PLEASE CLOSELY FOLLOW THE INFORMATION PROVIDED.

WARNING

- KEEP ALL FLAME AND HEAT SOURCES AWAY FROM THIS TENT FABRIC. This fabric is not fireproof! It is made with flame resistant fabric, which meets CPAI-84 specifications. The fabric may burn if left in continuous contact with any flame source. The application of any foreign substance to the fabric may render the flame-resistant properties ineffective.
- Do not erect this product near an open flame.
- Never use any fuel burning, oxygen consuming devices, or any device that produces fumes (including, but not limited to cooking stoves, lanterns, candles, hibachis, or heaters) in or around your product. Inhalation of fumes may result in carbon monoxide poisoning, injury and/or death.
- This product is not waterproof!
- Your product is water repellent, however, during heavy rain some leakage may occur. Keep objects from touching the inside, as objects may cause leakage at the point of contact.
- To prevent seam leakage (floor seams in particular), a seam sealer compound must be applied to the seams. Use recommended water repellent compounds on our product. Read the label on any product before using. Questions? Call our Customer Service number.
- Your recreational product is made from synthetic fabric that has been treated and is highly resistant to the sun's Ultraviolet (UV) light. No fabric can withstand prolonged exposure to sunlight. UV damage is not covered by the limited warranty.
- Do not spray or apply insecticide or pesticide on your product. It may damage UV resistant and/or water repellent properties of your product. Any damage caused by applying insecticide or pesticide on your product is not covered by the limited warranty.
- Our recreational products are constructed to rigid specifications. They are not made, however, for extreme weather, climates, or environments. Modification, abuse and extreme weather are some conditions that may adversely affect the structural integrity.
- Additional precautions may be necessary during inclement or "surprise" weather conditions. Here are some tips that may help during these times:
 -  Use guy lines to help secure your structure during periods of heavy winds.
 -  Storms or steady rains may collect in water pockets on the roof. This will add weight, which can weaken the overall structure causing the uprights to collapse. Maintain a watchful eye and remove any water accumulation that may occur.
- Your product must be stored dry. One of the easiest ways to damage your product is storing it while it is wet. Storing a wet tent as short as 24 hours in warm weather is likely to cause mildew on the fabric. Once mildew sets in, the stains are permanent. Stains cannot be removed without potential harm to the fabric coatings and are not covered by the limited warranty.
- If you must close camp in the rain, open your product and set it up to allow it to dry as soon as possible. Even when your product appears to be dry after use, it is always best to unfold and assure it is completely dry before storing. Hanging it outside or even leaving loosely clumped in your house for a few days, turning it inside and out to assure it has dried everywhere, can help prevent damage.
- This product is not machine washable. To clean product, use mild soap and let it dry thoroughly before storage.

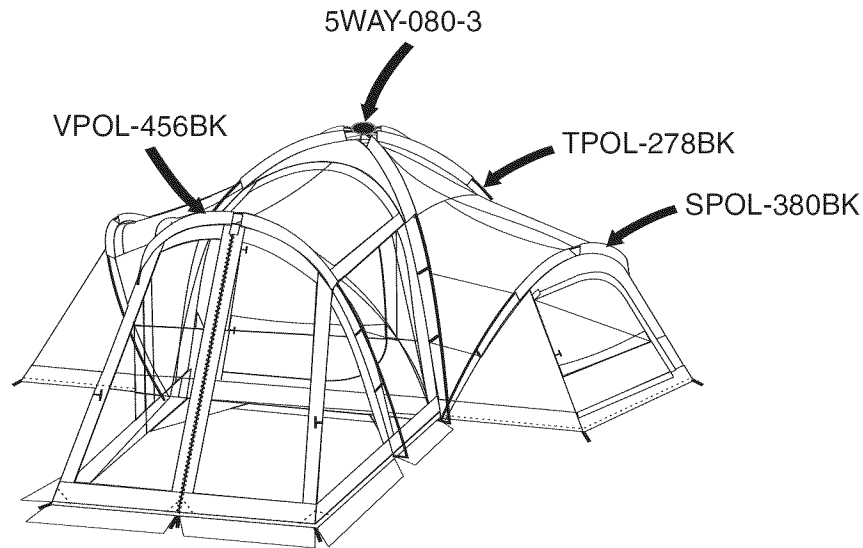

**Model # 38-65-35 Pentagon Dome w/ Screen Porch
15 ft. x 17 ft. (10 ft. + 7 ft.) x 76 in.**

✓	QTY.	DESCRIPTION	PART NUMBER
		<u>FABRIC BODY</u>	
___	1	Tent Body	N/A
		<u>POLES</u>	
___	5	Fiberglass, shock-corded Long Tent Pole- black	TPOL-278BK
___	2	Fiberglass, shock-corded Side Tent Pole- black	SPOL-380BK
___	1	Fiberglass, shock-corded Screen Vestibule Pole- black	VPOL-456BK
		If you wish to order a complete set of poles, please use:	
___	1	Pole Set of all Eight Fiberglass, shock-corded Poles- black	PSET-BK
		<u>RAINFLY</u>	
___	1	Rainfly w/11 S-Hooks; navy/ olive trim	RFLY-NVOL06
		<u>CARRY BAG</u>	
___	1	Carry Bag- navy	CBAG-730NV
		<u>UNIVERSAL PARTS</u>	
___	1	5 Way Center Hub	5WAY-080-3
___	1	Pole Bag	PBAG-29IN
___	1	Remote Control Light Set; 2pc	LITERC
___	1	Stake Bag	SBAG-10IN
___	7	Guy Ropes; 2.5M	GROPE-2.5M
		<u>STAKES</u>	
___	1	Stake Set of Twenty-One 7 in. steel stakes	SSET-21ST7IN

Review your parts list above to make sure all parts listed above have been included in your package.

Please do NOT return product to store.

**Call our TOLL FREE Numbers: 800 775-1965 or 800-366-1599 Monday-Friday 7am - 5pm CST
Mention your complete Model Number so that our Representative may assist you!**

ASSEMBLY INSTRUCTIONS

- * Unless otherwise specified all instructions will be given assuming the assembler is facing the front opening of the tent.
- * Carefully fold out your poles, using caution to prevent snapping the shock-cording. Make sure each pole segment is "seated" into the next section before flexing the pole during set-up.
- * Do not drop tent pole bag. Do not bounce tent bag on its end to remove tent, as these actions may damage the shock-cording and/or pole ends.

STEP 1: Verify Package Contents

Verify package contents by emptying contents of bag(s) and confirming all parts are included and undamaged. Tip: Do this at home before you leave on your trip.

STEP 2: Install the Main Tent Poles

A) Select a smooth level site and spread out your tent.

B) Extend main tent poles and place in position ready for installation.

C) Take a pole and slide it through one of the center sleeves, inserting the end into an opening on the 5-way center hub. Repeat this process for each remaining pole.

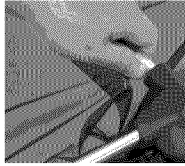

D) After inserting poles into hub, gently flex poles into an arch and secure opposite ends onto pin-rings at base of tent. *Caution: Make sure pole sleeve fabric is evenly distributed along pole and does not catch at pole joints. Undue stress could break pole or tear fabric. Tip: Pin-ring bases have 2 or 3 pins on them. The other pin(s) will be used for side room poles.*

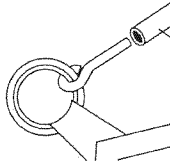

E) Snap Quick Clips (attached to tent body) over each tent pole to shape the tent.

STEP 3: Install the Side and Front Screen Tent Poles

A) Extend side and front screen poles and place in position ready for installation.

B) Slide side poles through side pole sleeves, and secure ends onto pin-rings at base of tent.



C) Slide front screen room pole through front pole sleeves and secure ends onto pin-rings at base of tent.

D) Attach Quick Clips to corresponding poles.

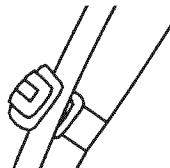

STEP 4: Attach the Rainfly

A) Drape rainfly over tent.

B) Connect each S-hook to corresponding pin-rings or fabric loops.

C) Secure rainfly to tent by wrapping nylon fasteners, located on underside of fly, around each pole.

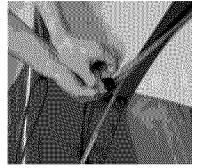

STEP 5: Stake Tent

A) Stake tent by driving stakes through the webbing loops on base of tent.

B) To secure guy lines, find the guy line plastic slider and look for the portion of the line opposite the knot. Pull this portion, forming a loop (works like a slip knot.) Extend guy line to ground and stake. Repeat with remaining guy lines.

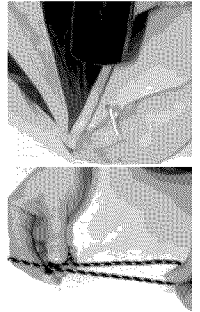

CAMPERS WANT TO KNOW

We bought a four man tent, but found out that the two of us still need more room. Why is that the case?

Tents are advertised as two man, four man, six man and so on. That rating practice and accompanying diagram on the packaging will depict the maximum number of persons you can comfortably bed down for the night, assuming that you travel light or store your gear elsewhere. While this rating makes good sense for backpackers and campers who need little storage space, families and pet owners wanting the "comforts of home" will crave additional elbow room.

A ten by ten foot tent is ideal for two adults with a small infant who want stand up space to change clothes and enough room for cots or a double mattress and a porta-crib. Read the dimensions carefully and – when in doubt – consider jumping up to the next size; you never know when the kids will want to bring a friend along!

DISASSEMBLY INSTRUCTIONS

* Make sure all windows and doors are unzipped to disassemble.

* Store all poles and stakes in their corresponding bags to prevent possible tearing or damage to fabric.

STEP 1: Remove the Stakes

Carefully remove stakes by pulling out the hook ends. Tip: Do not pull or tug at the stake loops sewn onto the fabric body. Remove excess soil from the stakes and store them in their bag.

STEP 2: Remove Rainfly

A) Detach S-hooks and nylon fasteners strips that hold down rainfly.

B) Fold rainfly for storage

STEP 3: Take Down the Tent

A) Unfasten Quick Clips on tent poles.

B) Remove poles from pin-rings and center hub.

C) Slide poles out by carefully pushing them through the

sleeves away from the end at which you are standing. Tip: By following these instructions, you will minimize risk of damaging poles and/or snapping shock-cording.

D) Carefully fold poles and store them in their bag.

STEP 4: Fold the Tent

Fold tent into rectangular shape the width of pole bag. Lay pole bag at one end of tent and roll tightly together, slowly squeezing air out as you go. You can roll rainfly together with tent in this step. Store tent in carry bag provided.

(Following these instructions will make it easier to fit tent into bag.)



Limited 6 Month Warranty

If your product does not work properly because of a defect in materials or workmanship, NorthPole Limited will, for 6 months from the date of purchase, at its option either (a) repair our product with new or refurbished parts, or (b) replace it with a new product. The decision to repair or replace will be made by NorthPole Limited. NORTHPOLE LIMITED RESERVES THE RIGHT TO MAKE SUBSTITUTIONS TO WARRANTY CLAIMS IF PARTS ARE UNAVAILABLE OR OBSOLETE.

If repair is needed during the limited warranty period, the purchaser will be required to furnish a sales receipt as proof of purchase indicating date of purchase, amount paid, and place of purchase. Product will not be covered under warranty due to damages resulting from misuse, excessive or abusive usage, and/or inclement weather conditions (i.e. wind storms, hurricanes, lightning storms, tornadoes). Acts of God resulting in damage to tent and its components are not covered under this limited warranty. In such event, the consumer assumes cost of needed parts. NorthPole Limited is not responsible for normal wear and tear, zipper exhaustion, or the natural breakdown in materials that occurs with extended use.

UNDER NO CIRCUMSTANCES SHALL NORTHPOLE LIMITED BE LIABLE FOR ANY INCIDENTAL OR CONSEQUENTIAL DAMAGES. Some states do not allow the exclusion or limitation of incidental or consequential damages, so the above limitation may not apply to you.

NORTHPOLE LIMITED EXPRESSLY EXCLUDES ALL WARRANTIES, INCLUDING, BUT NOT LIMITED TO, ANY IMPLIED WARRANTIES OF MERCHANTABILITY AND FITNESS FOR A PARTICULAR PURPOSE. Some states do not allow the exclusion or limitation of implied warranties, so the above exclusion may not apply to you.

NOTWITHSTANDING ANYTHING TO THE CONTRARY, NORTHPOLE'S AGGREGATE LIABILITY, WHETHER IN CONTRACT OR TORT, SHALL BE LIMITED TO ACTUAL DIRECT MONEY DAMAGES IN AN AMOUNT NOT TO EXCEED THE PRICE PAID BY THE END-USER FOR THIS PRODUCT.

HOW TO OBTAIN WARRANTY SERVICE: Call the toll free number during the business hours mentioned below. You must have a copy of your purchase receipt from an authorized dealer as proof of purchase at time of call.

HOW TO ORDER REPLACEMENT PARTS: When ordering replacement parts, always include *Model Number, Part Number, and Part Description*.

Call toll free 1 (800) 775-1965 · Mon-Fri, 7:00 a.m. to 5:00 p.m. (Central Standard Time)

